



**TOWN OF NEWBURGH
PLANNING BOARD
TECHNICAL REVIEW COMMENTS**

PROJECT NAME: POPPY LANE
PROJECT NO.: 2021-26
PROJECT LOCATION: SECTION 6, BLOCK 1, LOT 113, 114 &115
REVIEW DATE: 30 DECEMBER 2021
MEETING DATE: 6 JANUARY 2021
PROJECT REPRESENTATIVE: ENGINEERING & SURVEYING PROPERTIES/ROSS WINGLOVITZ, P.E.

1. Previously issued comments for the 21 October 2021 Planning Board meeting should be addressed.
2. Adjoiner's Notices and County Planning referral have been completed on the project.

Respectfully submitted,

MHE Engineering, D.P.C.

A handwritten signature in blue ink that reads 'Patrick J. Hines'.

Patrick J. Hines
Principal

PJH/kbw

NEW YORK OFFICE

33 Airport Center Drive, Suite 202, New Windsor, NY 12553
845-567-3100 | F: 845-567-3232 | mheny@mhepc.com

PENNSYLVANIA OFFICE

111 Wheatfield Drive, Suite 1, Milford, PA 18337
570-296-2765 | F: 570-296-2767 | mhepa@mhepc.com



Montgomery Office:
71 Clinton Street
Montgomery, NY 12549
phone: (845) 457-7727
fax: (845) 457-1899

Warwick Office:
17 River Street
Warwick, NY 10990
phone: (845) 986-7737
fax: (845) 986-0245

www.EngineeringPropertiesPC.com

October 7, 2021

Town of Newburgh Planning Board
21 Hudson Valley Professional Plaza
Newburgh, NY 12550
ATTN: John P. Ewasutyn, Chairman

**RE: W.O. # 1493.01
POPPY LANE
SECTION 6, BLOCK 1, LOTS 113, 114, AND 115, OFF OF LESTER CLARK ROAD
LOTS 2, 3 & 4 OF THE MARTUSCELLO SUBDIVISION, FILED MAP #8866 5/18/1988
APPLICATION TO PLANNING BOARD**

Dear Chair Ewasutyn and members of the Board,

This letter and the attached plans constitute the property owner, Wise Equities Group, LLC's application to the Planning Board pursuant to Section 161-25 of the Town Street Specifications to determine the applicability and if necessary waive certain technical requirements of the street specifications and it relates to the construction of the road to serve the Martuscello subdivision.

The Martuscello subdivision which includes the right-of-way layout of a private road was approved in 1988 and filed in the County Clerks' office on 5/18/1988 as map # 8866. Therefore, all lots are existing lots. As stated above, this filed map depicted the lot layout and the layout for the road, but did not include any road specifications.

The Town Street Specifications Section 161-1B specifically exempts any subdivision approved prior to the adoption of the street specifications in 1991. This subdivision was approved in 1988 prior to adoption of these specifications. The applicant has approached the Town Highway and Building Departments for some guidance on this matter. While the applicant would like to meet the current Town Specifications for Private Roads, it would be impossible to meet all requirements based on the approved subdivision's layout. Specifically, the following specifications cannot be met:

1. §161-15C requires a negative two percent (-2%) grade from the edge of pavement to the start of the right-of-way. Due to the existing grade in the area, it is not feasible to provide this while also providing proper drainage in the area. Specifically, providing the drainage ditches along the private road, required by the private road cross section in §161-16, and providing catch basins to collect the stormwater from the private road and outlet it to daylight.
2. §161-8 requires dead end roads, such as the proposed one, to be provided with a 50-foot diameter cul-de-sac. Due to the length of the proposed road, this would not meet fire access standards, and due to the existing grade in the area, an alternative turnaround is

proposed that would provide sufficient fire truck turnaround space and would fit within the existing right-of-way easement.

We have been advised by the Planning Board and Town Board's engineering consultant via email that we should apply to this board seeking a waiver of these specific conditions. The Town's Highway Specifications do vest the Planning Board with the authority to interpret the street specs via section 161-25 which provides:

"§ 161-25 Interpretation.

Final decision as to the interpretation of any part of these street specifications shall rest with the Town Planning Board, which is hereby empowered, pursuant to Town Law § 280-a, to require private roads to be improved to its satisfaction in accordance with the standards and specifications approved by the Town Board herein."

We also would like to note that §157-1B of the Town stormwater requirements, adopted in 1995 and amended in 2009, states:

"The amended limitations on construction of stormwater management facilities imposed herein specifically do not apply to mapped subdivisions, developments and site plans which have been finally approved by the Town of Newburgh Planning Board or other authorized authority for which a final map has been filed in the office of the Orange County Clerk or Town offices, as required by law. Previously enacted limitations remain in effect for those projects."

Given the facts that:

1. This subdivision predated the adoption of the private road street specifications
2. The construction specifications meet the great majority of the current requirements
3. There will only be 3 lots accessing from the private road which is similar to that permitted access from a shared driveway which would be constructed to lesser specifications
4. The road as proposed will be passable and safe

Based upon all of this we are requesting that the Planning Board authorize construction of this private road based upon the design provided. If you have any additional questions and/or comments, please don't hesitate to contact this office. We have enclosed the following information for your review:

- Plans for the private road (3 sheets), dated 10/7/21
- Application forms signed by the applicant
- Planning Board application checklist
- Checks for application fee of \$700 and escrow of \$2,200
- Short Environmental Assessment Form
- Survey of the property by CV Associates NY
- Original subdivision, filed map # 8866

Poppy Lane

October 7, 2021

Sincerely,
Engineering & Surveying Properties, PC



Ross Winglovitz, P.E.
Principal

Daniel Getz
Project Engineer

cc: Joel Weiss, Wise Equities
John Cappello, Esq

**TOWN OF NEWBURGH
APPLICATION FOR
SUBDIVISION/SITE PLAN REVIEW**

**RETURN TO: Town of Newburgh Planning Board
308 Gardnertown Road
Newburgh, New York 12550**

DATE RECEIVED: _____ TOWN FILE NO: _____
(Application fee returnable with this application)

1. Title of Subdivision/Site Plan (Project name):
Poppy Lane

2. Owner of Lands to be reviewed:

Name Wise Equities Group, LLC
Address 20 Chevron Street, Suite 201
Monroe, NY 10950
Phone (845) 666-9595

3. Applicant Information (If different than owner):

Name (same as owner)
Address _____

Representative Joel Weiss
Phone (845) 666-9595
Fax (845) 704-1309
Email jw@jwconsultinginc.com

4. Subdivision/Site Plan prepared by:

Name Engineering & Surveying Properties, PC
Address 17 River Street
Warwick, NY 10990
Phone/Fax (845) 986-7737 (phone) / (845) 986-0245 (fax)

5. Location of lands to be reviewed:

North of Lester Clark Road, between 114 and 118 Lester Clark Road

6. Zone AR
Acreage 5.93 ±

Fire District Middlehope
School District Marlboro Central

7. Tax Map: Section 6 **Block** 1 **Lot** 113, 114, and 115
also 108.3 4 24.210
in the Town of Marlborough, Ulster County (no disturbance proposed there)

8. Project Description and Purpose of Review:

Number of existing lots 3 Number of proposed lots (no change proposed)
Lot line change _____
Site plan review _____
Clearing and grading _____
Other authorize construction of private road

PROVIDE A WRITTEN SINGLE PAGE DESCRIPTION OR NARRATIVE OF THE PROJECT

9. Easements or other restrictions on property:

(Describe generally) private road right-of-way per filed plat

10. The undersigned hereby requests approval by the Planning Board of the above identified application and scheduling for an appearance on an agenda:

Signature  Title President

Date: 9/30/21

NOTE: If property abuts and has its access to a County or State Highway or road, the following information must be placed on the subdivision map or site plan: entrance location, entrance profile, sizing of pipe (minimum length of pipe to be 24 feet).

The applicant will also be required to submit an additional set of plans, narrative letter and EAF if referral to the Orange County Planning Department is required under General Municipal Law Section 239.

TOWN OF NEWBURGH PLANNING BOARD

Poppy Lane

PROJECT NAME

CHECKLIST FOR MAJOR/MINOR SUBDIVISION AND/OR SITE PLAN

I. The following items shall be submitted with a COMPLETED Planning Board Application Form.

1. Environmental Assessment Form As Required
2. Proxy Statement
3. Application Fees
4. Completed Checklist (Automatic rejection of application without checklist)

II. The following checklist items shall be incorporated on the Subdivision Plat or Site Plan prior to consideration of being placed on the Planning Board Agenda. Non-submittal of the checklist will result in application rejection.

1. Name and address of applicant
2. Name and address of owner (if different from applicant)
3. Subdivision or Site Plan and Location
4. Tax Map Data (Section-Block-Lot)
5. Location map at a scale of 1" = 2,000 ft. or less on a tax map or USCGS map base only with property outlined
6. N/A Zoning table showing what is required in the particular zone and what applicant is proposing. A table is to be provided for each proposed lot
7. N/A Show zoning boundary if any portion of proposed site is within or adjacent to a different zone
8. Date of plan preparation and/or plan revisions
9. Scale the plan is drawn to (Max 1" = 100')
10. North Arrow pointing generally up

11. Surveyor,s Certification
12. Surveyor's seal and signature
13. Name of adjoining owners
14. N/A Wetlands and 100 ft. buffer zone with an appropriate note regarding D.E.C. or A.C.O.E. requirements
15. N/A Flood plain boundaries
16. N/A Certified sewerage system design and placement by a Licensed Professional Engineer must be shown on plans in accordance with Local Law #1 1989
17. Metes and bounds of all lots
18. Name and width of adjacent streets; the road boundary is to be a minimum of 25 ft. from the physical center line of the street
19. Show existing or proposed easements (note restrictions)
20. Right-of-way width and Rights of Access and Utility Placement
21. Road profile and typical section (minimum traveled surface, excluding shoulders, is to be 18 ft. wide)
22. N/A Lot area (in sq. ft. for each lot less than 2 acres)
23. N/A Number of lots including residual lot
24. N/A Show any existing waterways
25. A note stating a road maintenance agreement is to be filed in the County Clerk's Office where applicable
26. TBP Applicable note pertaining to owners review and concurrence with plat together with owner's signature
27. Show any improvements, i.e. drainage systems, water lines, sewer lines, etc.
28. Show all existing houses, accessory structures, wells and septic systems on and within 200 ft. of the parcel to be subdivided
29. Show topographical data with 2 or 5 ft. contours on initial submission

30. Indicate any reference to a previous subdivision, i.e. filed map number, date and previous lot number
31. TBP If a private road, Town Board approval of name is required, and notes on the plan that no town services will be provided and a street sign (per town specs) is to be furnished and installed
32. Number of acres to be cleared or timber harvested
33. TBP Estimated or known cubic yards of material to be excavated and removed from the site
34. TBP Estimated or known cubic yards of fill required
35. The amount of grading expected or known to be required to bring the site to readiness
36. N/A Type and amount of site preparation which falls within the 100 ft. buffer strip of wetlands or within the Critical Environmental Area. Please explain in sq. ft. or cubic yards.
-
-
37. N/A Any amount of site preparation within a 100 year floodplain or any water course on the site. Please explain in sq. ft. or cubic yards.
-
-
38. TBP List of property owners within 500 feet of all parcels to be developed (see attached statement).

The plan for the proposed subdivision or site has been prepared in accordance with this checklist.

By:  _____
Licensed Professional

Date: 10/7/21 _____

This list is designed to be a guide ONLY. The Town of Newburgh Planning Board may require additional notes or revisions prior to granting approval.

Prepared (insert date):

**TOWN OF NEWBURGH
APPLICATION FOR CLEARING AND GRADING**

Name of applicant: Wise Equities Group, LLC c/o Joel Weiss

Name of owner on premises: (same as applicant)

Address of owner: 20 Chevron Street, Suite 201, Monroe NY 10950

Telephone number of owner: (845) 666-9595

Telephone number of applicant: _____

State whether applicant is owner, lessee, agent, architect, engineer or contractor:
owner

Location of land on which proposed work will be done: off Lester Clark Road
on the north side, between house numbers 114 and 118

Section: 6 **Block:** 1 **Lot:** 113, 114, & 115 Sub. Div.: _____

Zoning District of Property: AR **Size of Lot:** 5.93 acres ± total

Area of lot to be cleared or graded: 3.5 acres ±

Proposed completion of date: TBD

Name of contractor/agent, if different than owner: _____

Address: _____

Telephone number: _____

Date of Planning Board Approval: _____ (if required)

I hereby agree to hold the Town of Newburgh harmless from any claims arising from the proposed activity.

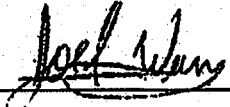
Signature of owner:  **Date:** 9/30/21

Signature of applicant (if different than owner): _____

TOWN ACTION:

Examined: _____ 20 _____

Approved: _____ 20 _____

Disapproved: _____ 20 _____

FEE LAW SUMMARY

PENDING APPLICATIONS

All applicants with matters pending before the Planning Board as of the effective date of this local law shall be required to post as escrow in the manner and upon the terms and conditions set forth below:

- (a) The Planning Board, in consultation with the applicant, shall compute the amount of the escrow to be posted with the Town. Such amount shall be reasonably related to the costs attendant to the Town's review of the application as of the effective date of this local law. Under no circumstances shall the escrow include amounts attributable to any costs incurred by the Town prior to the effective date of this local law.
- (b) Once computed and established by Resolution of the Planning Board, the applicant shall, within fifteen (15) days of said resolution, post escrow fees with the Secretary of the Planning Board. Failure to deliver the said escrow fees may result in delay of the further processing of the application.

SEVERABILITY

In the event a court of law determined that any provision of this chapter is unenforceable, then only that provision shall be affected and all other provisions shall be fully enforceable.

EFFECTIVE DATE:

This local law shall take effect immediately upon filing in the Office of the Secretary of State.

FEE ACKNOWLEDGEMENT

The town of Newburgh Municipal Code sets forth the schedule of fees for applications to the Planning Board. The signing of this application indicates your acknowledgement of responsibility for payment of these fees to the Planning Board for review of this application, including, but not limited to escrow fees for professional services (planner/consultant, engineering, legal), public hearing and site inspection. Applicant's submissions and resubmissions are not complete and will not be considered by the planning board or placed upon its agenda unless all outstanding fees have been paid. Fees incurred after the stamping of plans will remain the responsibility of the applicant prior to approval of a building permit or certificate of occupancy. Fee schedules are available from the Planning Board Secretary and are on the Town's website.

Joel Weiss

APPLICANT'S NAME (printed)

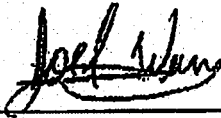

APPLICANTS SIGNATURE

9/30/21

DATE

Note: if the property abuts and has access to a County or State Highway or road, the following information must be place on the subdivision map: entrance location, entrance profile, sizing of drainage pipe (minimum length of pipe to be twenty-four (24) feet).

PLANNING BOARD DISCLAIMER STATEMENT
TO APPLICANTS

The applicant is advised that the Town of Newburgh Municipal Code, which contains the Town's Zoning Law, is subject to amendment. Submission of an application to this Board does not grant the applicant any right to continued review under the Code's current standards and requirements. It is possible that the applicant will be required to meet changed standards or new Code requirements made while the application is pending.

An approval by this Board does not constitute permission, nor grant any right to connect to or use municipal services such as sewer, water or roads. It is the applicant's responsibility to apply for and obtain the Town of Newburgh and other agency approvals not within this Board's authority to grant.

The applicant hereby acknowledges, consents, and agrees to the above.

9/30/21

DATED

Joel Weiss

APPLICANT'S NAME (printed)

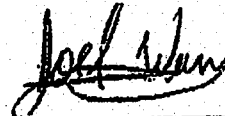

APPLICANT'S SIGNATURE

**DISCLOSURE ADDENDUM STATEMENT TO APPLICATION,
PETITION AND REQUEST**

Mindful of the provisions of Section 809 of the General Municipal Law of the State of New York, and of the Penal provisions thereof as well, the undersigned applicant states that no State Officer, Officer or Employee of the Town of Newburgh, or Orange County, has any interest, financial or otherwise, in this application or with, or in the applicant as defined in said Statute, except the following person or persons who is or are represented to have only the following type of interest, in the nature and to the extent hereinafter indicated:

NONE

_____ **NAME, ADDRESS, RELATIONSHIP OR INTEREST**
(financial or otherwise)

This disclosure addendum statement is annexed to and made a part of the petition, application and request made by the undersigned applicant to the following Board or Officer of the Town of Newburgh.

_____ **TOWN BOARD**
 PLANNING BOARD
_____ **ZONING BOARD OF APPEALS**
_____ **ZONING ENFORCEMENT OFFICER**
_____ **BUILDING INSPECTOR**
_____ **OTHER**

9/30/21

DATED

_____ **INDIVIDUAL APPLICANT**

Wise Equities Group, LLC
CORPORATE OR PARTNERSHIP APPLICANT

BY: Joel Weiss

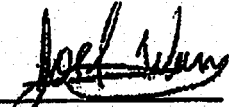
 (Pres.) (Partner) (Vice-Pres.)
(Sec.) (Treas.)

AGRICULTURAL DATA STATEMENT

(Required pursuant to Agricultural and Markets Law §305-a for applications for site plan approvals, use variances and subdivision approvals that will occur on property within a County Agricultural District containing an active farm operation or on property with boundaries within five hundred feet of an active farm operation located in a County Agricultural District)

Name and address of the applicant: Wise Equities Group, LLC
20 Chevron Road, Suite 201
Monroe, NY 10950

Description of the proposed project: construction of private road

Location of the proposed project: North side of Lester Clark Road, between house
numbers 114 and 118

Name(s) and address(es) of any owner(s) of land within a County Agricultural District containing active farming operations and located within five hundred feet of the boundary of the project property: none

A tax map or other map showing the site of the proposed project relative to the location of the identified farm operations must be attached to this form.

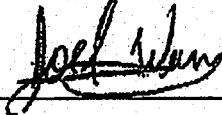

APPLICANT'S SIGNATURE

9/30/21

DATE

PROXY

(OWNER) Joel Weiss, DEPOSES AND SAYS THAT HE/SHE

RESIDES AT 20 chevron rd #201 Monroe NY 10950

IN THE COUNTY OF Orange

AND STATE OF new York

AND THAT HE/SHE IS THE OWNER IN FEE OF Section 6, Block 1, Tax Lots 113, 114, and 115 in the Town of Newburgh, off of Lester Clark Road

WHICH IS THE PREMISES DESCRIBED IN THE FOREGOING APPLICATION AS DESCRIBED THEREIN TO THE TOWN OF NEWBURGH PLANNING BOARD AND Engineering & Surveying Properties, PC IS AUTHORIZED TO REPRESENT THEM AT MEETINGS OF SAID BOARD.

DATED: 10/6/2021

[Signature]
OWNERS SIGNATURE

Joel Weiss
OWNERS NAME (printed)

[Signature]
WITNESS' SIGNATURE

NAMES OF ADDITIONAL REPRESENTATIVES

Aaron Appel
WITNESS' NAME (printed)

Signed & affirmed
10-6-2021 [Signature]

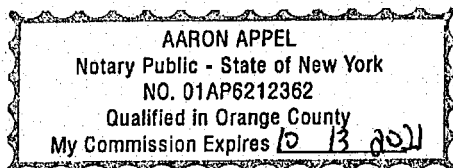

Short Environmental Assessment Form

Part 1 - Project Information

Instructions for Completing

Part 1 – Project Information. The applicant or project sponsor is responsible for the completion of Part 1. Responses become part of the application for approval or funding, are subject to public review, and may be subject to further verification. Complete Part 1 based on information currently available. If additional research or investigation would be needed to fully respond to any item, please answer as thoroughly as possible based on current information.

Complete all items in Part 1. You may also provide any additional information which you believe will be needed by or useful to the lead agency; attach additional pages as necessary to supplement any item.

Part 1 – Project and Sponsor Information			
Name of Action or Project: Poppy Lane			
Project Location (describe, and attach a location map): Between 114 and 118 Lester Clark Road, Town of Newburgh Tax Lots 6-1-113, 114, and 115, including Town of Marlborough 108.3-4-24.1			
Brief Description of Proposed Action: Applicant requests authorization to construct a private road to serve three proposed 4-bedroom single-family residential dwellings. The properties are Lots 2, 3 and 4 of the Martuscello Subdivision filed in 1988, which proposed a private road.			
Name of Applicant or Sponsor: Wise Equities Group, LLC		Telephone: 845-666-9595 E-Mail: jw@jwconsultinginc.com	
Address: 20 Chevron Street			
City/PO: Monroe		State: NY	Zip Code: 10950
1. Does the proposed action only involve the legislative adoption of a plan, local law, ordinance, administrative rule, or regulation? If Yes, attach a narrative description of the intent of the proposed action and the environmental resources that may be affected in the municipality and proceed to Part 2. If no, continue to question 2.			NO <input type="checkbox"/>
2. Does the proposed action require a permit, approval or funding from any other government Agency? If Yes, list agency(s) name and permit or approval:			YES <input type="checkbox"/>
3. a. Total acreage of the site of the proposed action? b. Total acreage to be physically disturbed? c. Total acreage (project site and any contiguous properties) owned or controlled by the applicant or project sponsor?			NO <input checked="" type="checkbox"/>
			YES <input checked="" type="checkbox"/>
		5.93 ± acres	
		3.3 ± acres	
		5.93 ± acres	
4. Check all land uses that occur on, are adjoining or near the proposed action:			
5. <input type="checkbox"/> Urban <input checked="" type="checkbox"/> Rural (non-agriculture) <input type="checkbox"/> Industrial <input type="checkbox"/> Commercial <input checked="" type="checkbox"/> Residential (suburban) <input checked="" type="checkbox"/> Forest <input type="checkbox"/> Agriculture <input type="checkbox"/> Aquatic <input type="checkbox"/> Other(Specify): <input type="checkbox"/> Parkland			

5. Is the proposed action,	NO	YES	N/A
a. A permitted use under the zoning regulations?	<input type="checkbox"/>	<input checked="" type="checkbox"/>	<input type="checkbox"/>
b. Consistent with the adopted comprehensive plan?	<input type="checkbox"/>	<input checked="" type="checkbox"/>	<input type="checkbox"/>
6. Is the proposed action consistent with the predominant character of the existing built or natural landscape?	NO <input type="checkbox"/>	YES <input checked="" type="checkbox"/>	
7. Is the site of the proposed action located in, or does it adjoin, a state listed Critical Environmental Area? If Yes, identify: _____	NO <input checked="" type="checkbox"/>	YES <input type="checkbox"/>	
8. a. Will the proposed action result in a substantial increase in traffic above present levels?	NO <input checked="" type="checkbox"/>	YES <input type="checkbox"/>	
b. Are public transportation services available at or near the site of the proposed action?	<input checked="" type="checkbox"/>	<input type="checkbox"/>	
c. Are any pedestrian accommodations or bicycle routes available on or near the site of the proposed action?	<input checked="" type="checkbox"/>	<input type="checkbox"/>	
9. Does the proposed action meet or exceed the state energy code requirements? If the proposed action will exceed requirements, describe design features and technologies: _____ _____	NO <input type="checkbox"/>	YES <input checked="" type="checkbox"/>	
10. Will the proposed action connect to an existing public/private water supply? If No, describe method for providing potable water: _____ new individual private wells _____	NO <input checked="" type="checkbox"/>	YES <input type="checkbox"/>	
11. Will the proposed action connect to existing wastewater utilities? If No, describe method for providing wastewater treatment: _____ new individual subsurface sewage disposal systems (designs previously submitted to the building department) _____	NO <input checked="" type="checkbox"/>	YES <input type="checkbox"/>	
12. a. Does the project site contain, or is it substantially contiguous to, a building, archaeological site, or district which is listed on the National or State Register of Historic Places, or that has been determined by the Commissioner of the NYS Office of Parks, Recreation and Historic Preservation to be eligible for listing on the State Register of Historic Places?	NO <input checked="" type="checkbox"/>	YES <input type="checkbox"/>	
b. Is the project site, or any portion of it, located in or adjacent to an area designated as sensitive for archaeological sites on the NY State Historic Preservation Office (SHPO) archaeological site inventory?	<input checked="" type="checkbox"/>	<input type="checkbox"/>	
13. a. Does any portion of the site of the proposed action, or lands adjoining the proposed action, contain wetlands or other waterbodies regulated by a federal, state or local agency? b. Would the proposed action physically alter, or encroach into, any existing wetland or waterbody? If Yes, identify the wetland or waterbody and extent of alterations in square feet or acres: _____ _____ _____	NO <input type="checkbox"/>	YES <input checked="" type="checkbox"/>	

14. Identify the typical habitat types that occur on, or are likely to be found on the project site. Check all that apply:		
<input type="checkbox"/> Shoreline <input checked="" type="checkbox"/> Forest <input type="checkbox"/> Agricultural/grasslands <input type="checkbox"/> Early mid-successional <input type="checkbox"/> Wetland <input type="checkbox"/> Urban <input checked="" type="checkbox"/> Suburban		
15. Does the site of the proposed action contain any species of animal, or associated habitats, listed by the State or Federal government as threatened or endangered?	NO	YES
	<input checked="" type="checkbox"/>	<input type="checkbox"/>
16. Is the project site located in the 100-year flood plan?	NO	YES
	<input checked="" type="checkbox"/>	<input type="checkbox"/>
17. Will the proposed action create storm water discharge, either from point or non-point sources?	NO	YES
If Yes,	<input type="checkbox"/>	<input checked="" type="checkbox"/>
a. Will storm water discharges flow to adjacent properties?	<input type="checkbox"/>	<input checked="" type="checkbox"/>
b. Will storm water discharges be directed to established conveyance systems (runoff and storm drains)?	<input checked="" type="checkbox"/>	<input type="checkbox"/>
If Yes, briefly describe: _____ _____		
18. Does the proposed action include construction or other activities that would result in the impoundment of water or other liquids (e.g., retention pond, waste lagoon, dam)?	NO	YES
If Yes, explain the purpose and size of the impoundment: _____ _____	<input checked="" type="checkbox"/>	<input type="checkbox"/>
19. Has the site of the proposed action or an adjoining property been the location of an active or closed solid waste management facility?	NO	YES
If Yes, describe: _____ _____	<input checked="" type="checkbox"/>	<input type="checkbox"/>
20. Has the site of the proposed action or an adjoining property been the subject of remediation (ongoing or completed) for hazardous waste?	NO	YES
If Yes, describe: _____ _____	<input checked="" type="checkbox"/>	<input type="checkbox"/>

I CERTIFY THAT THE INFORMATION PROVIDED ABOVE IS TRUE AND ACCURATE TO THE BEST OF MY KNOWLEDGE

Engineer for the Applicant

Applicant/sponsor name: Ross Winglovitz, PE

Date: 10-07-1964

Signature: 

Title: Engineer for the Applicant

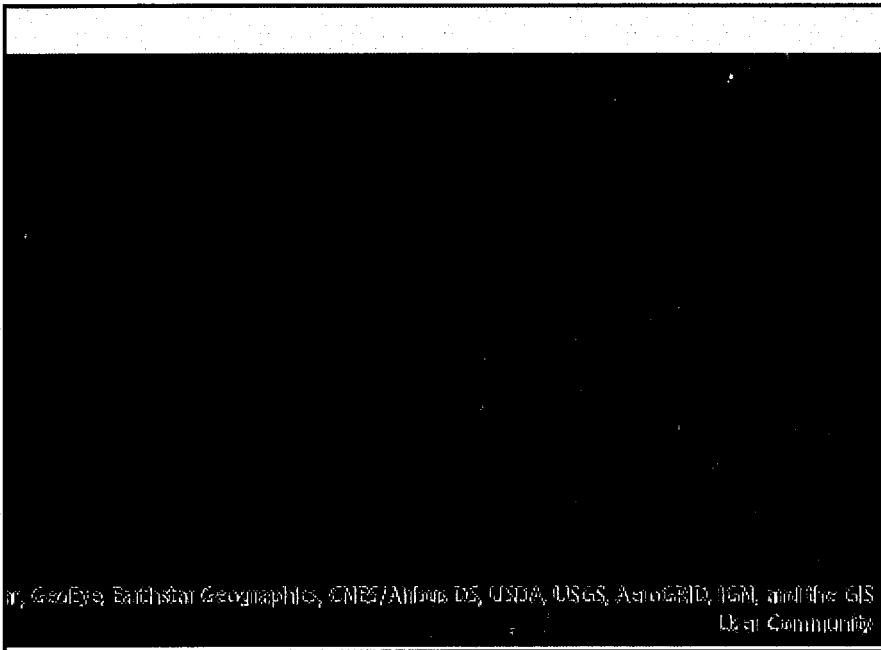

Disclaimer: The EAF Mapper is a screening tool intended to assist project sponsors and reviewing agencies in preparing an environmental assessment form (EAF). Not all questions asked in the EAF are answered by the EAF Mapper. Additional information on any EAF question can be obtained by consulting the EAF Workbooks. Although the EAF Mapper provides the most up-to-date digital data available to DEC, you may also need to contact local or other data sources in order to obtain data not provided by the Mapper. Digital data is not a substitute for agency determinations.

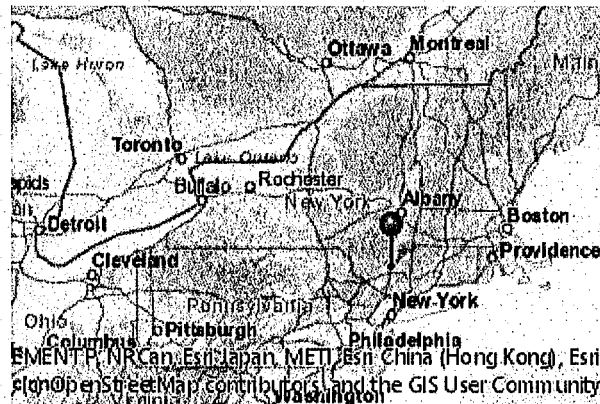

Part 1 / Question 7 [Critical Environmental Area]	No
Part 1 / Question 12a [National or State Register of Historic Places or State Eligible Sites]	No
Part 1 / Question 12b [Archeological Sites]	No
Part 1 / Question 13a [Wetlands or Other Regulated Waterbodies]	Yes - Digital mapping information on local and federal wetlands and waterbodies is known to be incomplete. Refer to EAF Workbook.
Part 1 / Question 15 [Threatened or Endangered Animal]	No
Part 1 / Question 16 [100 Year Flood Plain]	No
Part 1 / Question 20 [Remediation Site]	No

LEGEND

- - - - - EXISTING TOPOGRAPHIC CONTOUR
- (101) PROPOSED GRADING
- _____ PROPERTY LINE
- ADJACENT PROPERTY LINE
- ~~~~~ APPROXIMATE EXISTING TREELINE
- PROPOSED LIMITS OF DISTURBANCE

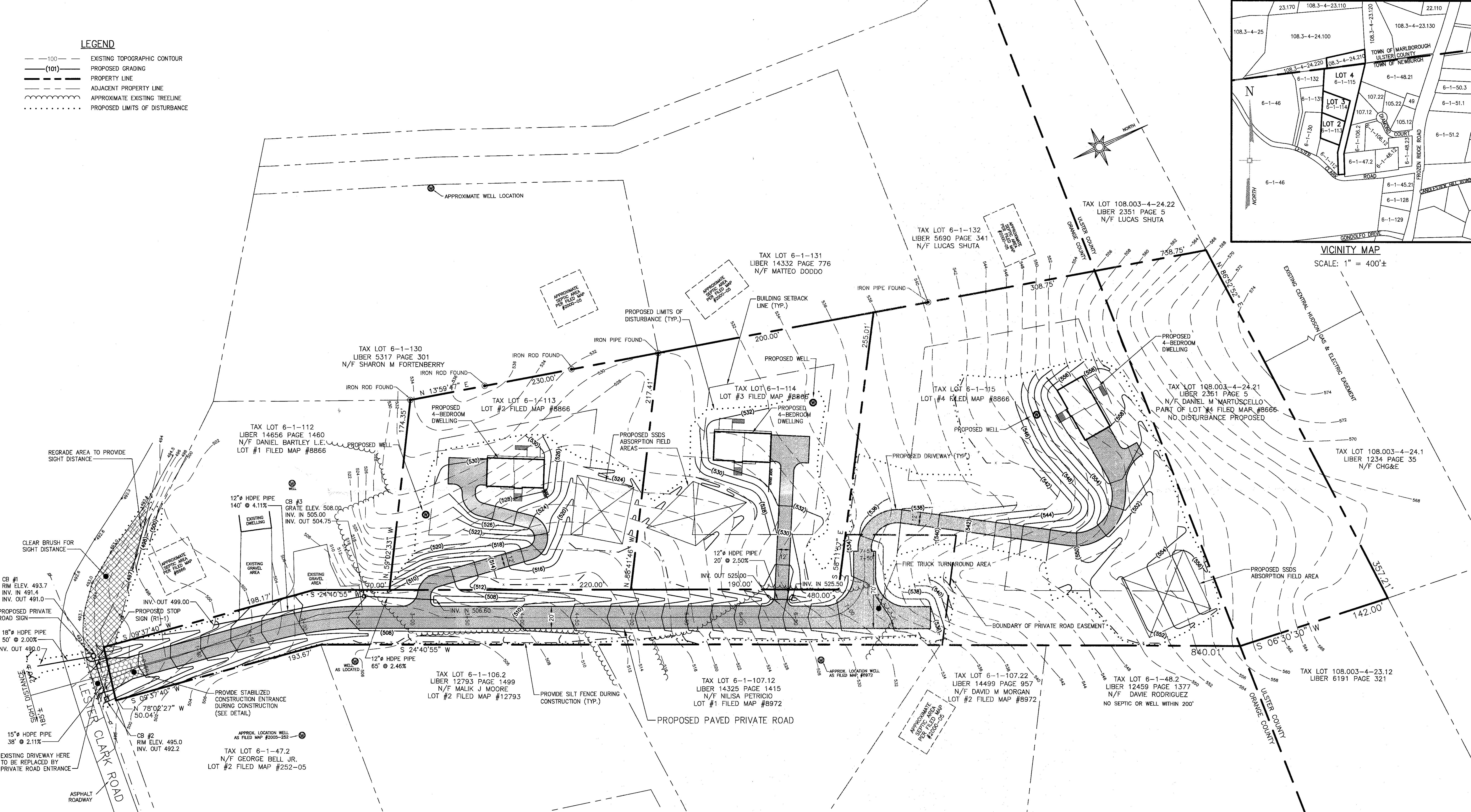
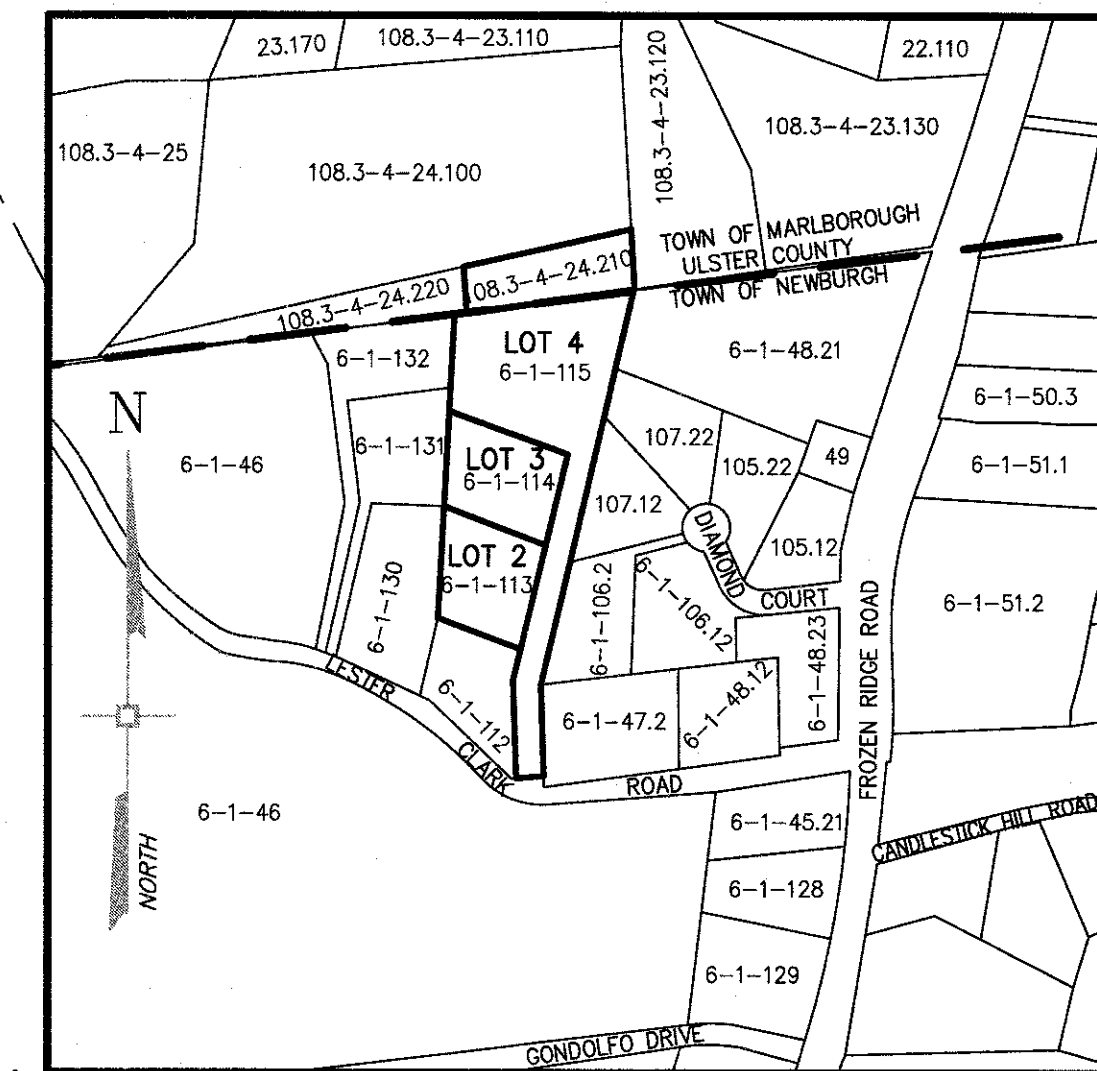

- GENERAL NOTES:**
- TAX MAP DESIGNATION: SECTION 6, BLOCK 1, LOTS 113, 114, & 115 LOTS NUMBER 2, 3, AND 4 OF THE LANDS OF PHOEBE E. MARTUSCELLO MINOR SUBDIVISION, FILED MAY 18, 1988 AS MAP #8866
 - OWNER/APPLICANT:
WISE EQUITIES GROUP LLC
20 CHEVRON STREET, SUITE 201
MONROE, NY 10950
 - ZONING DISTRICT: AR
 - BASED ON A SURVEY BY CV ASSOCIATES NY DATED 10/12/2020, AND ON FILED MAP #8866.
 - THERE ARE NO REGULATED FLOOD PLAINS WITHIN 300 FEET OF THE PROJECT SITE. PER THE NATIONAL FLOOD INSURANCE RATE MAPS NUMBER 36071C0133E AND 36071C0134E FOR ORANGE COUNTY, NY EFFECTIVE 8/03/09.
 - PROPOSED USE: NEW SINGLE-FAMILY RESIDENTIAL DWELLINGS. REFER TO SEPARATE PLANS FOR PROPOSED RESIDENTIAL CONSTRUCTION AND UTILITIES.
 - LIMITS OF DISTURBANCE FOR ALL PROPOSED CONSTRUCTION: 3.3 ACRES ±

- UTILITY NOTES:**
- THE CONTRACTOR SHALL VERIFY THE LOCATION OF ALL EXISTING UTILITY LINES, WHETHER IN THE PUBLIC RIGHT-OF-WAY, IN EASEMENTS, OR IN PRIVATE PROPERTY PRIOR TO STARTING ANY EXCAVATION. THE CONTRACTOR SHALL BE RESPONSIBLE FOR THE PROTECTION OF ALL UTILITY LINES THROUGHOUT THE COURSE OF CONSTRUCTION. PROJECT SAFETY SHALL BE THE SOLE RESPONSIBILITY OF THE CONTRACTOR.
 - DIG SAFELY NEW YORK MUST BE CONTACTED 2 FULL WORKING DAYS PRIOR TO ANY EXCAVATION OR DEMOLITION, BY DIALING 811 OR AT www.digsafelynewyork.com.

No.	DATE	DESCRIPTION

DRAWING STATUS	ISSUE DATE:
THIS SHEET IS PART OF THE PLAN SET ISSUED FOR:	10/7/21
<input type="checkbox"/> CONCEPT APPROVAL	N/A OF N/A
<input checked="" type="checkbox"/> PLANNING BOARD APPROVAL	1 OF 3
<input type="checkbox"/> OGDCH REALTY SUBDIVISION APPROVAL	N/A OF N/A
<input type="checkbox"/> OGDCH WATERMAIN EXTENSION APPROVAL	N/A OF N/A
<input type="checkbox"/> NYSDEC APPROVAL	N/A OF N/A
<input type="checkbox"/> NYSDOT APPROVAL	N/A OF N/A
<input type="checkbox"/> OTHER	N/A OF N/A
<input type="checkbox"/> FOR BID	N/A OF N/A
<input checked="" type="checkbox"/> FOR CONSTRUCTION	N/A OF N/A

COPIES OF THIS DOCUMENT WITHOUT AN ACTUAL OR FACSIMILE OF THE ENGINEER'S SIGNATURE AND AN ORIGINAL STAMP IN RED OR BLUE INK SHALL BE CONSIDERED INVALID.

UNAUTHORIZED ALTERATIONS OR ADDITIONS TO THIS DOCUMENT BEARING THE SEAL OF A LICENSED PROFESSIONAL ENGINEER IS A VIOLATION OF SECTION 7209 SUBSECTION 2 OF THE NEW YORK STATE EDUCATION LAW.



ROSS WINGLOVITZ, P.E.
NEW YORK LICENSE # 071701

1" = 40'

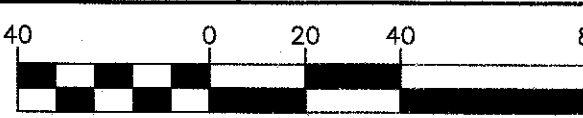

ENGINEERING & SURVEYING PROPERTIES
Achieving Successful Results with Innovative Designs

WARWICK OFFICE
17 RIVER STREET
WARWICK, NY 10990
Ph: (845) 986-7737
WWW.EP-PC.COM

PRIVATE ROAD PLAN

POPPY LANE
LESTER CLARK ROAD
TOWN OF NEWBURGH
ORANGE COUNTY, NEW YORK

JOB #: 1493.01 DRAWN BY: DJG
DATE: 10/7/21 SCALE: 1" = 40'
REVISION: 0 TAX LOTS: 6-1-113, 114 & 115

C-1

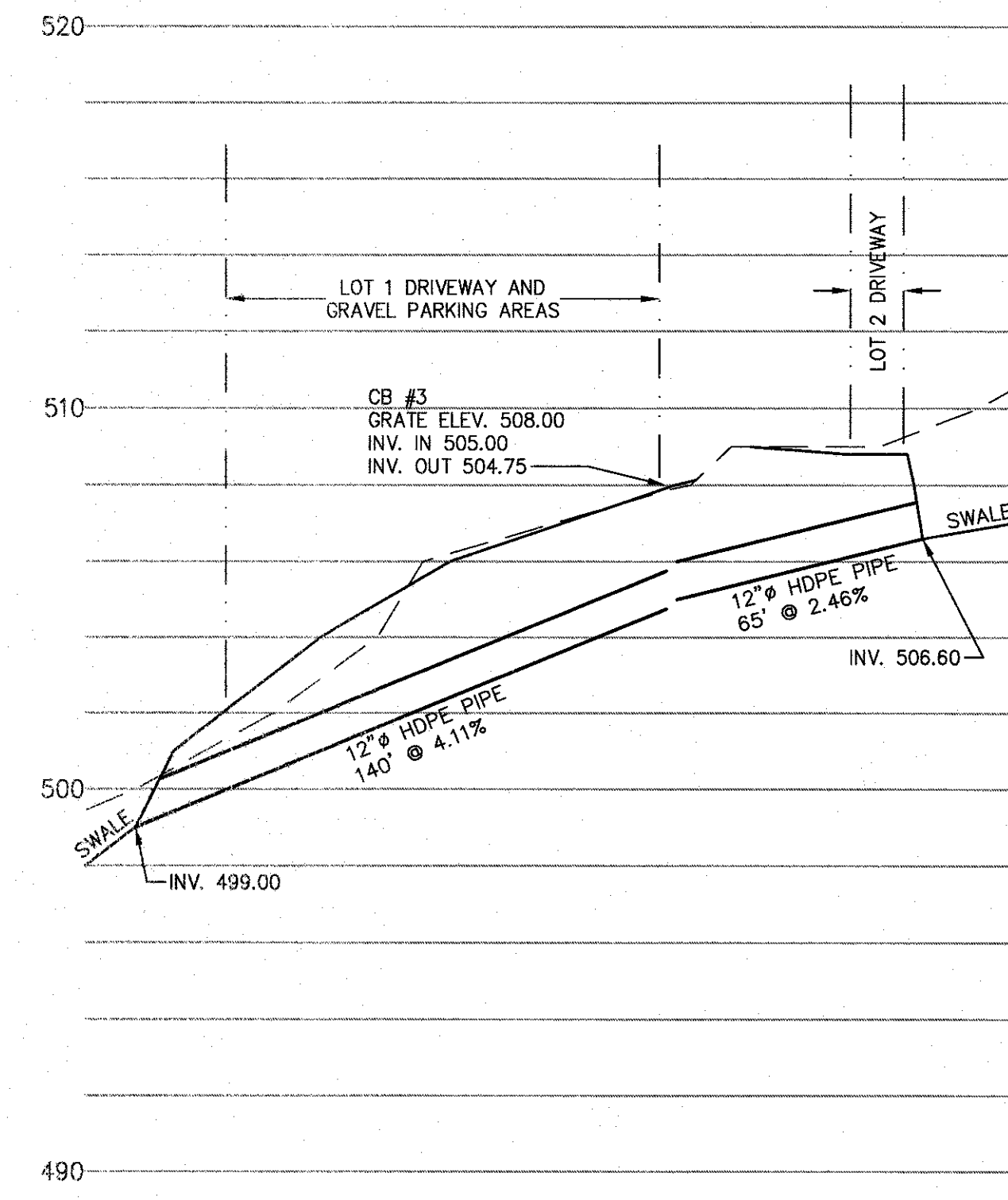
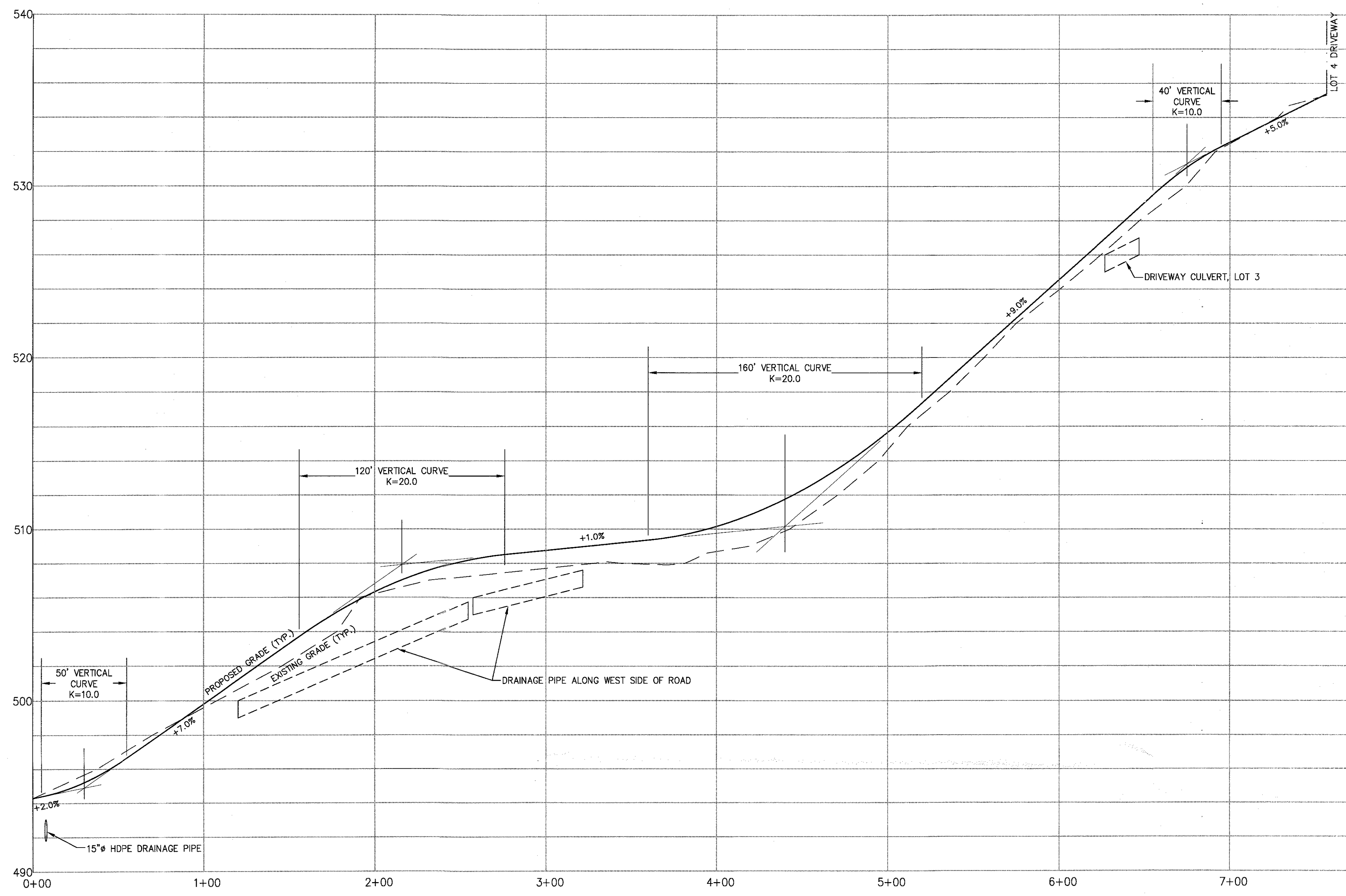

PRIVATE ROAD PROFILE

DRAINAGE PROFILE AT DRIVEWAYS FOR LOTS 1 & 2

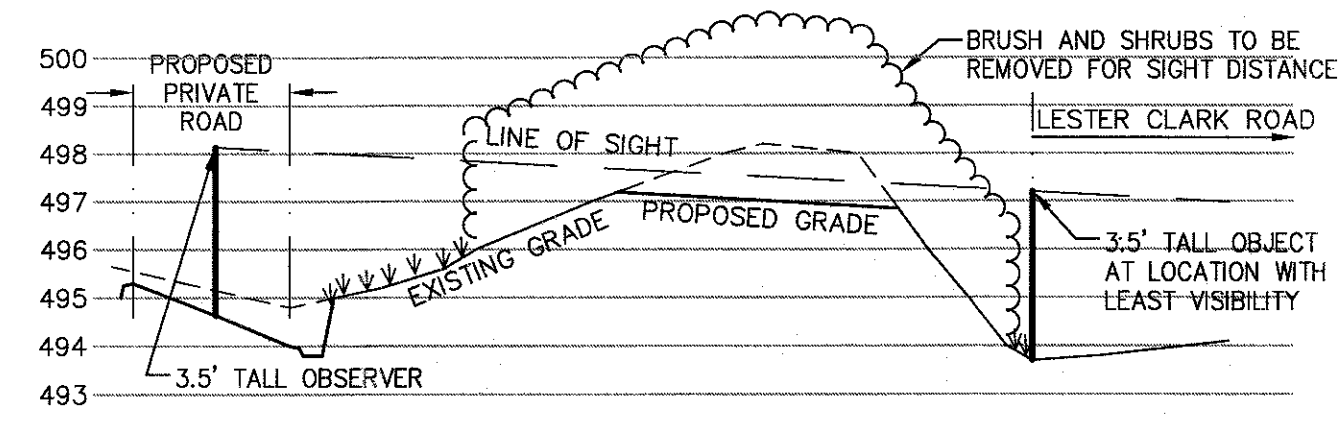

LINE OF SIGHT PROFILE - PRIVATE ROAD ENTRANCE

No.	DATE	DESCRIPTION

DRAWING STATUS		ISSUE DATE:
THIS SHEET IS PART OF THE PLAN SET ISSUED FOR		10/7/21
<input type="checkbox"/> CONCEPT APPROVAL	N/A OF N/A	SHEET NUMBER
<input checked="" type="checkbox"/> PLANNING BOARD APPROVAL	2 OF 3	
<input type="checkbox"/> OCDOH REALTY SUBDIVISION APPROVAL	N/A OF N/A	
<input type="checkbox"/> OCDOH WATERMAIN EXTENSION APPROVAL	N/A OF N/A	
<input type="checkbox"/> NYSDEC APPROVAL	N/A OF N/A	
<input type="checkbox"/> NYSDOT APPROVAL	N/A OF N/A	
<input type="checkbox"/> OTHER	N/A OF N/A	
<input type="checkbox"/> FOR BID	N/A OF N/A	
<input type="checkbox"/> FOR CONSTRUCTION	N/A OF N/A	
THIS PLAN SET HAS BEEN ISSUED SPECIFICALLY FOR THE APPROVAL OR ACTION NOTED ABOVE AND SHALL NOT BE USED FOR ANY OTHER PURPOSE. THIS SHEET SHALL BE CONSIDERED INVALID UNLESS ACCOMPANIED BY ALL SHEETS OF THE DENOTED PLAN SET(S).		

COPIES OF THIS DOCUMENT WITHOUT AN ACTUAL OR FACSIMILE OF THE ENGINEER'S SIGNATURE AND AN ORIGINAL STAMP IN RED OR BLUE INK SHALL BE CONSIDERED INVALID.

ROSS WINGLOVITZ, P.E.
NEW YORK LICENSE # 071701

UNAUTHORIZED ALTERATIONS OR ADDITIONS TO THIS DOCUMENT BEARING THE SEAL OF A LICENSED PROFESSIONAL ENGINEER IS A VIOLATION OF SECTION 7209 SUBSECTION 2 OF THE NEW YORK STATE EDUCATION LAW.

1" = 40'

ENGINEERING & SURVEYING PROPERTIES
Achieving Successful Results with Innovative Designs

WARWICK OFFICE
17 RIVER STREET
WARWICK, NY 10990
Ph: (845) 986-7737
WWW.EP-PC.COM

PROFILES

POPPY LANE
LESTER CLARK ROAD
TOWN OF NEWBURGH
ORANGE COUNTY, NEW YORK

JOB #:	1493.01	DRAWN BY:	DJG
DATE:	10/7/21	SCALE:	1" = 40' HORIZONTAL 1" = 4' VERTICAL
REVISION:	0	TAX LOTS:	6-1-113, 114 & 115

C-2

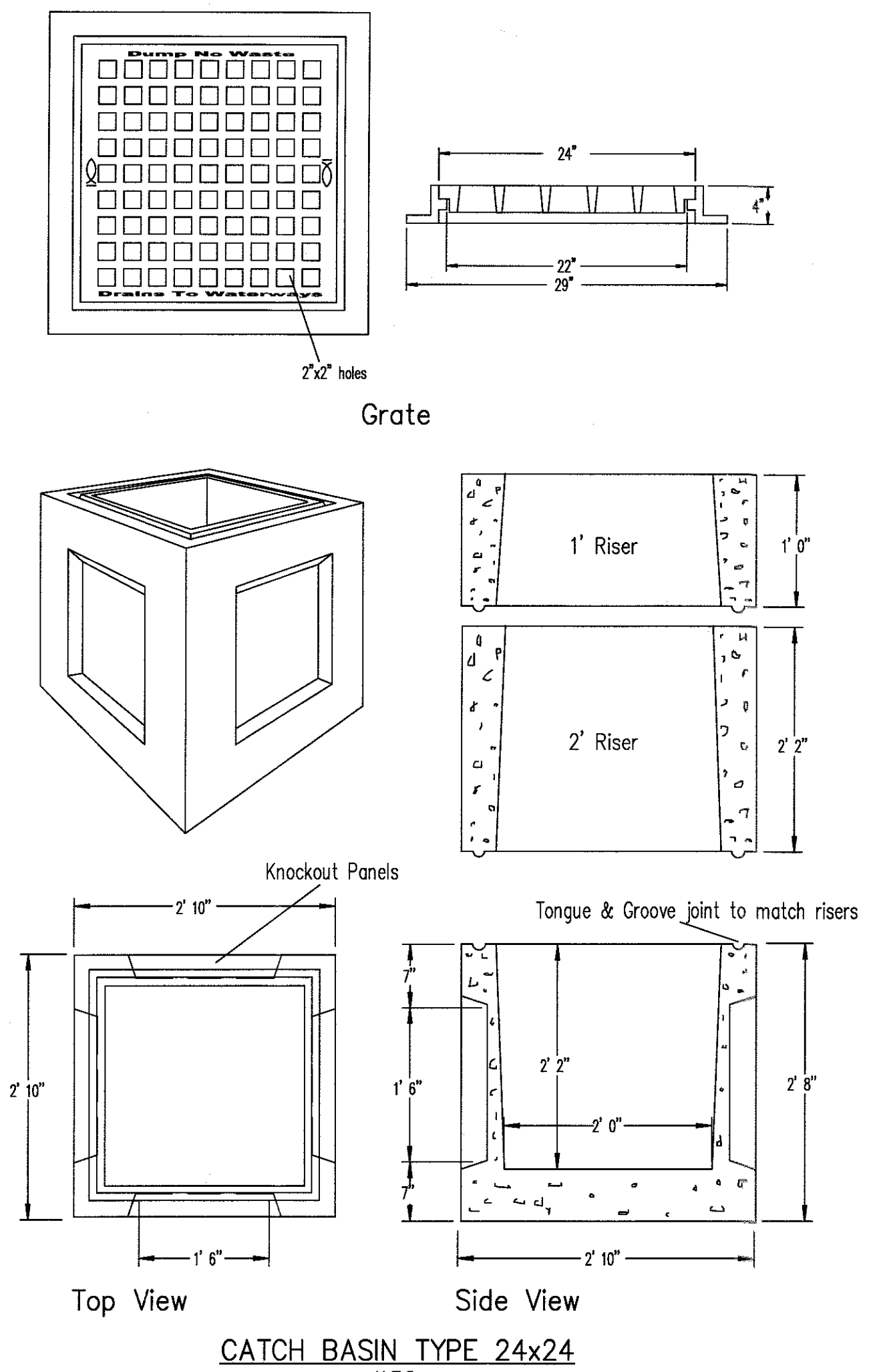

CATCH BASIN TYPE 24x24
N.T.S.

- CATCH BASIN SHALL BE PRECAST CONCRETE MODEL CB-2x2 AS MANUFACTURED BY WOODARD'S CONCRETE PRODUCTS, INC., BULLVILLE, NY, OR APPROVED EQUAL.
- CONCRETE MIN. STRENGTH: 4,000 PSI AT 28 DAYS.
- STEEL REINFORCEMENT: #4 REBAR / ASTM A615.
- CONSTRUCTION JOINT: SEALED WITH BUTYL RUBBER SEALANT OR EQUIVALENT.
- LOAD RATING: H20 / ASTM C857.
- GRATE SHALL BE WOODARD'S CONCRETE PRODUCTS CAST IRON FRAME AND GRATE MODEL GRATE-24x24x4 OR APPROVED EQUAL.

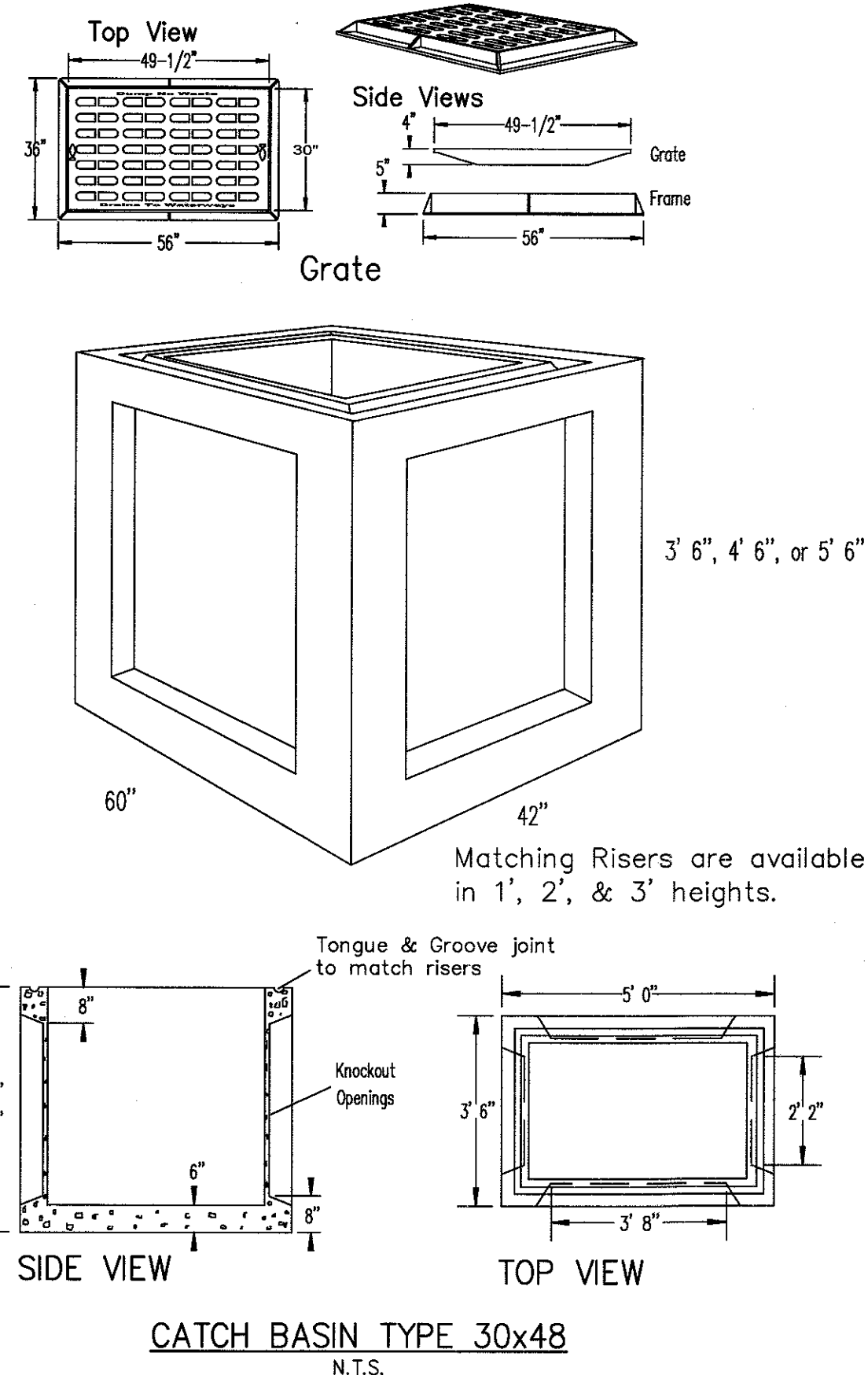

CATCH BASIN TYPE 30x48
N.T.S.

- CATCH BASIN SHALL BE PRECAST CONCRETE MODEL CB-30x48 AS MANUFACTURED BY WOODARD'S CONCRETE PRODUCTS, INC., BULLVILLE, NY, OR APPROVED EQUAL.
- CONCRETE MIN. STRENGTH: 4,000 PSI AT 28 DAYS.
- STEEL REINFORCEMENT: #4 REBAR / ASTM A615.
- CONSTRUCTION JOINT: SEALED WITH BUTYL RUBBER SEALANT OR EQUIVALENT.
- LOAD RATING: H20 / ASTM C857.
- GRATE SHALL BE WOODARD'S CONCRETE PRODUCTS CAST IRON FRAME AND GRATE MODEL GRATE-30x48 OR APPROVED EQUAL.

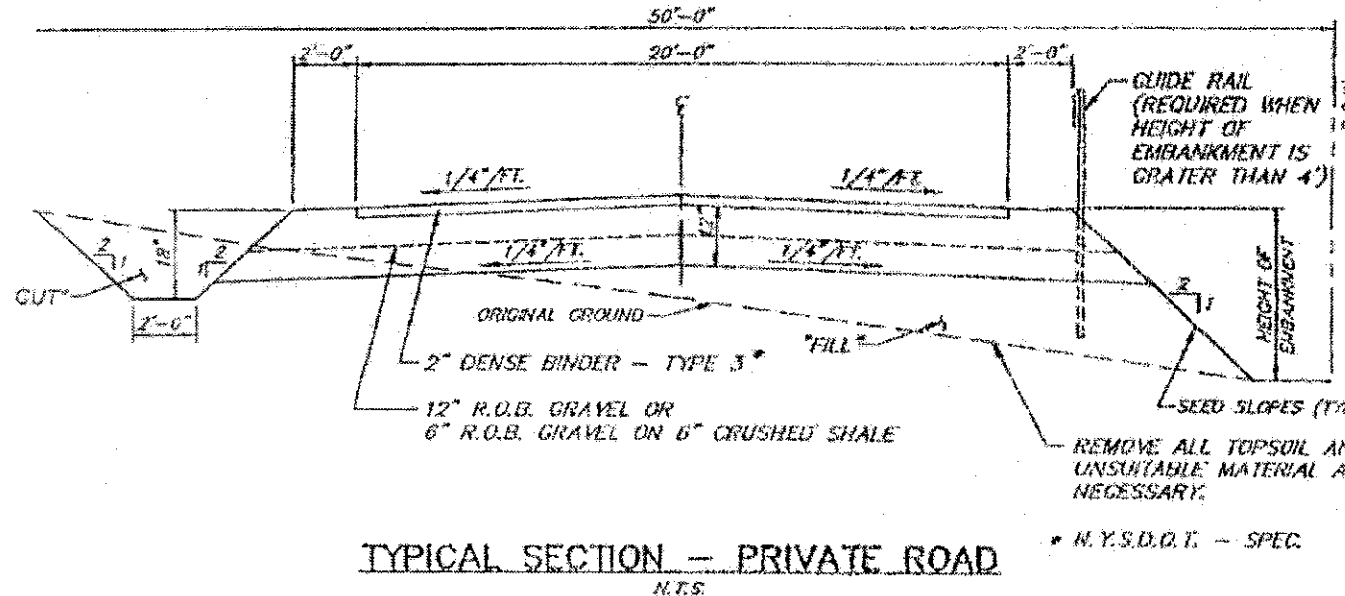

- TYPICAL SECTION - PRIVATE ROAD**
N.T.S.
- THE SUBGRADE SHALL BE MADE STABLE TO THE SATISFACTION OF THE TOWN ENGINEER. ALL TOPSOIL, LOAM, ROCKS AND ORGANIC MATERIAL SHALL BE REMOVED UNTIL A SATISFACTORY SUBGRADE IS ESTABLISHED. FILL SHALL BE MADE IN 12" MAX LAYERS COMPACTED TO MINIMUM 90% STANDARD PROCTOR.
 - THE FOUNDATION COURSE SHALL BE WELL GRADED AND CONTAIN STONES NO LARGER THAN 3 INCHES IN DIMENSION. RUN-OF-BANK (R.O.B.) GRAVEL SHALL BE PLACED IN ONE LAYER AND THOROUGHLY COMPACTED PRIOR TO FINE GRADING.

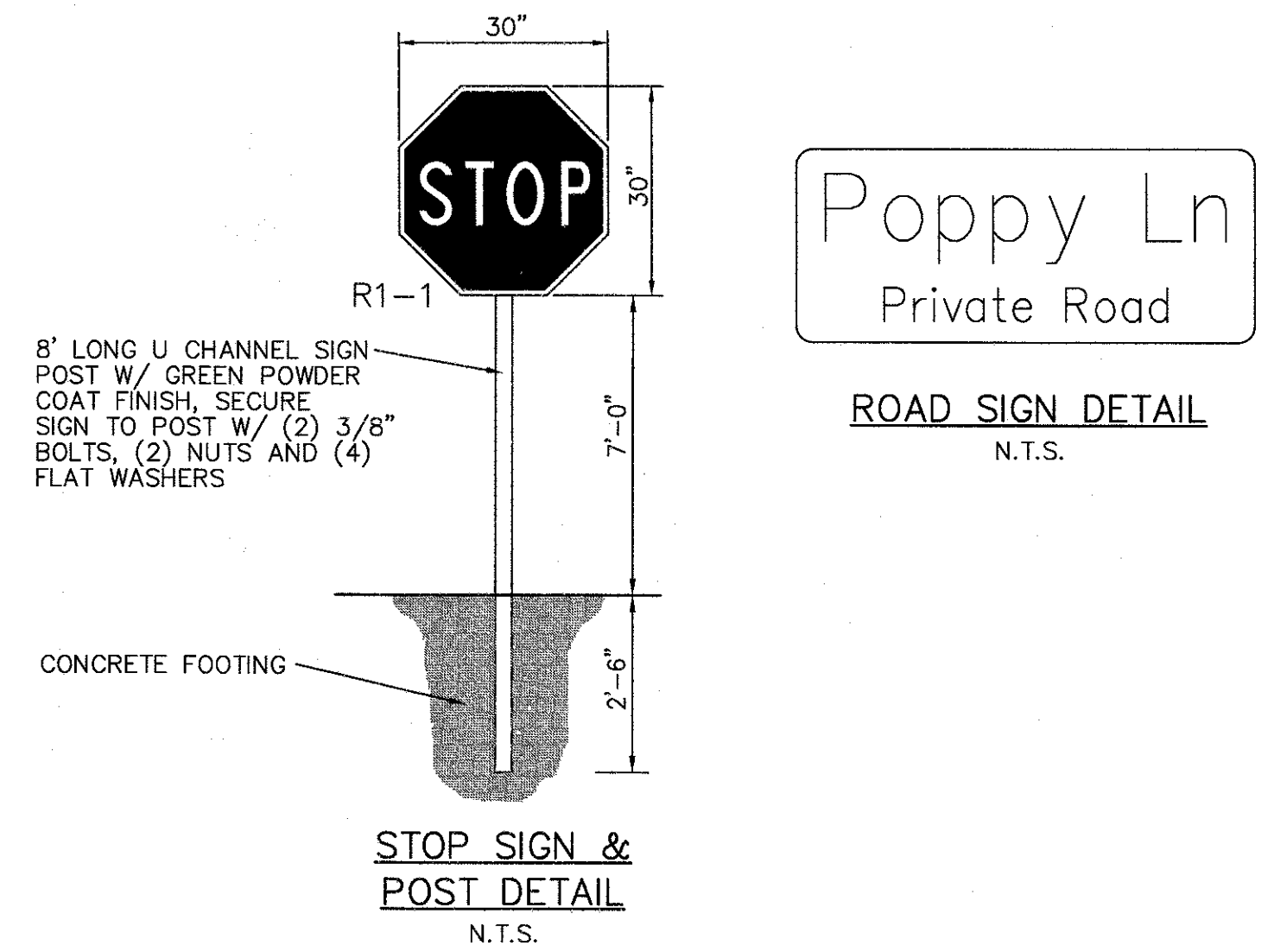

STOP SIGN & POST DETAIL
N.T.S.

SOIL EROSION NOTES

- SILT FENCE BARRIERS SHALL BE INSTALLED PRIOR TO CONSTRUCTION.
- DISTURBANCE TO BE LIMITED TO THE MINIMUM NECESSARY FOR THE GRADING AND CONSTRUCTION OF THE DWELLING, DRIVEWAY, LAWN, UTILITIES, ETC.
- TEMPORARY SEEDING WITH ANNUAL RYE GRASS OR OTHER RAPID GROWING MIXTURE SHALL BE PERFORMED ON DISTURBED SOIL REMAINING VACANT FOR MORE THAN 14 DAYS AS FOLLOWS:
 - SEED WITH ANNUAL RYEGRASS (2.5 LBS. PER 1,000 SQ. FT.)
 - MULCH WITH STRAW (90 LBS. PER 1,000 SQ. FT.)
- ALL DISTURBED AREAS TO BE MULCHED TO PREVENT EROSION, THE CONTRACTOR SHALL COMPLY WITH ALL REQUESTS OF THE VILLAGE ENGINEER OR BUILDING INSPECTOR DURING CONSTRUCTION WITH REGARD TO EROSION CONTROL DEVICES.
- EROSION CONTROL MEASURES SHALL REMAIN IN PLACE AND BE MAINTAINED BY THE CONTRACTOR UNTIL PERMANENT STABILIZATION HAS BEEN ESTABLISHED.
- DISTURBED PORTIONS OF THE SITE WHERE CONSTRUCTION ACTIVITY CEASES SHALL BE STABILIZED WITH PERMANENT SEED NO LATER THAN 14 DAYS AFTER THE LAST CONSTRUCTION ACTIVITY, AS FOLLOWS:
 - LOOSEN SEVERELY COMPACTED AREAS BY DISING TO 12" DEPTH.
 - FERTILIZE AS PER SOIL TEST OR APPLY 5-10-10 FERTILIZER (20 LBS. PER 1,000 SQ. FT.)
 - SEED WITH THE FOLLOWING MIXTURE AT 5 LBS. PER 1,000 SQ. FT.:
 - 50% KENTUCKY BLUEGRASS
 - 25% MANHATTAN RYE GRASS
 - 25% PENNLAWN CREEPING RED FESCUE
 - MULCH WITH SALT HAY OR STRAW (90 LBS. PER 1,000 SQ. FT.)

GRAVEL CONSTRUCTION ENTRANCE BLANKET SPECIFICATIONS:

- STONE SIZE - USE 1"-4" STONE, OR RECLAIMED OR RECYCLED CONCRETE EQUIVALENT.
- LENGTH - AS REQUIRED, BUT NOT LESS THAN 50 FT.
- THICKNESS - NOT LESS THAN SIX (6) INCHES.
- WIDTH - TWELVE (25) FT. MINIMUM, BUT NOT LESS THAN THE FULL WIDTH AT POINTS WHERE INGRESS OR EGRESS OCCURS.
- FILTER CLOTH - WILL BE PLACED OVER THE ENTIRE AREA PRIOR TO PLACING OF STONE.
- SURFACE WATER - ALL SURFACE WATER FLOWING OR DIVERTED TOWARD CONSTRUCTION ENTRANCES SHALL BE PIPED ACROSS THE ENTRANCE, IF PIPING IS IMPRACTICAL, A MOUNTABLE BERM WITH 5:1 SLOPES WILL BE PERMITTED.
- MAINTENANCE - THE ENTRANCE SHALL BE MAINTAINED IN A CONDITION WHICH WILL PREVENT TRACKING OR FLOWING OF SEDIMENT ONTO PUBLIC RIGHT-OF-WAY. THIS MAY REQUIRE PERIODIC TOP DRESSING WITH ADDITIONAL STONE AS CONDITIONS DEMAND AND REPAIR AND/OR CLEAN OUT OF ANY MEASURES USED TO TRAP SEDIMENT. ALL SEDIMENT SPILLED, DROPPED, WASHED OR TRACKED ONTO PUBLIC RIGHT-OF-WAY MUST BE REMOVED IMMEDIATELY.
- WASHING - WHEELS SHALL BE CLEANED TO REMOVE SEDIMENT PRIOR TO ENTRANCE ONTO PUBLIC RIGHT-OF-WAY. WHEN WASHING IS REQUIRED, IT SHALL BE DONE ON AN AREA STABILIZED WITH STONE AND WHICH DRAINS INTO AN APPROVED SEDIMENT TRAPPING DEVICE.
- PERIODIC INSPECTION AND NEEDED MAINTENANCE SHALL BE PROVIDED AFTER EACH RAIN.

CONSTRUCTION ENTRANCE DETAIL
N.T.S.

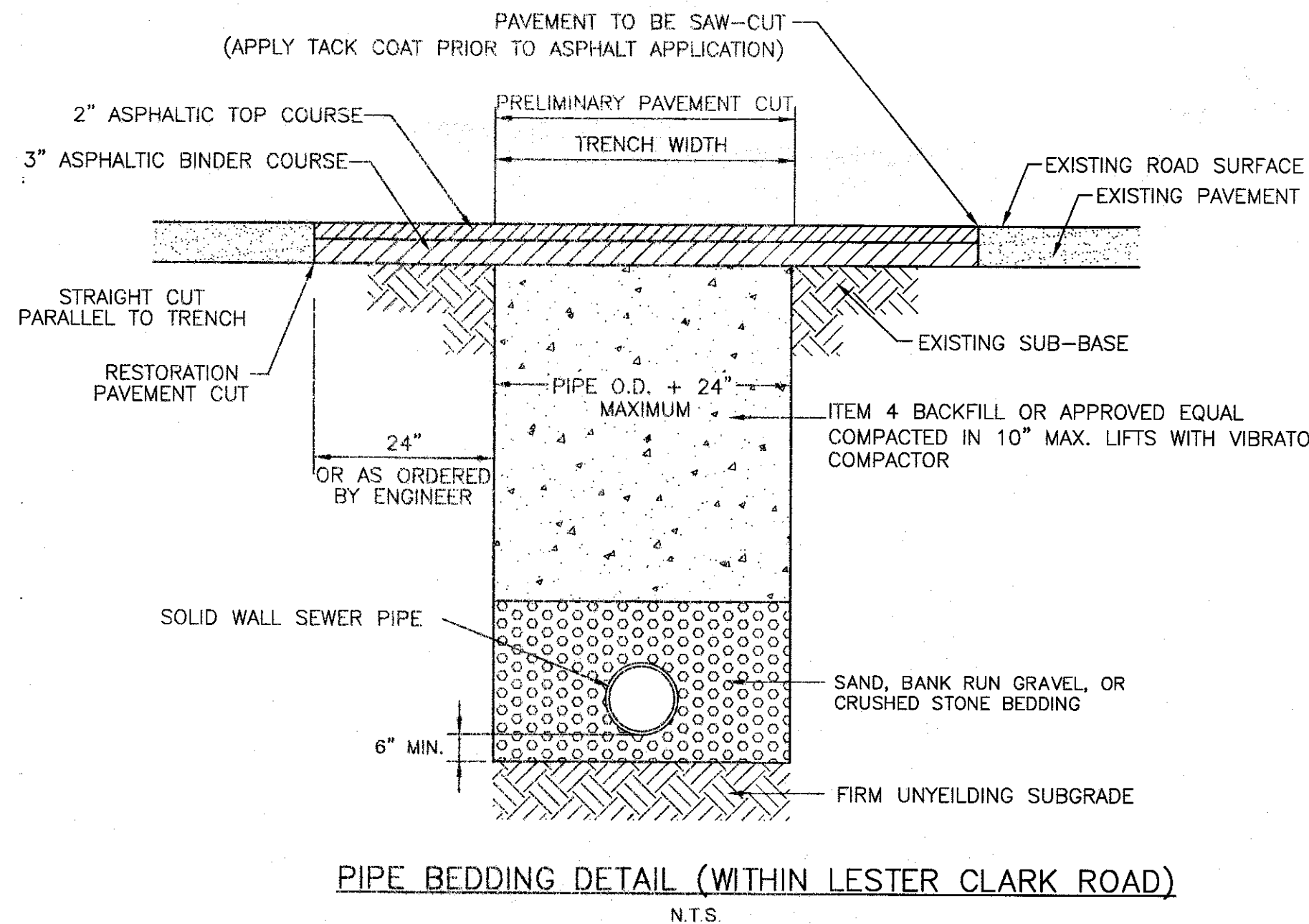
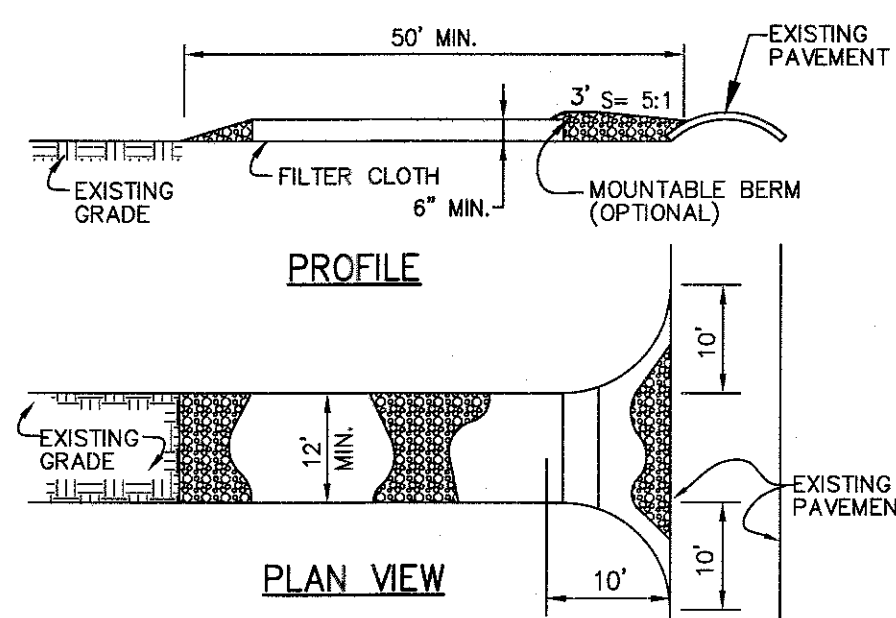

PIPE BEDDING DETAIL (WITHIN LESTER CLARK ROAD)
N.T.S.

PIPE BEDDING DETAIL (ELSEWHERE)
N.T.S.

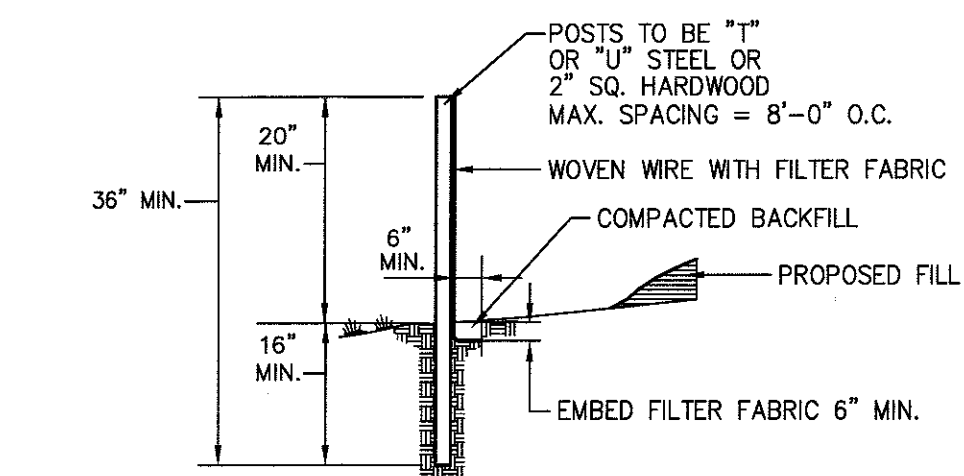

SILT FENCE DETAIL
N.T.S.

- NOTES:
- WHERE TWO SECTIONS OF FILTER CLOTH ADJOIN EACH OTHER, THEY SHALL BE OVERLAPPED BY SIX INCHES AND FOLDED.
 - MAINTENANCE SHALL BE PERFORMED AS NEEDED AND MATERIAL REMOVED WHEN "BULGES" DEVELOP IN THE SILT FENCE.
 - SILT FENCE FABRIC TO BE MIRAFI 100X OR APPROVED EQUAL.
 - WOVEN WIRE FENCE (MIN. 14.5 GAUGE, MAX 6" MESH SPACING)

No.	DATE	DESCRIPTION

DRAWING STATUS		ISSUE DATE:
THIS SHEET IS PART OF THE PLAN SET ISSUED FOR		10/7/21
CONCEPT APPROVAL	N/A OF N/A	SHEET NUMBER
PLANNING BOARD APPROVAL	3 OF 3	
OCDOH REALTY SUBDIVISION APPROVAL	N/A OF N/A	
OCDOH WATERMAIN EXTENSION APPROVAL	N/A OF N/A	
NYSDEC APPROVAL	N/A OF N/A	
NYSDOT APPROVAL	N/A OF N/A	
OTHER	N/A OF N/A	
FOR R/D	N/A OF N/A	
FOR CONSTRUCTION	N/A OF N/A	
THIS PLAN SET HAS BEEN ISSUED SPECIFICALLY FOR THE APPROVAL OR ACTION NOTED ABOVE AND SHALL NOT BE USED FOR ANY OTHER PURPOSE. THIS SHEET SHALL BE CONSIDERED INVALID UNLESS ACCOMPANIED BY ALL SHEETS OF THE DENOTED PLAN SET(S).		

COPIES OF THIS DOCUMENT WITHOUT AN ACTUAL OR FACSIMILE OF THE ENGINEER'S SIGNATURE AND AN ORIGINAL STAMP IN RED OR BLUE INK SHALL BE CONSIDERED INVALID.

UNAUTHORIZED ALTERATIONS OR ADDITIONS TO THIS DOCUMENT BEARING THE SEAL OF A LICENSED PROFESSIONAL ENGINEER IS A VIOLATION OF SECTION 2209 SUBSECTION 2 OF THE NEW YORK STATE EDUCATION LAW.

ROSS WINGLOVITZ, P.E.
NEW YORK LICENSE # 071701

ENGINEERING & SURVEYING PROPERTIES
Achieving Successful Results with Innovative Designs

WARWICK OFFICE
17 RIVER STREET
WARWICK, NY 10990
PH: (845) 986-7737
WWW.EP-PC.COM

CONSTRUCTION DETAILS

POPPY LANE
LESTER CLARK ROAD
TOWN OF NEWBURGH
ORANGE COUNTY, NEW YORK

JOB #: 1493.01 DRAWN BY: DJG
DATE: 10/7/21 SCALE: AS NOTED
REVISION: 0 TAX LOTS: 6-1-113, 114 & 115

C-3

REFERENCES:

- TOWN OF NEWBURGH TAX MAP SECTION 6.
- TOWN OF MARLBOROUGH TAX MAP SECTION 108.003
- DEEDS FILED IN THE ORANGE & ULSTER COUNTY CLERK'S OFFICE AS:

L.2351 P.5	L.14656 P.1460	L.12459 P.1377	L.3542 P.322
L.3673 P.323	L.2695 P.200	L.14499 P.957	L.3713 P.137
L.6191 P.321	L.14332 P.776	L.14325 P.1415	L.3988 P.171
L.1234 P.35	L.5690 P.341	L.12793 P.1499	
- MAP FILED IN THE ORANGE COUNTY CLERK'S OFFICE AS:

FILED MAP #252-05
FILED MAP #8972
FILED MAP #5272
FILED MAP #2000-05
FILED MAP #8866

LEGEND

- DENOTES EXISTING UTILITY POLE
- DENOTES EXISTING OVERHEAD WIRES
- DENOTES WELL (LOCATED OR AS PER PLANS)

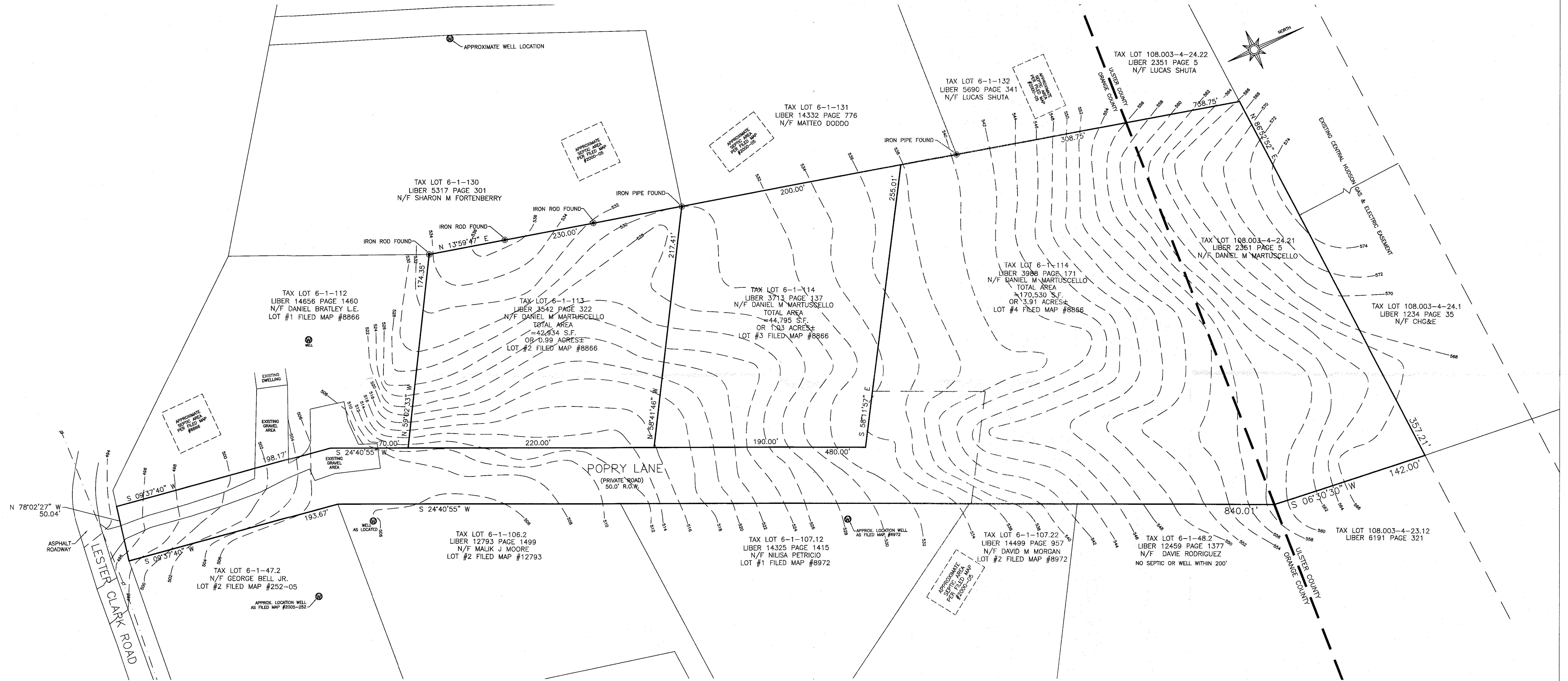

I HEREBY CERTIFY THAT:
 THIS MAP OR PLAT IS BASED UPON THE FIELD NOTES OF THE SURVEY AND OTHER REFERENCES SHOWN.
 ALL RECORDED EASEMENTS OR RIGHTS-OF-WAY AS SHOWN IN THE TITLE REPORT AND OTHER REFERENCES ARE SHOWN.
 ALL OBSERVABLE EVIDENCE OF EASEMENTS ON THE GROUND ARE SHOWN.
 ALL OBSERVABLE, ABOVE GROUND EVIDENCE OF BUILDINGS, STRUCTURES AND OTHER IMPROVEMENTS ARE SHOWN.
 UNAUTHORIZED ALTERATION TO A MAP BEARING A LICENSED PROFESSIONAL LAND SURVEYOR'S SEAL IS A VIOLATION OF SECTION 7209, SUBDIVISION 2, OF THE NEW YORK STATE EDUCATION LAW.
 THIS CERTIFICATION IS NOT AN EXPRESS OR IMPLIED WARRANTY OR GUARANTEE, IT IS PURELY A STATEMENT OF PROFESSIONAL OPINION BASED ON KNOWLEDGE, INFORMATION AND BELIEF, BASED ON EXISTING FIELD EVIDENCE AND DOCUMENTARY EVIDENCE AVAILABLE.
 CERTIFICATIONS ARE NOT TRANSFERABLE TO ADDITIONAL INSTITUTIONS OR SUBSEQUENT OWNERS.
 PLAN PREPARED PURSUANT TO SECTION 7208m OF THE NEW YORK STATE EDUCATION LAW.
 SUBJECT TO THE FINDINGS OF AN UP-TO-DATE TITLE SEARCH.

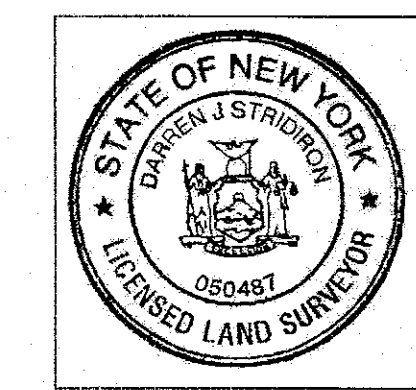

DARREN J. STRIDIRON, P.L.S. NEW YORK STATE LICENSE No. 050487	BOUNDARY & TOPOGRAPHIC SURVEY PREPARED FOR	TAX LOT: AS SHOWN
	LANDS OF MARTUSCELLO	AREA: AS SHOWN
	TOWN OF NEWBURGH ORANGE COUNTY NEW YORK	DATE: 10/12/2020
	CV ASSOCIATES NY, P.E., L.S., P.C. 148 ROUTE 17M SUITE 2, HARRIMAN, NY 10926	SCALE: 1" = 40' JOB NO. 1367-038

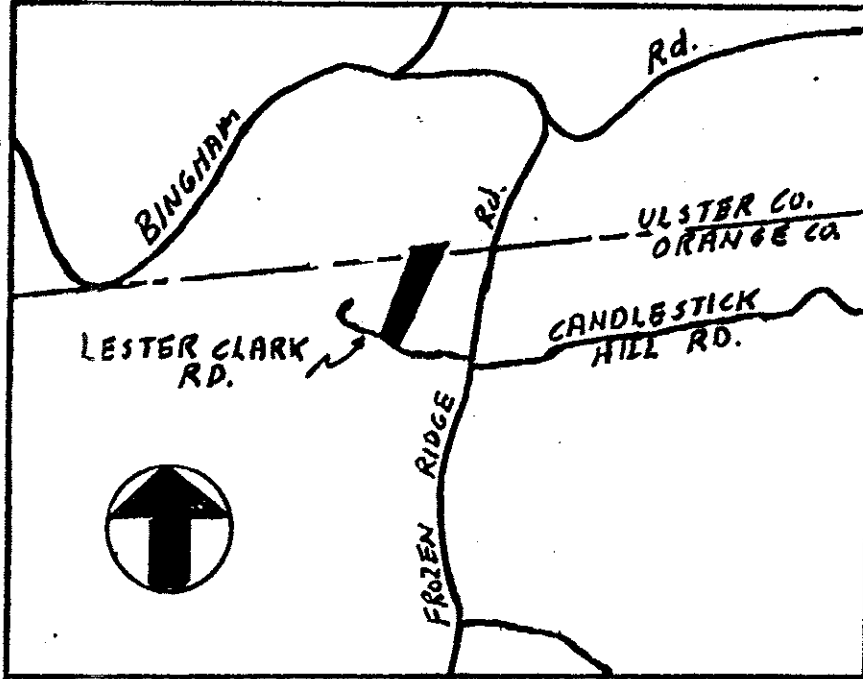

LOCATION MAP
SCALE 1"=2000'

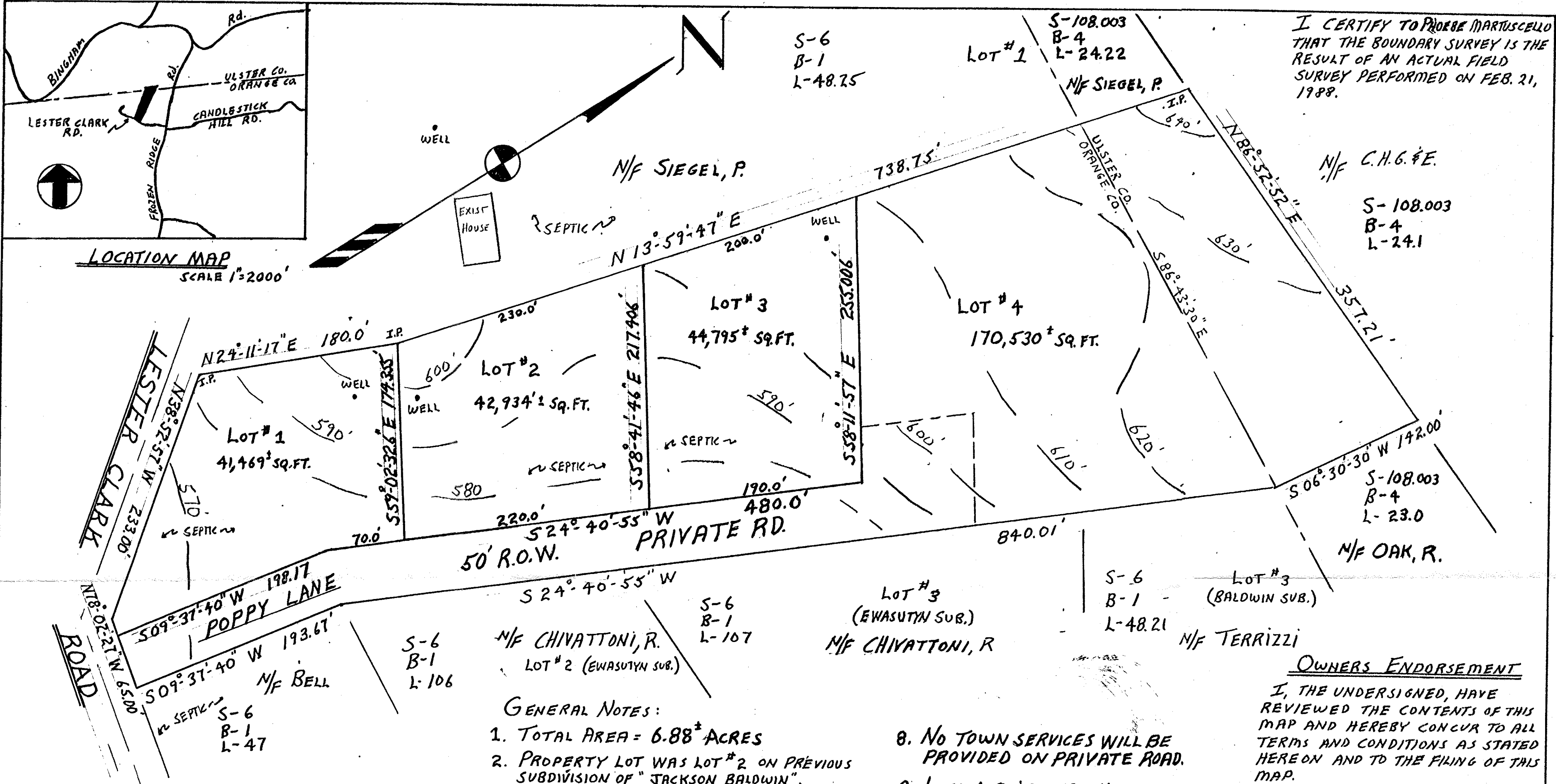

I CERTIFY TO PHOEBE MARTUSCELLO THAT THE BOUNDARY SURVEY IS THE RESULT OF AN ACTUAL FIELD SURVEY PERFORMED ON FEB. 21, 1988.

ZONING - AR

LOT AREA - 40,000 sq. ft.
LOT WIDTH - 150 FT.
LOT DEPTH - 150 FT.
FRONT YARD - 50 FT.
REAR YARD - 40 FT.
ONE SIDE YD. - 30 FT.
BOTH SIDE YDS. - 80 FT.

PROPOSED DATA: LOT #1

LOT AREA - 41,469 sq. ft.
LOT WIDTH - 220 FT.
LOT DEPTH - 170 FT.
FRONT YARD - 50 FT.
REAR YARD - 92 FT.
ONE SIDE YD. - 60 FT.
BOTH SIDE YDS. - 170 FT.

RECORD OWNER

PHOEBE E. MARTUSCELLO
OLD POST ROAD
MARLBORO, NY 12542

SUBDIVIDER

SAME AS RECORD OWNER

By GERALD ZIMMERMAN, P.L.S.
N.Y.S. Lic. # 49410 THIS 28th DAY OF
FEB, 1988.

GENERAL NOTES:

- TOTAL AREA = 6.88[±] ACRES
- PROPERTY LOT WAS LOT #2 ON PREVIOUS SUBDIVISION OF "JACKSON BALDWIN". SUBDIVISION MAP WAS FILED IN THE ORANGE COUNTY CLERKS OFFICE ON 5-30-80 AS MAP # 5272.
- A PLOT PLAN SHOWING THE PROPOSED SEPTIC SYSTEM DESIGN AND WELL LOCATION PREPARED BY A P.E. OR L.S. MUST BE SUBMITTED AND APPROVED BY THE TOWN BUILDING INSPECTOR BEFORE A BUILDING PERMIT CAN BE ISSUED.
- TAX MAP DATA = S-6, B-1, L-48.24
- UTILITY COMPANIES SHALL HAVE THE RIGHT TO INSTALL AND MAINTAIN ALL UTILITIES IN OR OVER THE 50' R.O.W.
- STREET SIGN AND PRIVATE ROAD SIGN MUST BE ERCTED BEFORE A BUILDING PERMIT IS ISSUED, ALONG WITH A STOP SIGN.
- A ROAD MAINTANCE AGREEMENT IS TO BE FILED IN THE ORANGE COUNTY CLERKS OFFICE, AND WITH BUILDING INSPECTOR.

- NO TOWN SERVICES WILL BE PROVIDED ON PRIVATE ROAD.
- LOTS 1, 2, & 3 SHALL HAVE THE RIGHT OF INGRESS AND EGRESS OVER 50 FT. R.O.W. TO LOT #4. SUBJECT TO ROAD MAINTENANCE AGREEMENT.
- ROAD TO BE BUILT BEFORE A C.O. WILL BE ISSUED BY THE BUILDING INSPECTOR.
- SHRUBS TO BE REMOVED ON ROAD FRONT OF LOT #1 TO PROVIDE SITE DISTANCE.

OWNERS ENDORSEMENT

I, THE UNDERSIGNED, HAVE REVIEWED THE CONTENTS OF THIS MAP AND HEREBY CONCUR TO ALL TERMS AND CONDITIONS AS STATED HEREON AND TO THE FILING OF THIS MAP.

Phoebe E. Martuscello

SUBDIVISION APPROVED
PLANNING BOARD, TOWN OF NEWBURGH
ORANGE COUNTY, NEW YORK
DATE: 2-22-88

MINOR SUBDIVISION
LANDS OF
PHOEBE E. MARTUSCELLO
LESTER CLARK ROAD
TOWN OF NEWBURGH
ORANGE Co. - NEW YORK STATE

DATE 2-22-88 SCALE 1"=60'
SHEET 1 OF 2 DRAWING # 38-12-HCT

map # 8866
Filed May 19, 1988
Orange County Clerk
FILED
1988 MAY 18 AM 11:49

#20 - Phoebe Martuscello