

# TOWN OF NEWBURGH

*Crossroads of the Northeast*

ZONING BOARD OF APPEALS  
OLD TOWN HALL  
308 GARDNERTOWN ROAD  
NEWBURGH, NEW YORK 12550

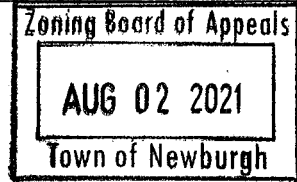

## APPLICATION

OFFICE OF ZONING BOARD  
(845) 566-4901

DATED: April 8, 2021

TO: **THE ZONING BOARD OF APPEALS**  
THE TOWN OF NEWBURGH, NEW YORK 12550

I (WE) Gas Land Petroleum, Inc. PRESENTLY  
RESIDING AT NUMBER 3 Ohioville Road, New Paltz, NY 12561  
TELEPHONE NUMBER 845-331-7545

HEREBY MAKE APPLICATION TO THE ZONING BOARD OF APPEALS FOR THE FOLLOWING:

- \_\_\_\_\_ A USE VARIANCE
- \_\_\_\_\_ AN AREA VARIANCE
- \_\_\_\_\_ INTERPRETATION OF THE ORDINANCE
- \_\_\_\_\_ SPECIAL PERMIT

1. LOCATION OF THE PROPERTY:

43-5-1 (TAX MAP DESIGNATION)  
5200 Route 9W (STREET ADDRESS)  
B, LHI Overlay and R3 Districts (ZONING DISTRICT)

2. PROVISION OF THE ZONING LAW APPLICABLE, (INDICATE THE SECTION AND SUBSECTION OF THE ZONING LAW APPLICABLE BY NUMBER; DO NOT QUOTE THE LAW).

- 1) 185-15(B) - accessory structure closer to fronting street than main structure;
- 2) 185-28(G) - 1,000-foot setback from Stewarts to convenience store with gasoline filling station;
- 3) 185-28(G) - 1,000-foot setback from Stewarts to motor vehicle service station;
- 4) 185-28(G) - 1,000-foot setback from convenience store with gasoline filling station to motor vehicle service station;
- 5) 185-15(A)1 - building height - accessory building;
- 6) 185-15(A)3 - maximum coverage in yard - accessory building; and
- 7) 185-11 - minimum side yard - accessory building

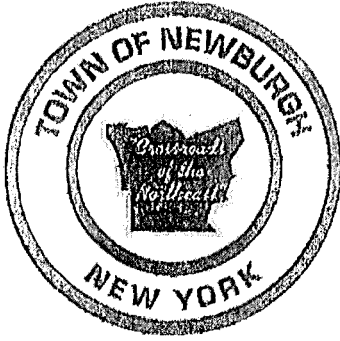

# TOWN OF NEWBURGH

*Crossroads of the Northeast*

ZONING BOARD OF APPEALS  
OLD TOWN HALL  
308 GARDNERTOWN ROAD  
NEWBURGH, NEW YORK 12550

### 3. IF VARIANCE TO THE ZONING LAW IS REQUESTED:

- a) APPEAL IS MADE FROM DISAPPROVAL BY THE TOWN BUILDING INSPECTOR OR BUILDING PERMIT APPLICATION. SEE ACCOMPANYING NOTICE DATED: \_\_\_\_\_
- b) OR DENIAL (REFERRAL) BY THE PLANNING BOARD OF THE TOWN OF NEWBURGH OF AN APPLICATION TO THE BOARD, SEE ACCOMPANYING NOTICE DATED: March 25, 2021 ZBA Re-referral Planning Board Project No: 2019-16

### 4. DESCRIPTION OF VARIANCE SOUGHT:

1) 185-15(B) - accessory structure closer to fronting street than main structure; 2) 185-28(G) - 1,000-foot setback from Stewarts to convenience store with gasoline filling station; 3) 185-28(G) - 1,000-foot setback from Stewarts to motor vehicle service station; 4) 185-28(G) - 1,000-foot setback from convenience store with gasoline filling station to motor vehicle service station; 5) 185-15(A)1 - building height - accessory building; 6) 185-15(A)3 - maximum coverage in yard - accessory building; and 7) 185-11 - minimum side yard - accessory building

### 5. IF A USE VARIANCE IS REQUESTED: STRICT APPLICATION OF THE ZONING LAW WOULD PRODUCE UNNECESSARY HARDSHIP IN THAT:

- a) UNDER APPLICABLE ZONING REGULATIONS THE APPLICANT IS DEPRIVED OF ALL ECONOMIC USE OR BENEFIT FROM THE PROPERTY IN QUESTION BECAUSE:  
Not Applicable.

**(ATTACH WITH THIS APPLICATION COMPETENT FINANCIAL EVIDENCE ESTABLISHING SUCH DEPRIVATION)**

- b) THE HARDSHIP IS UNIQUE AND DOES NOT APPLY TO A SUBSTANTIAL PORTION OF THE DISTRICT OR NEIGHBORHOOD BECAUSE:  
Not Applicable.

- c) THE VARIANCE WOULD NOT ALTER THE ESSENTIAL CHARACTER OF THE NEIGHBORHOOD BECAUSE:  
Not Applicable.

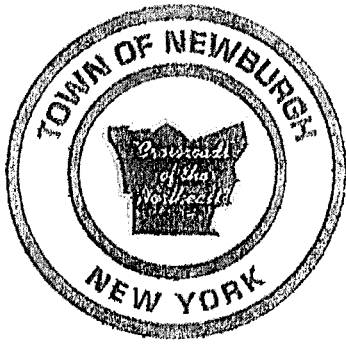

# TOWN OF NEWBURGH

*Crossroads of the Northeast*

ZONING BOARD OF APPEALS  
OLD TOWN HALL  
308 GARDNERTOWN ROAD  
NEWBURGH, NEW YORK 12550

- d) THE HARDSHIP HAS NOT BEEN SELF-CREATED BECAUSE:  
Not Applicable.

## 6. IF AN AREA VARIANCE IS REQUESTED:

- a) THE VARIANCE WILL NOT PRODUCE AN UNDESIRABLE CHANGE IN THE CHARACTER OF THE NEIGHBORHOOD OR A DETRIMENT TO NEARBY PROPERTIES BECAUSE:

The project site already contains commercial uses which include an office, a diesel fueling station and a towing business with auto repair/auto body facility. The project is located along Route 9W and will improve the appearance of the site with new landscaping, elimination of towing operations, and an architecturally pleasing building which is appropriately scaled and well designed, and which screens the view of the existing auto repair/auto body facility located to the rear of the site. In addition, site accesses will be reduced from three to one and street trees and a sidewalk will be added along Route 9W. As described, no undesirable change or detrimental effect to nearby properties will be created by granting the area variance.

- b) THE BENEFIT SOUGHT BY THE APPLICANT CAN NOT BE ACHIEVED BY SOME METHOD, FEASIBLE FOR THE APPLICANT TO PURSUE, OTHER THAN AN AREA VARIANCE, BECAUSE:

The project site is constrained by residential zoned area, which does not allow motor vehicle service centers. The site is currently developed with an office, diesel fueling station, Pat's Towing facility and residential uses. The site plan arranges the new motor vehicle service station away from the current residential uses resulting in an encroachment within the 1,000 foot setback. The encroachment into the side yard and exceedance over maximum height and coverage is pre-existing non-complying and would be required under any site plan approval process. Similarly, the encroachment of the auto repair/auto body facility (towing operations to be eliminated) into the 1,000 foot setback is pre-existing non-complying and would be required under any site plan approval process if the facility remain. Accordingly, these benefits cannot be achieved by other feasible methods.

- c) THE REQUESTED AREA VARIANCE IS NOT SUBSTANTIAL BECAUSE:

With the exception of one requested variance, each variance requires less than a 50% increase in the non-compliance. The requested variance for encroachment into the 1,000 required setback between the proposed motor vehicle service station and auto repair/auto body facility to remain may be considered substantial, but remains the most feasible alternative. There is no change in the character of the neighborhood as the proposed fueling station is a modernization of the existing fueling operations that already exist on the property and located within 1,000-feet to the Stewart's operation.

- d) THE PROPOSED VARIANCE WILL NOT HAVE AN ADVERSE EFFECT OR

The July 26, 2021 Full Environmental Assessment Form, Part 1 and narrative report assessed the potential for significantly adverse physical or environmental impacts from the proposed project. The proposed project is not anticipated to result in significantly adverse impacts to the resource areas/conditions noted above. In fact, as explained above, the project will result in improvements to the site including, an aesthetically pleasing building replacing a large expanse of asphalt, eliminating towing operations, improved traffic safety and circulation through the reduction of access points to the site, and the addition of landscaping for screening at Route 9W and to screen the existing auto repair/auto body facility to remain.

- e) THE HARDSHIP HAS NOT BEEN SELF-CREATED BECAUSE:

The Applicant desires to develop a motor vehicle service station which will dispense fuel in a location that currently dispenses fuel and has developed a design for Lot 1 that supports the functionalities needed to support this use despite the constraints of the pre-existing uses and the split zoned parcel. The proposed development will result in improved conditions at the site, including lining Route 9W with trees, eliminating on site towing operations, providing a sidewalk, replacing asphalt with an architecturally pleasing building and introducing landscaping within the site. For the reasons noted above, the Applicant does not believe that the alleged difficulty is self created.



# TOWN OF NEWBURGH

*Crossroads of the Northeast*

ZONING BOARD OF APPEALS  
OLD TOWN HALL  
308 GARDNERTOWN ROAD  
NEWBURGH, NEW YORK 12550

OFFICE OF ZONING BOARD  
(845) 566-4901

7. ADDITIONAL REASONS (IF PERTINENT):

\_\_\_\_\_  
\_\_\_\_\_  
\_\_\_\_\_

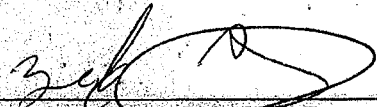
  
\_\_\_\_\_  
PETITIONER(S) SIGNATURE

Gas Land Petroleum, Inc.  
Zeidan Nesheiwat, Vice President, contract vendee for proposed Lot 1

STATE OF NEW YORK; COUNTY OF ORANGE: *Dutchess*

SWORN TO THIS 14 DAY OF May 20 2020

STEVEN F. NESHEIWAT  
NOTARY PUBLIC-STATE OF NEW YORK  
No. 02NE6137919  
Qualified in Dutchess County  
My Commission Expires 8/1/22

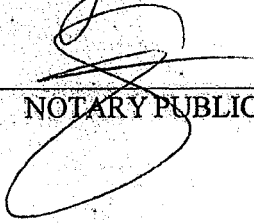
  
\_\_\_\_\_  
NOTARY PUBLIC

NOTE: NYS GML Section 239-m (3) for proposed actions that are within 500 feet of the properties or thresholds listed in the statute the Zoning Board of Appeals is required to send a copy of the complete application to the Orange County Department of Planning to be reviewed prior to Zoning Board of Appeals decision. And also NYS GML Section 239-NN requires notification for any proposed actions, to the Municipal Clerk, within 500 feet of the Border of that adjoining County, Town or City.  
**(ALL MATERIALS REGARDING THE APPLICATION MUST BE SUBMITTED TO THE ZONING BOARD OFFICE FOR REVIEW NO LATER THAN 10 DAYS PRIOR TO THE HEARING DATE OR THEY MAY NOT BE CONSIDERED THE NIGHT OF THE MEETING).**

(NOTE: BOARD MEMBERS MAKE SITE VISITS TO ALL THE PROPERTIES)

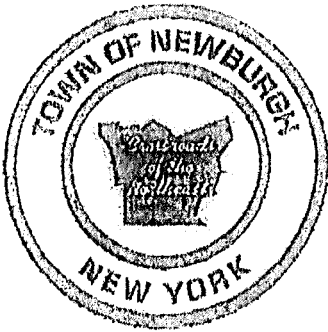

# TOWN OF NEWBURGH

*Crossroads of the Northeast*

ZONING BOARD OF APPEALS  
OLD TOWN HALL  
308 GARDNERTOWN ROAD  
NEWBURGH, NEW YORK 12550

## PROXY

P&J Property Walnut St LLC, DEPOSES AND SAYS THAT

HE/SHE RESIDES AT 24 Walnut Street, New Windsor, NY 12553

IN THE COUNTY OF Orange County AND STATE OF New York

AND THAT HE/SHE IS THE OWNER IN FEE OF \_\_\_\_\_

5200 Route 9W, Newburgh, NY 12550 (4.518 acre parcel identified as Tax Parcel 43-5-1)

WHICH IS THE PREMISES DESCRIBED IN THE FOREGOING APPLICA-

TION AND THAT HE/SHE HAS AUTHORIZED Gas Land Petroleum, Inc. and/or

The Chazen Companies

TO MAKE THE FOREGOING APPLICATION AS DESCRIBED THEREIN.

DATED: 2-5-21

Mr. Patrick Macioce, P& J Property Walnut St. LLC  
OWNER'S SIGNATURE

WITNESS' SIGNATURE

STATE OF NEW YORK: COUNTY OF ORANGE:

SWORN TO THIS 5<sup>th</sup> DAY OF February 20 21

NOTARY PUBLIC

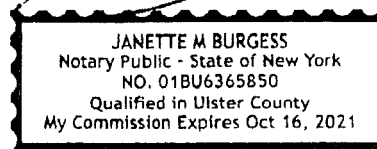

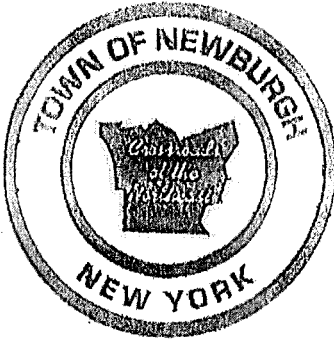

# TOWN OF NEWBURGH

*Crossroads of the Northeast*

ZONING BOARD OF APPEALS  
OLD TOWN HALL  
308 GARDNERTOWN ROAD  
NEWBURGH, NEW YORK 12550

OFFICE OF ZONING BOARD  
(845) 566-4901

**ENCLOSURES: SUBMIT ALL ITEMS TOGETHER**

- \* RECEIPT(S) ISSUED BY THE TOWN CLERK  
(SEE 1-1-2017 FEE SCHEDULE) (X )
- BUILDING INSPECTOR'S DISAPPROVAL (X )  
OR REFERRAL LETTER FROM PLANNING BOARD
- PLOT PLAN, ELEVEN (11) COPIES DRAWN  
TO SCALE (X )
- \* DEED OR CERTIFIED COPY THEREOF (X,)see attached email  
authorizing copy.
- \* ASSESSOR'S LIST OF PROPERTY OWNERS  
WITHIN 500 FEET OF PROPERTY (X )
- FOUR PHOTOGRAPHS TAKEN AT DIFFERENT  
ANGLES (X )
- \* ZONING BOARD APPLICATION WITH FULL  
ENVIRONMENTAL ASSESSMENT FORM (X )
- \* PROXY OR STATEMENT FOR REPRESENTATION  
THEREOF (X )
- SEPTIC DESIGN BY P.E. (IF APPLICABLE) ( )
- PERCULATION TEST (IF APPLICABLE) ( )

**\* ORIGINALS ARE REQUIRED.**

NOTE: NYS GML Section 239-m (3) for proposed actions that are within 500 feet of the properties or thresholds listed in the statute the Zoning Board of Appeals is required to send a copy of the complete application to the Orange County Department of Planning to be reviewed prior to Zoning Board of Appeals decision. And also NYS GML Section 239-NN requires notification for any proposed actions, to the Municipal Clerk, within 500 feet of the Border of that adjoining County, Town or City.

**(ALL MATERIALS REGARDING THE APPLICATION MUST BE SUBMITTED TO THE ZONING BOARD OFFICE FOR REVIEW NO LATER THAN 10 DAYS PRIOR TO THE HEARING DATE OR THEY MAY NOT BE CONSIDERED THE NIGHT OF THE MEETING).**



ORANGE COUNTY – STATE OF NEW YORK  
 ANN G. RABBITT, COUNTY CLERK  
 255 MAIN STREET  
 GOSHEN, NEW YORK 10924

COUNTY CLERK'S RECORDING PAGE  
 \*\*\*THIS PAGE IS PART OF THE DOCUMENT – DO NOT DETACH\*\*\*



BOOK/PAGE: 14001 / 209  
 INSTRUMENT #: 20160005970

Receipt#: 2072152  
 Clerk: KP  
 Rec Date: 01/29/2016 12:55:17 PM  
 Doc Grp: D  
 Descrip: DEED  
 Num Pgs: 4  
 Rec'd Frm: J T ABSTRACT

Party1: COLANDREA RONALD  
 Party2: P&J PROPERTY WALNUT ST LLC  
 Town: NEWBURGH (TN)  
 43-5-1

Recording:  
 Recording Fee 40.00  
 Cultural Ed 14.25  
 Records Management - Coun 1.00  
 Records Management - Stat 4.75  
 TP584 5.00  
 RP5217 All others - State 241.00  
 RP5217 - County 9.00  
 Sub Total: 315.00

Transfer Tax  
 Transfer Tax - State 3800.00  
 Sub Total: 3800.00

Total: 4115.00  
 \*\*\*\* NOTICE: THIS IS NOT A BILL \*\*\*\*

\*\*\*\*\* Transfer Tax \*\*\*\*\*  
 Transfer Tax #: 4650  
 Commercial Transfer Tax  
 Consideration: 950000.00  
 Transfer Tax - State 3800.00  
 Total: 3800.00

Payment Type: Check \_\_\_  
 Cash \_\_\_  
 Charge \_\_\_  
 No Fee \_\_\_

Comment: \_\_\_\_\_

Ann G. Rabbitt  
 Orange County Clerk

Record and Return To:

J T ABSTRACT  
 717 BROADWAY  
 NEWBURGH, NY 12550

Standard N.Y.B.T.U. Form 8007

Bargain & sale deed, with covenant against grantor's acts - Ind. or Corp.

CONSULT YOUR LAWYER BEFORE SIGNING THIS INSTRUMENT-THIS  
INSTRUMENT SHOULD BE USED BY LAWYERS ONLY

THIS INDENTURE, made the 31<sup>st</sup> day of December, Two Thousand Fifteen

**BETWEEN**

RONALD L. COLANDREA, residing at 4 Rivers Edge, Newburgh, NY 12550

party of the first part, and

PqJ

~~BY~~ PROPERTY WALNUT ST LLC, a domestic limited liability company,  
having offices at 24 Walnut Street, New Windsor, NY 12553

party of the second part,

**WITNESSETH**, that the party of the first part, in consideration of TEN and 00/100 (\$10.00) dollars,

lawful money of the United States, and other good and valuable consideration paid by the party of the second part, does hereby grant and release unto the party of the second part, the heirs or successors and assigns of the party of the second part forever,

**ALL** that certain plot, piece or parcel of land, with the buildings and improvements thereon erected, situate, lying and being in the Town of Newburgh, County of Orange and State of New York, being more particularly bounded and described in Schedule "A" annexed hereto and made a part hereof.

**BEING** the same premises described in a certain deed dated December 20, 2008 made by Bernice J. Colandrea as Executrix of the Estate of Louis W. Colandrea, and recorded in the Orange County Clerk's office on February 19, 2009 in Liber 12783 of Deeds at Page 711; and

**ALSO BEING** the same premises described in a certain deed dated May 10, 2012 made by Bernice J. Colandrea, and recorded in the Orange County Clerk's office on July 11, 2012 in Liber 13370 of Deeds at Page 1771.

**TOGETHER** with all right, title and interest, if any, of the party of the first part in and to any streets and roads abutting the above described premises to the center lines thereof,

**TOGETHER** with the appurtenances and all the estate and rights of the party of the first part in and to said premises,

**TO HAVE AND TO HOLD** the premises herein granted unto the party of the second part, the heirs or successors and assigns of the party of the second part forever.

**AND** the party of the first part covenants that the party of the first part has not done or suffered anything whereby the said premises have been incumbered in any way whatever, except as aforesaid.

**AND** the party of the first part, in compliance with Section 13 of the Lien Law, covenants that the party of the first part will receive the consideration for this conveyance and will hold the right to receive such consideration as a trust fund to be applied first for the purpose of paying the cost of the improvement and

Section 43, Block 5, Lot 1



## Schedule A Description

Title Number **JT-WC1850**

Page 1

ALL that certain plot, piece or parcel of land situate lying and being in the Town of Newburgh, Orange County, New York and more particularly bounded and described as follows:

BEGINNING at a point in the east line of State Highway Route 9W in the northerly line of lands now or formerly of Paul Remer and runs thence along said State Highway, North 17-04 East 55.70 feet to a concrete monument;

THENCE North 26-06-30 East 364.34 feet to a point in the southerly line of lands now or formerly of Joseph Rhoda;

THENCE leaving said highway line and along the line of lands of Rhoda, South 63-14 East 545.9 feet to an iron pipe at the end of a stone wall in the westerly line of the Old Marlboro Road;

THENCE along said road, South 33-20-40 West 227.20 feet;

THENCE still along said road, South 32-11 West 94.47 feet to the northeasterly corner of a lot conveyed to Stevens in October 1954 as recorded in the Orange County Clerk's Office in Liber 1325 of Deeds at page 424;

THENCE along Steven's lot, North 61-44 West 198.82 feet to the northwest corner of said Steven's lot;

THENCE along the westerly line of said Steven's lot South 32-53 West 15.46 feet to a point in the line of lands of Remer as aforesaid;

THENCE along said Remer's land, North 61-12 West 129.60 feet to a point marked by a post;

THENCE North 64-50 West 157.90 feet to the point or place of beginning.

FOR INFORMATION ONLY: BEING the same premises conveyed to Ronald L. Colandrea by

> Deed dated December 20, 2008 made by Bernice J. Colandrea as Executrix of the Estate of Louis W. Colandrea, recorded in the Orange County Clerk's Office on February 19, 2009 in Liber 12783 page 711; and

> Deed dated May 10, 2012 made by Bernice J. Colandrea, recorded in the Orange County Clerk's Office on July 11, 2012 in Liber 13370 page 1771.

will apply the same first to the payment of the cost of the improvement before using any part of the total of the same for any other purpose.

The word "party" shall be construed as if it read "parties" whenever the sense of this indenture so requires.

**IN WITNESS WHEREOF**, the party of the first part has duly executed this deed the day and year first above written.

IN PRESENCE OF:

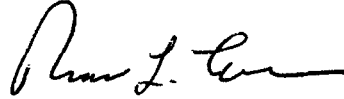

RONALD L. COLANDREA

STATE OF NEW YORK    )  
  ss.:  
COUNTY OF ORANGE    )

On the 31 day of December, 2015, before me, the undersigned, a Notary Public in and for the State of New York, personally appeared Ronald L. Colandrea, known to me or proved to me on the basis of satisfactory evidence to be the individual whose name is subscribed to the within instrument and acknowledged to me that said individual executed the same in his capacity and that by his signature on the instrument, the individual, or the person upon behalf of which the individual acted, executed the instrument

**TODD A. KELSON**  
Notary Public, State of New York  
Qualified in Orange County  
No. 4870143  
Commission Expires August 11, 192018

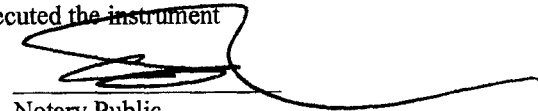

Notary Public  
Commission Expires:

Bargain and Sale Deed  
WITH COVENANT AGAINST GRANTOR'S ACTS  
Title No.

\_\_\_\_\_  
RONALD L. COLANDREA

SECTION 43  
BLOCK 5  
LOT 1  
COUNTY OF ORANGE  
TOWN OF NEWBURGH

RETURN BY MAIL TO:

TO  
P&J PROPERTY WALNUT ST LLC

**J T Abstract Co Inc**  
717 Broadway  
Newburgh New York 12550  
845-562-8855 fax 845-562-0056  
JTAbstract@verizon.net

WC1850

James R. Loeb  
Richard J. Drake, *retired*  
Glen L. Heller\*  
Marianna R. Kennedy  
Gary J. Gogerty  
Stephen J. Gaba  
Adam L. Rodd  
Dominic Cordisco  
Ralph L. Puglielle, Jr.  
Nicholas A. Pascale

Alana R. Bartley  
Aaron C. Fitch  
Judith A. Waye  
Michael Martens

Jennifer L. Schneider  
Managing Attorney

\*L.L.M. in Taxation

May 8, 2020

BY EMAIL ONLY

Darrin J. Scalzo, Chairman  
Zoning Board of Appeals  
Town of Newburgh  
Town Hall  
1496 Route 300  
Newburgh, New York 12550

Re: Gas Land / 5200 Route 9W; Planning Board Project No. 19-16

Dear Chairman Scalzo and Board Members:

At the Planning Board's May 7, 2020 meeting, the Planning Board resolved to refer this application to the Zoning Board of Appeals for its consideration of the following area variances that are required for this project.

Gas Land Petroleum, Inc. (the Applicant) proposes a two-lot subdivision of a 4.518-acre parcel located at 5200 NYS Route 9W, to create two lots of 1.088 acres (proposed Lot 1) and 3.429 acres (proposed Lot 2). The site is currently improved with a diesel fueling station, small office building, a towing business with repair shop, a single family home, and an accessory barn with a one-bedroom apartment. The Applicant also seeks site plan approval to construct a 2,772 square foot convenience store with six fuel pumps and associated parking on proposed Lot 1. The existing office building will be removed. The towing business, the single-family home and the barn with apartment will remain on proposed Lot 2.

The project requires the following variances from the Zoning Board of Appeals: (1) relief from the 1000 foot requirement to the nearest motor vehicle service station (Town Zoning Code § 158-28(G) due to the proposed convenience store's proximity to Stewart's (+/- 900 feet); and (2) likewise, the convenience store will be adjacent and on a separate lot to the towing business, and will require a variance from § 158-28(G).

Furthermore or the existing accessory barn with apartment on proposed Lot 2, will require the following variances: (1) the accessory structure is located closer to the fronting street than the main structure on the lot, which requires a variance from § 185-15(B); (2) a side yard setback variance given that 15 feet is required, and 10.8 feet is provided; (3) a variance for the building's height, as a maximum of 15 feet is allowed and the building consists of 2 stories; and (4) a variance for the maximum percentage in yard area, where 10% is allowed, and 12% is proposed.

The Planning Board has not declared its intent to serve as lead agency so that the Zoning Board of Appeals may consider and process this application without the need to wait for the Planning Board to conclude its review.

Thank you for your consideration of this matter.

Very Truly Yours

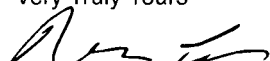
  
Dominic Cordisco

cc:

David A. Donovan, Esq., Attorney for the ZBA  
Town of Newburgh Planning Board  
Patrick J. Hines, Planning Board Consulting Engineer



**ADDENDUM TO ZBA APPLICATION FOR AREA VARIANCE  
REASONS FOR APPEAL  
Proposed Convenience Store with Fuel Pumps  
5200 Route 9W, Newburgh, NY**

Gas Land Petroleum, Inc., (the Applicant) is under contract to purchase a 4.518-acre parcel located at 5200 NYS Route 9W in the Town of Newburgh. The parcel is identified as Section 43, Block 5, Lot 1 on the Town of Newburgh tax map and is owned by P&J Property Walnut St LLC. The site currently contains a diesel fueling station, small office building, a towing business with repair shop for its commercial vehicles, a single-family home, and an accessory barn with a one-bedroom apartment. The Applicant is proposing the construction of a 2, 940 square foot (SF) convenience store with six fuel pumps (12 fueling positions), two diesel pumps (4 fueling positions) for tractor trailers, and associated parking. The existing office building will be removed and the fueling operations will continue with the addition of gasoline. The towing business will be abandoned, and the use will be converted to an auto repair facility. The single- family residence will be removed. The barn with apartment will remain. All existing car storage on the front of the site will be removed. The 4.518-acre parcel has frontage along NYS Route 9W along the western property line and Albany Post Road along the eastern property line. Several access drives exist along NYS Route 9W.

***Required Area Variances***

- 1) 185-15(B) - accessory structure closer to fronting street than main structure;
- 2) 185-28(G) - 1,000-foot setback from Stewarts to convenience store with gasoline filling station;
- 3) 185-28(G) - 1,000-foot setback from Stewarts to motor vehicle service station;
- 4) 185-28(G) - 1,000-foot setback from convenience store with gasoline filling station to motor vehicle service station;
- 5) 185-15(A)1 - building height - accessory building; and
- 6) 185-15(A)3 - maximum coverage in yard - accessory building

Table 1 presents the requested variances.

**Table 1: Business (B) Zoning District /  
 Light and Heavy Industrial Equipment and Recreational Vehicle Sales, Service and Repair (LHI)  
 Overlay District  
 Requested Variances**

	<b>Requirement</b>		<b>Proposed</b>	<b>Requested Variance</b>	<b>Percent Meeting Requirement</b>	<b>Percent Requested Variance</b>
1	Accessory Building - Distance from 9W	142.3 feet	119.6 feet	22.7 feet	84%	16%
2	Minimum Separation from Proposed New Gasoline Filling Station to Stewarts (5223 West Street)	1,000 feet	900 feet	100 feet	90%	10%
3	Minimum Separation from existing Motor Vehicle Service Station to Stewarts (5223 West Street)	1,000 feet	950 feet	50 feet	95%	5%
4	Minimum Separation from existing Motor Vehicle Service Station to Proposed New Gasoline Filling Station	1,000 feet	107 feet	893 feet	11%	89%
5	Maximum Building Height	15 feet	20 feet	5 feet	N/A	33%
6	Maximum Coverage in Required Yard Area	10%	12%	2%	N/A	20%
7	Accessory Building – Minimum Side Yard Setback	15 feet	9 feet	6 feet	60%	40%

**Area Variance Criteria**

Per Section 185-54B, in making its determination, the Zoning Board of Appeals shall take into consideration the following:

(1) To authorize, upon appeal of a decision of the Building and Code Enforcement Officer and the Chairman of the Planning Board, such variances from the terms of this chapter as will not be contrary to the public interest where, owing to exceptional and extraordinary circumstances, there are unnecessary hardships or practical difficulties in the way of carrying out of the strict letter of this chapter, subject to terms and conditions to be fixed by the Zoning Board of Appeals; provided, however, that no such variance shall be granted unless the Zoning Board of Appeals finds:

(a) That there are special circumstances or conditions fully described in the findings of the Board applying to the land or building for which the variance is sought, which circumstances or conditions are unique to such land or building and do not apply generally to land or buildings in the neighborhood and have not resulted from any act of the appellant or applicant subsequent to the adoption of this chapter, whether in violation of the provisions hereof or not.

The site is currently occupied by an active towing and repair business, and diesel fueling facility, which has been operational since at least 1995. The existing tax parcel is unique as it is split between two zoning districts, Business and R-3 Residential Zoning Districts. Currently, the residential zoned portion of the property is not developed. In the proposed condition, the parcel will remain developed within the Business/LHI Zone portion of the lot areas only.

The site is located partially within the B and LHI Overlay Districts, which permits motor vehicle service stations and light and heavy industrial equipment, service and repair by site plan approval of the Planning Board. The proposed project to allow for the development of a modernized motor vehicle service station is consistent with the intent of the existing zoning and will be consistent with area land uses.

The project is consistent with the recommendations of the Comprehensive Plan Update in that it is located just north of the Hamlet of Balmville and will serve the neighboring residents and businesses while also taking advantage of tourist traffic through the area. In March 2004, and the Comprehensive Plan Update recommended study of the Route 9W corridor to evaluate potential improvements and provide direction for future land use patterns. The proposed project will improve Route 9W safety and circulation patterns by reducing the number of access points from three to one, eliminating towing operations and providing a sidewalk.

In Transportation Section 2.C, Opportunities, #8, the Comprehensive Plan Update recommends that the Town “consider encouraging smaller scale commercial areas to be closer to residential neighborhoods; thus, reducing the likelihood that people will need to drive extended distances to access everyday needs.” As noted above, the project site is located just north of the Balmville Hamlet and as part of the project a sidewalk will be constructed along Route 9W furthering goals to increase pedestrianization.

Another important recommendation per Section 3.C.14 of the Comprehensive Plan is to capitalize on the tourism initiatives currently underway in neighboring communities in

Sullivan and Ulster Counties, “by investigating types of businesses that would benefit from the tourism traffic that passes through the Town.” The requested variances would assist in bringing a business that is supported by and supportive of tourism.

(b) That for reasons fully set forth in the findings of the Board, the aforesaid circumstances or conditions are such that the strict application of the provisions of this chapter would deprive the appellant or applicant of the reasonable use of such land or building and the granting of the variance is necessary for the reasonable use of the land or building and that the variance which is granted by the Board is the minimum variance that will accomplish this purpose.

Due to the split zoned condition of the existing tax parcel and the proposed operation of an auto body/auto repair business and residential uses on the site, the requested variance is the minimum variance that could be requested by the Applicant.

(c) That the granting of the variance will be in harmony with the general purposes and intent of this chapter and will not be injurious to the neighborhood or otherwise detrimental to the public welfare.

As noted above, the proposed development with a modernized motor vehicle service station replacing the existing motor vehicle service station (fueling facility), is a permitted use by site plan approval of the Planning Board. The site plan will improve current conditions by reducing the number of access drives from three to one; eliminating on-site towing operations, providing a sidewalk and trees along the Route 9W frontage; additional landscaping to screen the proposed auto body/auto repair facility, and the removal of the vehicle storage along Route 9W. Accordingly, the requested variances will assist in improved site conditions, including an aesthetically appealing new building.

The following area variance criteria are found on the Town of Newburgh Zoning Board of Appeals Application.

1. The variance will not produce an undesirable change in the character of the neighborhood or a detriment to nearby properties.

The project site is located on the east side NYS Route 9W in a commercial area of the Town just north of the hamlet of Balmville. The parcel borders Route 9W on the west property line and Albany Post Road on the east property line. Adjacent uses include a motel to the north, a commercial business to the south, vacant commercial property and a residential parcel across Route 9W to the west, residential properties along Albany Post Road to the north and south, and residential property across Albany Post Road to the east. Other nearby uses along Route 9W in this area include small retail and services businesses, a religious facility, an energy company (Depew Energy Co.), another motel, and single-family residences.

The project site already contains commercial uses which include an office, a diesel fueling station and a towing business. The project is located along Route 9W and will improve the appearance of the site with new landscaping and an architecturally pleasing building which is appropriately scaled and well designed, and which screens the view of the existing towing facility located to the rear of the site. In addition, site accesses will be reduced from three to two and street trees and a sidewalk will be added along Route 9W.



As described, no undesirable change or detrimental effect to nearby properties will be created by granting the area variance. The proposed site improvements will result in a more aesthetically pleasing development (including the removal of vehicles stored along the Route 9W frontage) and landscaping and a sidewalk along Route 9W.

2. The benefit sought by the Applicant cannot be achieved by some method, feasible for the Applicant to pursue, other than the variance.

- Relief from the 1,000 foot requirement to the nearest motor vehicle service station due to the proposed convenience store's proximity to Stewart's (+/- 900 feet);
  - The project site has been in operation with a diesel fueling station since at least 1995. The proposed project does not encroach any further into the 1,000 foot setback currently applied to the existing site and Stewart's. While the proposed project does result in a slightly modified use, a truly new use is not being introduced. The project site is constrained by residential zoned area, which does not allow motor vehicle service centers. The site is currently developed with Pat's Towing facility and residential uses. The site plan arranges the modernized motor vehicle service station away from the existing residential uses to reduce potential negative effects. Accordingly, this benefit cannot be achieved by other feasible methods.
- Relief from the 1,000 foot requirement from the convenience store to the auto body/auto repair business;
  - See response above.
- Relief for the accessory structure, which will be located closer to the fronting street than the main structure on the lot;
  - Due to site constraints described above, the existing accessory structure will continue to be located in front of the main structure. Accordingly, this benefit cannot be achieved by other feasible methods.
- Relief for the accessory structure, which is a pre-existing non-compliance where it encroaches on the required minimum side yard. The requested variance will not result in an increased non-compliance;
  - The encroachment into the minimum side yard is pre-existing. Under any site plan or subdivision approval process this variance would be required. Therefore, this benefit cannot be achieved by other feasible methods.
- Relief for the accessory structure, which is a pre-existing non-compliance where it exceeds the 15-foot maximum building height. The requested variance will not result in an increased non-compliance; and

- The exceedance over the maximum permitted height is pre-existing. Therefore, under any site plan or subdivision approval process this variance would be required. Accordingly, this benefit cannot be achieved by other feasible methods.
- Relief for the accessory structure, which is a pre-existing non-compliance where it exceeds the maximum 10% coverage in the yard area. The requested variance will not result in an increased non-compliance.
  - The exceedance over the maximum coverage in the yard area is pre-existing. Therefore, under any site plan or subdivision approval process this variance would be required. Accordingly, this benefit cannot be achieved by other feasible methods.
- Relief from the 1,000 foot requirement to the nearest motor vehicle service station due to the proximity of the proposed auto body/auto repair facility (+/- 950 feet) to Stewart's.
  - The encroachment into the setback area is pre-existing. Therefore, under any site plan or subdivision approval process, where an auto body/auto repair service is proposed, this variance would be required. Accordingly, this benefit cannot be achieved by other feasible methods.

3. The requested area variance is not substantial.

- Relief from the 1,000 foot requirement to the nearest motor vehicle service station or any other establishment dispensing gasoline due to the proposed fueling station's proximity to Stewart's (+/- 900 feet) will result in a 10% encroachment into the required setback.
  - The requested variance is not substantial as it is less than 50%, and currently located (+/- 900 feet) from the Stewart's. Furthermore, the encroachment is no greater than the existing fueling station.
- Relief from the 1,000 foot requirement from the fueling station/convenience store to the auto body/auto repair business will result in a 89% encroachment into the required setback.
  - The requested variance may be considered substantial but remains the most feasible alternative given the proposed creation of an auto body/auto repair facility and retainment of some residential uses. It should be noted that the character of the property will not be altered as the proposed project is a modernization of the existing fueling station, but on a subdivided lot.
- Relief for the accessory structure, which will be located closer to the fronting street than the main structure on the lot will result in a 16% encroachment into the required setback.
  - The requested variance is not substantial as it is less than 50%.

- Relief for the accessory structure, which is a pre-existing non-compliance where it encroaches on the required minimum side yard, will result in a 40% encroachment in the required yard. The requested variance will not result in an increased non-compliance.
  - The requested variance is not substantial as it is less than 50%.
- Relief for the accessory structure, which is a pre-existing non-compliance where it exceeds the 15-foot maximum building height, will result in a 33% increase in height over the maximum allowed. The requested variance will not result in an increased non-compliance.
  - The requested variance is not substantial as it is less than 50%.
- Relief for the accessory structure, which is a pre-existing non-compliance where it exceeds the maximum 10% coverage in the yard area, will result in a 20% increase in coverage over the maximum allowed. The requested variance will not result in an increased non-compliance.
  - The requested variance is not substantial as it is less than 50%.
- Relief from the 1,000 foot requirement to the nearest motor vehicle service station due to the proximity of the auto body/auto repair facility (+/- 950 feet) to Stewart's.
  - The requested variance is not substantial as it is less than 50% and pre-existing.

4. The proposed variance will not have an adverse effect or impact on the physical or environmental conditions in the neighborhood district.

The July 26, 2021 Full Environmental Assessment Form, Part 1 and narrative report assessed the potential for significantly adverse physical or environmental impacts from the proposed project on the following resource areas/conditions:

- Land use, zoning, and public policy;
- Police, fire and emergency services;
- Soils and water resources;
- Utilities;
- Traffic and parking;
- Noise and lighting;
- Solid waste;
- Endangered, threatened and rare species and significant habitat; and
- Historic and archaeological resources.

As explained in the report, the proposed project is not anticipated to result in significantly adverse impacts to the resource areas/conditions noted above. In fact, as explained above, the project will result in improvements to the site including, an aesthetically pleasing building replacing a large expanse of asphalt and vehicular storage; improved traffic safety and circulation through the reduction of access points to the site, and the

addition of landscaping for screening at Route 9W and to screen the auto body/auto repair business.

5. The hardship has not been self-created.

The Applicant desires to develop a modernized motor vehicle service station which will dispense fuel in a location that currently dispenses fuel and has developed a design for that supports the functionalities needed to support this use despite the constraints of the pre-existing uses and the split zoned parcel.

The proposed development will result in improved conditions at the site, including lining Route 9W with trees, providing a sidewalk, replacing asphalt with an architecturally pleasing building and introducing landscaping within the site. For the reasons noted above, the Applicant does not believe that the alleged difficulty is self-created.



Photo 1: View looking north along Route 9W.



Photo 2: View looking northeast.



Photo 3: Looking east.



Photo 4: View looking southeast.



Photo 5: Looking south.





Photo 6: Looking south along Route 9W.



Full Environmental Assessment Form Part 1  
for  
**Proposed Convenience Store with Fuel Pumps**

**5200 Route 9W**  
**Town of Newburgh**  
**Orange County, New York**



Issued: June 27, 2019  
Revised: April 7, 2021  
Revised: July 27, 2021

Prepared for:

Gas Land Petroleum, Inc.  
3 South Ohioville Rd  
New Paltz, New York 12561

Prepared by:

Chazen Engineering, Land Surveying &  
Landscape Architecture Co., D.P.C.  
21 Fox Street Suite 201  
Poughkeepsie, NY 12601  
845-454-3980

Chazen Project No. 81912.00



## TABLE OF CONTENTS

### PROJECT NARRATIVE

1.0	PROJECT DESCRIPTION.....	1
2.0	LAND USE, ZONING, AND PUBLIC POLICY .....	1
2.1	Land Use.....	1
2.2	Town of Newburgh Zoning.....	2
2.3	Public Policy .....	3
2.3.1	Town of Newburgh Comprehensive Plan .....	3
2.3.2	NYS Department of State (DOS) Designated Coastal Zone.....	3
2.3.3	Hudson River Valley Greenway and Natural Heritage Area .....	3
3.0	POLICE, FIRE, & EMERGENCY SERVICES .....	4
4.0	SOILS AND WATER RESOURCES .....	4
4.1	Soils .....	4
4.2	Water Resources .....	5
4.3	Floodplain.....	5
5.0	UTILITIES.....	6
5.1	Water and Wastewater.....	6
5.2	Stormwater .....	6
6.0	TRAFFIC AND PARKING .....	7
6.1	Traffic .....	7
6.2	Parking.....	8
7.0	NOISE AND LIGHTING.....	8
7.1	Noise .....	8
7.2	Lighting.....	8
8.0	SOLID WASTE .....	8
9.0	ENDANGERED, THREATENED AND RARE SPECIES AND SIGNIFICANT HABITAT.....	9
10.0	HISTORIC AND ARCHEOLOGICAL RESOURCES .....	9

### LIST OF TABLES

Table 1:	Characteristics of Soil Types within Project Area .....	5
Table 2:	Estimated Water Usage/Wastewater Generation .....	6
Table 3:	Estimated Traffic Generation .....	7

### FULL ENVIRONMENTAL ASSESSMENT FORM PART 1 FORM

## FIGURES

- Figure 1: USGS Location Map
- Figure 2: Orthophoto Tax Map
- Figure 3: Zoning Map
- Figure 4: Land Use Map
- Figure 5: Soils Map
- Figure 6: Wetland, Stream, and Floodplain Map
- Figure 7: NYSDEC Environmental Resource Map
- Figure 8: NYSOPRHP Cultural Resource Information System (CRIS) Map
- Figure 9: Map of Publicly Accessible Federal, State, or Local Scenic or Aesthetic Resources

## ATTACHMENTS

- Attachment A: Endangered and Threatened Species Information
- Attachment B: Pat's Towing Letter
- Attachment C: Typical Underground Petroleum Storage Tank Drawing

Note: Site Plan Set submitted separately.

## PROJECT NARRATIVE

---





## 1.0 PROJECT DESCRIPTION

Gas Land Petroleum, Inc., (the Applicant) is under contract to purchase a 4.518-acre parcel located at 5200 NYS Route 9W in the Town of Newburgh. The parcel is identified as Section 43, Block 5, Lot 1 on the Town of Newburgh tax map, and is owned by P&J Property Walnut St LLC. The site currently contains a diesel fueling station, small office building, a towing business with repair shop for its commercial vehicles, a single-family home, and an accessory barn with a one-bedroom apartment. The Applicant is proposing the construction of a 2,940 square foot (SF) convenience store with six fuel pumps (12 fueling positions), two diesel pumps (4 fueling positions) for tractor trailers, and associated parking. The existing office building will be removed and the fueling operations will continue with the addition of gasoline. The towing use will be abandoned and the existing repair shop will remain on site in connection with the motor vehicle service station. The single-family residence will be removed. The barn with apartment will remain. All existing car storage on the front of the site will be removed. The 4.518-acre parcel has frontage along NYS Route 9W along the western property line and Albany Post Road along the eastern property line. Several access drives exist along NYS Route 9W.

The existing uses are served by water supply wells and subsurface sewage disposal systems (SSDS). Since the site is located in the Newburgh Consolidated Water District, the project includes abandonment of the existing wells and connection of all uses to municipal water service. A new SSDS is proposed to serve the convenience store with fuel pumps, and existing apartment. The existing SSDS will be utilized for the auto repair facility. The well abandonment and water connection will require approval by the Orange County Department of Health (OCDOH).

For the purpose of this Full Environmental Assessment Form (FEAF) Part 1, the project area is defined as the 4.518± acre parcel which is the subject of the proposed site plan and area variances application. The FEAF was completed utilizing the NYSDEC EAF Mapper. The EAF Mapper tool sometimes indicates limited availability for certain digital data. This narrative provides clarification for certain responses and/or reference used for the responses.

## 2.0 LAND USE, ZONING, AND PUBLIC POLICY

### 2.1 Land Use

The project site is located on the east side NYS Route 9W in a commercial area of the Town just north of the hamlet of Balmville. Figure 3 shows land uses within 1,000 feet of the project site. The parcel borders NYS Route 9W on the west property line and Albany Post Road on the east property line. Adjacent uses include a motel to the north, a commercial business to the south, vacant commercial property and a residential parcel across NYS Route 9W to the west, residential properties along Albany Post Road to the north and south, and residential property across Albany Post Road to the east. Other nearby uses along NYS Route 9W in this area include small retail and services businesses, a religious facility, an energy company (Depew Energy Co.), another motel, and single-family residences. The project site already contains commercial uses which include an office, a diesel fueling station and a towing business. The project is located along NYS Route 9W, and will improve the appearance of the site with new landscaping and an architecturally pleasing building which is appropriately scaled and well designed, and which screens the view of the auto repair facility located to the rear of the site. Thus, the project is likely to increase property values in the area and is compatible with the neighborhood.

## 2.2 Town of Newburgh Zoning

The project parcel is situated in two zoning districts and an overlay district, according to the Town of Newburgh Zoning Map. The front portion is located in the Business (B) zoning district and the “Light and Heavy Equipment and Recreational Vehicle Sales, Service and Repair” (LHI) Overlay. The rear portion of the parcel is located in the R3 Residential District. The zoning across Route 9W from the site is R2 with Professional Office (O) Overlay and B with LHI Overlay.

“Convenience stores with or without gasoline filling stations” and “motor vehicle service stations” are permitted in the B district subject to site plan review by the Planning Board. A table that shows the compliance of proposed site with the bulk requirements is provided on the Site Plan. As noted, the following area variances are being sought:

- 1) 185-15(B) - accessory structure closer to fronting street than main structure;
- 2) 185-28(G) - 1,000-foot setback from Stewarts to convenience store with gasoline filling station;
- 3) 185-28(G) - 1,000-foot setback from Stewarts to motor vehicle service station;
- 4) 185-28(G) - 1,000-foot setback from convenience store with gasoline filling station to motor vehicle service station;
- 5) 185-15(A)1 - building height - accessory building;
- 6) 185-15(A)3 - maximum coverage in yard - accessory building; and
- 7) 185-11 - minimum side yard – accessory building

Required parking for a “retail store, shopping center and personal service store” is 1 per 150 SF of gross leasable floor space per Section 185-13.C(1)(b), which results in 20 required parking spaces for the proposed 2,940 SF convenience store. The proposed site plan provides 24 parking spaces for this use, including 12 spaces at the fuel pumps.

Required parking for a “repair garage” is 1 space for all vehicles being serviced at any period of time, plus a minimum of 5 additional spaces per Section 185-13.C(1)(b), which results in 8 required parking spaces for the existing garage. The proposed site plan provides 19 parking spaces for this use.

A one residential single-family unit requires 2 parking spaces per Section 185-13.C(1)(a). The proposed site plan provides 2 parking spaces for this use.

The project will result in improvements to the site including, an aesthetically pleasing building replacing a large expanse of asphalt and vehicular storage; improved traffic safety and circulation through the reduction of access points to the site, and the addition of landscaping for screening at Route 9W and to screen the auto body/auto repair business. Five of the proposed six variances will bring existing nonconformances related to required minimum side yard, maximum coverage in required yard, maximum height, 1,000-foot setback from existing motor vehicle service station to other gasoline fueling or service stations, and required setback of accessory building behind main structure into conformance. The remaining two variances are proposed to allow the gasoline filling station within 1,000 feet of an existing, off-site gasoline filling station and to allow a gasoline filling station on the same lot as the existing motor vehicle service station.

Therefore, no significant adverse impacts related to land use or zoning will result from the project.

## **2.3 Public Policy**

### **2.3.1 Town of Newburgh Comprehensive Plan**

The Town of Newburgh adopted its original Master Plan in 1991, and a Comprehensive Plan Update in 2005. The Comprehensive Plan Update noted that the Town of Newburgh enjoys a strategic location for development due to its location adjacent to major interstate highways and a regional airport. It recognizes Route 9W as a major north-south corridor. The purpose of the Comprehensive Plan Update was to proactively direct growth and development and provide recommendations to alleviate key concerns which include promoting economic development. The Comprehensive Plan Update's Short Term Action Items and Long Term Action Items in regard to transportation both include to "study ways to accommodate the future expansion of Route 9W." A Route 9W Preliminary Corridor Analysis was prepared by Saccardi & Schiff, Inc., in March 2004, and the Comprehensive Plan Update recommended further study of this corridor to evaluate potential improvements and provide direction for future land use patterns. In Transportation Section 2.C, *Opportunities*, #8, the Comprehensive Plan Update recommends that the Town "consider encouraging smaller scale commercial areas to be closer to residential neighborhoods; thus, reducing the likelihood that people will need to drive extended distances to access everyday needs." Another important recommendation per Section 3.C.14 is to capitalize on the tourism initiatives currently underway in neighboring communities in Sullivan and Ulster Counties," by investigating types of businesses that would benefit from the tourism traffic that passes through the Town. The project is consistent with the recommendations of the Comprehensive Plan Update in that it is located just north of the hamlet of Balmville and will serve the neighboring residents and businesses while also taking advantage of tourist traffic through the area. The project will improve the appearance of the site with new landscaping and an architecturally pleasing building which is appropriately scaled and well designed. The removal of the impoundment area will improve the aesthetics of proposed site.

### **2.3.2 NYS Department of State (DOS) Designated Coastal Zone**

The project site is located within a designated coastal zone, according to the NYSDOS coastal boundary map. The Town of Newburgh does not have an approved Local Waterfront Revitalization Plan (LWRP). The project site is located over a half mile from the Hudson River. Due to the elevation increase between the project site and the River, the project is not visible from the River and will not affect any scenic views. Since the project does not require any Federal permits and is not an action undertaken by a State agency, a NYSDOS coastal consistency review is not expected to be required.

### **2.3.3 Hudson River Valley Greenway and Natural Heritage Area**

Orange County is a designated Hudson River Valley Greenway Compact County, and the Town of Newburgh is within the Hudson River Valley Natural Heritage Area, which extends along the Hudson River Valley from Saratoga Springs to near New York City. There are no Natural Heritage Area Sites in the vicinity of the project, and no trails within or adjacent to the project site. The Hudson River Valley Greenway Act of 1991, revised 2012, sets forth the following criteria as a basis for attaining the goals of the Hudson River Valley Greenway:

- Natural and Cultural Resource Protection: Protect, preserve and enhance natural resources including natural communities, open spaces and scenic areas as well as cultural resources including historic places and scenic roads.
- Economic Development: Encourage economic development that is compatible with the preservation and enhancement of natural and cultural resources including agriculture, tourism and the revitalization of established community centers and waterfronts.
- Public Access: Promote increased public access to the Hudson River through the creation of riverside parks and the development of the Hudson River Valley Greenway Trail System.
- Regional Planning: Communities can work together to develop mutually beneficial regional strategies for natural and cultural resource protection, economic development (including necessary public facilities and infrastructure), public access and heritage and environmental education
- Heritage and Environmental Education: Promote awareness among residents and visitors about the Valley's natural, cultural, scenic and historic resources

As described in other sections of this document, the project is consistent with or would have no impact on the criteria established by the Hudson Valley Greenway Act.

### **3.0 POLICE, FIRE, & EMERGENCY SERVICES**

The Town of Newburgh Police Department provides police protection in this area, with support from the Orange County Sheriff's Department and NYS Police. The project site is located in the Middlehope Fire District. The proposed building and pumps would be adequately accessible for fire and police protection. Furthermore, the facility would be well-lit, thereby discouraging criminal activities, and would feature indoor and outdoor security cameras. The Fire Department will have the opportunity to review the proposed site plan and provide comments. Based on the above information and design components, the project is not expected to result in any significant adverse impacts in regard to police, fire, or emergency services.

### **4.0 SOILS AND WATER RESOURCES**

#### **4.1 Soils**

Figure 5 shows the soil types that are expected to be present on the project site, and Table 1 provides characteristics of these soil types, according to Orange County Soil Survey information available in GIS and the Natural Resource Conservation Service website.

**Table 1: Characteristics of Soil Types within Project Area**

SOIL SYMBOL	SOIL TYPE	SLOPES	DRAINAGE	DEPTH TO WATER TABLE (INCHES)	DEPTH TO BEDROCK (INCHES)
Du	Dumps	level to undulating	NA	NA	>24
MdD	Mardin gravelly silt loam, 15 to 25% slopes	15 to 25%	moderately well	13 to 24	14 to 26 to fragipan; >72 to BR
MdC	Mardin gravelly silt loam, 8 to 15% slopes	8 to 15%	moderately well	13 to 24	14 to 26 to fragipan; >72 to BR

The soil on the front half of the site is characterized as being previously filled. The remainder of the property consists of the Mardin gravelly silt loam (MdD or MdC).

#### 4.2 Water Resources

According to NYSDEC Wetland and Stream information available through GIS (Figure 6), the EAF Mapper, and Environmental Resource Map (Figure 8), the project site does not contain any mapped National Wetland Inventory (NWI) or NYSDEC regulated wetlands or associated adjacent areas. The mapping shows a NYSDEC Class C stream (862-360) flowing through the southwest corner of the site, which is a tributary of the Hudson River. There are no surface streams on the site. There is a 24-inch to the north and south of the property, which traverses through the site, which is in proximity to where the NYSDEC map indicates a stream. The proposed project will require a stormwater pollution prevention plan (SWPPP) as discussed in Section 5.3, which will further ensure no significant adverse impacts to aquatic resources located nearby.

In addition, the proposed project will include the installation of two, 12,000 gallon, underground diesel fuel bulk storage tanks. The double walled fiberglass tanks will feature a monitoring space between the walls to allow for the containment of leaked product from the primary tank and continuous automatic leak detection functions (see Attachment C). The new tanks will require NYSDEC registration for underground bulk petroleum storage. Specifically, Article 12, Title 10 of the Environmental Conservation Law, "Control of Bulk Storage of Petroleum," regulates how fuel is stored and dispensed. The NYSDEC has regularly updated these standards to ensure that the risk associated with handling petroleum is minimized. Facility registration with NYSDEC ensures compliance with these standards.

#### 4.3 Floodplain

According to FEMA information available through GIS (Figure 6), there are no areas of 100-year floodplain on or directly adjacent to the project site.

## 5.0 UTILITIES

### 5.1 Water and Wastewater

The project site is currently served by individual water supply wells and several SSDS's. The project site is located within the Newburgh Consolidated Water District, and the existing residences and business as well as the project will be connected to this municipal water supply along Albany Post Road. The location of the existing wells will be determined, and these wells will be abandoned. Municipal sewer service is not available to the site. Several subsurface sewage disposal systems exist on the site, which will be abandoned for the former residence and office. A new SSDS would be installed to serve the new convenience store with fuel pumps, and an additional new SSDS will serve the existing residential use. The existing SSDS will be utilized for the auto repair facility. Town of Newburgh and Health Department approvals will be required for the well abandonment, new SSDS's, and municipal water connections.

Table 2 provides estimated water usage/wastewater generation for each of the uses on the site, based on the NYSDEC Design Standards for Intermediate Sized Wastewater Treatment Systems, March 2014.

**Table 2: Estimated Water Usage/Wastewater Generation**

Use	Rate	Calculated Water Usage/Wastewater Generation	Water Usage/Wastewater Generation after 20% Adjustment for Water Saving Plumbing Fixtures
Existing apartment with a total of 1 bedroom	110 gpd per bedroom	110 gpd	110 gpd (reduction is already incorporated into rate)
Auto repair facility repair shop with 3 employees	15 gpd per employee	45 gpd	36 gpd
Proposed convenience store with fuel pumps (1 toilet)	400 gpd per toilet	400 gpd	320 gpd
Total:			466 gpd

It is anticipated that sufficient capacity exists to provide water service to the project. Therefore, no significant adverse impacts related to water supply or sewage disposal are anticipated.

### 5.2 Stormwater

The project will require 1.737 acres of disturbance, which requires coverage under the State Pollutant Discharge Elimination System (SPDES) General Permit for Stormwater Discharges from Construction Activity. The project is a redevelopment project that results in a decrease in impervious surface. A SWPPP will be prepared in conformance with the New York State Stormwater Management Design Manual and New York State Standards and Specifications for Erosion and Sediment Control. Stormwater management will consist of hydrodynamic oil water separators. An Erosion and Sediment Control Plan will be provided and employed during the construction phase to protect off-site waters from the adverse effects of

sedimentation and erosion. Therefore, the project is not expected to result in any significant adverse impacts in regard to stormwater.

## 6.0 TRAFFIC AND PARKING

### 6.1 Traffic

The project site has several existing access drives from NYS Route 9W. The project includes access improvements to provide one access drive to the new convenience store facility that will also serve the remaining uses, resulting in the elimination of two driveways from Route 9W. The ITE Trip Generation Manual<sup>1</sup> Land Use Code 945, Gasoline/Service Station with Convenience Market, is described as a facility with between 2,000 and 3,000 SF gross floor area and at least 10 fueling positions, which is consistent with the project. The ITE Trip Generation Manual<sup>2</sup> Land Use Code 942, Automobile Care Center, is described as a facility that provides automobile-related services, such as repair and servicing, which is consistent with the project. Table 3 provides estimated weekday AM and PM peak hour of adjacent street traffic trip generation for these Land Use Codes. A portion of the trips can be attributed to pass-by trips, which represent traffic that would already be passing by the site, and are not new trips added to the adjacent streets by the proposed use<sup>3</sup>.

**Table 3: Estimated Traffic Generation**

LAND USE		AM	AM	Peak	PM	PM	Peak
	Land Use Code	Rate per fueling position	Rate per bay	Trips	Rate per fueling position	Rate per bay	Trips
Gasoline/Service Station with Convenience Market (16 fueling positions)	945	12.47		199.52	13.99		223.84
Pass-by Trips		62%		123.7	56%		125.35
Automobile Care Center (3 bays)	942		1.52	4.56		2.17	6.51
Pass-by Trips			62%	2.83		56%	3.65
Volume Added to Adjacent Streets				77.55			101.35

As shown in Table 3, the project may add 77 vehicle trips to the adjacent roads during the weekday AM peak hour of adjacent street traffic and 101 vehicle trips during the weekday PM peak hour of adjacent street traffic. With consideration of the traffic that was generated by the existing diesel fueling station and office building which will be eliminated, the increase in AM and PM peak hour trips resulting from the project would be less than these rates. The project is not expected to result in any significant adverse impacts related to traffic in the vicinity of the site.

In addition to employee and customer traffic, approximately six to seven fuel truck deliveries are anticipated per month.

<sup>1</sup> Institute of Transportation Engineers (ITE) Traffic Generation, 10th Edition, September 2017.

<sup>2</sup> Institute of Transportation Engineers (ITE) Traffic Generation, 10th Edition, September 2017.

<sup>3</sup> ITE Trip Generation Handbook, 3<sup>rd</sup> Edition, September 2017.

Temporary traffic generated during demolition and construction activities includes construction employees and the delivery of equipment and materials. Impacts related to construction are temporary and are not expected to be significant.

## **6.2 Parking**

Required parking for a “retail store, shopping center and personal service store” is 1 per 150 SF of gross leasable floor space per Section 185-13.C(1)(b), which results in 20 required parking spaces for the proposed 2,940 SF convenience store. The proposed site plan provides 24 parking spaces, including 12 spaces at the fuel pumps.

## **7.0 NOISE AND LIGHTING**

### **7.1 Noise**

The project is not expected to result in an increase in noise levels above local ambient noise levels during operation of the facility, since the project is located in a commercial area of NYS Route 9W and already contains commercial uses. Construction activities may result in temporary noise that exceeds local ambient noise levels. These activities will be limited to the hours of 8:00 AM to 10:00 PM, in accordance with Town Code Chapter 125. Therefore, the project is not expected to result in any significant adverse impacts with regard to noise.

### **7.2 Lighting**

The facility would be well-lit, thereby discouraging criminal activities. All exterior lighting will be downward-directed and directed away from adjoining streets and properties so as not to cause any objectionable glare on the streets or properties, in accordance with Chapter 125 Section 125-9. The existing residence on the site is over 100 feet from the nearest parking space at the proposed facility.

## **8.0 SOLID WASTE**

Demolition debris resulting from the removal of the existing office building and other structures will be hauled to a licensed construction debris or solid waste landfill for disposal.

During operation of the proposed facility, solid waste will be collected in a refuse container located onsite. The refuse container will be screened within an enclosure constructed of opaque masonry materials. Solid waste generated in Orange County would be transported regularly by a licensed waste hauler to the Orange County Transfer Station #2 in Newburgh, prior to being transported to a solid waste disposal facility.

According to the Development Impact Assessment Handbook, Urban Land Institute, 1994, a retail use would generate  $0.001\pm$  tons of solid waste per retail employee per day, which results in 0.004 tons per day or 0.12 tons per month for the proposed facility with up to four employees. It is anticipated that sufficient capacity exists to accept solid waste from the project. Therefore, no significant adverse impacts related to the additional solid waste are anticipated.



## **9.0 ENDANGERED, THREATENED AND RARE SPECIES AND SIGNIFICANT HABITAT**

According to the NYSDEC Environmental Resource Mapper (Figure 8), there are known occurrences of endangered, threatened, or rare species on or in the vicinity of the project site, and the FEAF Mapper automated responses indicate the potential for the Indiana bat in the vicinity of the site. An information request was submitted to NYSDEC for further information. In a July 22, 2019 letter, the NYSDEC stated, "We have no records of rare or state-listed animals or plants, or significant natural communities at the project site or in its immediate vicinity. Within 2.5 miles of the project site are several documented maternity colonies of Indiana bat (*Myotis sodalis*, state and federally listed as Endangered). These bats may travel 2.5 miles or more from documented locations. The main impact of concern for bats is the cutting or removal of potential roost trees."

According to the US Fish & Wildlife Service (USFWS) Official Species List (Attachment A), there is potential for the following species in the vicinity of the project site: Indiana bat (State and Federally endangered); northern long-eared bat (State and Federally threatened); bog turtle (State endangered and Federally threatened); dwarf wedgemussel (State and Federally endangered); and small whorled pogonia (State and Federally threatened). The project site consists of developed, previously disturbed area with a significant amount of gravel parking and driveways. The area of the proposed convenience store with fuel pumps consists of impervious surface and gravel. There are no wetlands on the site suitable for bog turtle, and only a few trees may be removed for the temporary disturbance for water line installation. Therefore, no impacts to any of these species are anticipated.

## **10.0 HISTORIC AND ARCHEOLOGICAL RESOURCES**

According to the NYS Office of Parks, Recreation, and Historic Preservation (NYSOPRHP) Cultural Resource Information System (CRIS) mapping (Figure 9), there are no National or State Historic Register sites or eligible sites on or adjacent to the project site, and the site is not located within a known archeologically sensitive area.



**FULL ENVIRONMENTAL ASSESSMENT FORM (FEAF)  
PART 1 FORM**

---



**Full Environmental Assessment Form**  
**Part 1 - Project and Setting**

**Instructions for Completing Part 1**

**Part 1 is to be completed by the applicant or project sponsor.** Responses become part of the application for approval or funding, are subject to public review, and may be subject to further verification.

Complete Part 1 based on information currently available. If additional research or investigation would be needed to fully respond to any item, please answer as thoroughly as possible based on current information; indicate whether missing information does not exist, or is not reasonably available to the sponsor; and, when possible, generally describe work or studies which would be necessary to update or fully develop that information.

Applicants/sponsors must complete all items in Sections A & B. In Sections C, D & E, most items contain an initial question that must be answered either “Yes” or “No”. If the answer to the initial question is “Yes”, complete the sub-questions that follow. If the answer to the initial question is “No”, proceed to the next question. Section F allows the project sponsor to identify and attach any additional information. Section G requires the name and signature of the applicant or project sponsor to verify that the information contained in Part 1 is accurate and complete.

**A. Project and Applicant/Sponsor Information.**

Name of Action or Project: Proposed convenience store with fuel pumps		
Project Location (describe, and attach a general location map): 5200 Route 9W, Town of Newburgh, Orange County, NY; Tax Parcel Section 43 Block 5 Lot 1. Refer to Figures 1 and 2.		
Brief Description of Proposed Action (include purpose or need): Gas Land Petroleum, Inc., is under contract to purchase a 4.518-acre parcel located at 5200 NYS Route 9W in the Town of Newburgh. The site currently contains a diesel fueling station, small office building, a towing business with repair shop for its vehicles, a single family home, and an accessory barn with apartment. The Applicant is proposing to construct a 2,940 square foot (SF) convenience store with six fuel pumps (12 fueling positions), two diesel pumps (4 fueling positions) and associated parking. The existing diesel fueling station, towing operations, office building, and single family residence will be removed. The towing use will be abandoned and the existing repair shop will remain on site in connection with the motor vehicle service station. The barn with apartment will remain. There will be no more impounded vehicles on the site. The existing uses are served by water supply wells and subsurface sewage disposal systems (SSDS). Since the site is located in the Newburgh Consolidated Water District, the project includes abandonment of the existing wells and connection of all uses to municipal water service. A new SSDS is proposed to serve the convenience store with fuel pumps, and existing apartment. The existing SSDS will be utilized for the auto repair facility.		
Name of Applicant/Sponsor: Gas Land Petroleum, Inc. (Zeidan Nesheiwat, Vice President)		Telephone: 845-331-7545 E-Mail: gasland.zeidan@gmail.com
Address: 3 South Ohioville Rd		
City/PO: New Paltz	State: NY	Zip Code: 12561
Project Contact (if not same as sponsor; give name and title/role): The Chazen Companies (Christopher P. Lapine, P.E.)		Telephone: 845-486-1478 E-Mail: clapine@chazencompanies.com
Address: 21 Fox St		
City/PO: Poughkeepsie	State: NY	Zip Code: 12601
Property Owner (if not same as sponsor): P&J Property Walnut St LLC		Telephone: E-Mail:
Address: 24 Walnut Street		
City/PO: New Windsor	State: NY	Zip Code: 12553

**B. Government Approvals**

<b>B. Government Approvals, Funding, or Sponsorship.</b> (“Funding” includes grants, loans, tax relief, and any other forms of financial assistance.)		
<b>Government Entity</b>	<b>If Yes: Identify Agency and Approval(s) Required</b>	<b>Application Date (Actual or projected)</b>
a. City Counsel, Town Board, <input type="checkbox"/> Yes <input checked="" type="checkbox"/> No or Village Board of Trustees		
b. City, Town or Village Planning Board or Commission <input checked="" type="checkbox"/> Yes <input type="checkbox"/> No	site plan and SSDS approval	March 2021
c. City, Town or Village Zoning Board of Appeals <input checked="" type="checkbox"/> Yes <input type="checkbox"/> No	Area variances, see Note 1 below	July 2021
d. Other local agencies <input type="checkbox"/> Yes <input checked="" type="checkbox"/> No		
e. County agencies <input checked="" type="checkbox"/> Yes <input type="checkbox"/> No	OCDOH for well abandonment, OC Planning 239m referral	To be determined
f. Regional agencies <input type="checkbox"/> Yes <input checked="" type="checkbox"/> No		
g. State agencies <input checked="" type="checkbox"/> Yes <input type="checkbox"/> No	NYS DOT Highway Work Permits; NYSDEC GP-0-20-001	To be determined
h. Federal agencies <input type="checkbox"/> Yes <input checked="" type="checkbox"/> No		
i. Coastal Resources.		
i. Is the project site within a Coastal Area, or the waterfront area of a Designated Inland Waterway?		<input checked="" type="checkbox"/> Yes <input type="checkbox"/> No <small>(EAF Mapper automated response)</small>
ii. Is the project site located in a community with an approved Local Waterfront Revitalization Program?		<input type="checkbox"/> Yes <input checked="" type="checkbox"/> No <small>(EAF Mapper automated response)</small>
iii. Is the project site within a Coastal Erosion Hazard Area?		<input type="checkbox"/> Yes <input checked="" type="checkbox"/> No <small>(EAF Mapper automated response)</small>

**C. Planning and Zoning**

<b>C.1. Planning and zoning actions.</b>	
Will administrative or legislative adoption, or amendment of a plan, local law, ordinance, rule or regulation be the only approval(s) which must be granted to enable the proposed action to proceed?	<input type="checkbox"/> Yes <input checked="" type="checkbox"/> No
<ul style="list-style-type: none"> <li>• <b>If Yes</b>, complete sections C, F and G.</li> <li>• <b>If No</b>, proceed to question C.2 and complete all remaining sections and questions in Part 1</li> </ul>	
<b>C.2. Adopted land use plans.</b>	
a. Do any municipally- adopted (city, town, village or county) comprehensive land use plan(s) include the site where the proposed action would be located?	<input checked="" type="checkbox"/> Yes <input type="checkbox"/> No
If Yes, does the comprehensive plan include specific recommendations for the site where the proposed action would be located? <a href="#">Refer to FEAF Narrative Section 2.2.</a>	<input checked="" type="checkbox"/> Yes <input type="checkbox"/> No
b. Is the site of the proposed action within any local or regional special planning district (for example: Greenway; Brownfield Opportunity Area (BOA); designated State or Federal heritage area; watershed management plan; or other?)	<input checked="" type="checkbox"/> Yes <input type="checkbox"/> No
If Yes, identify the plan(s): Hudson River Valley National Heritage Area; Hudson River Greenway Compact Community (Orange County)	
_____	
_____	
c. Is the proposed action located wholly or partially within an area listed in an adopted municipal open space plan, or an adopted municipal farmland protection plan?	<input checked="" type="checkbox"/> Yes <input type="checkbox"/> No
If Yes, identify the plan(s): Orange County Agricultural and Farmland Protection Plan (there are no agricultural uses on or near the project site)	
_____	
_____	

Note 1: Area Variances Requested:

- 1) 185-15(B) - accessory structure closer to fronting street than main structure;
- 2) 185-28(G) - 1,000-foot setback from Stewarts to convenience store with gasoline filling station;
- 3) 185-28(G) - 1,000-foot setback from Stewarts to motor vehicle service station;
- 4) 185-28(G) - 1,000-foot setback from convenience store with gasoline filling station to motor vehicle service station;
- 5) 185-15(A)1 - building height - accessory building; and
- 6) 185-15(A)3 - maximum coverage in yard - accessory building
- 7) 185-11 - minimum side yard - accessory building

**C.3. Zoning**

a. Is the site of the proposed action located in a municipality with an adopted zoning law or ordinance.  Yes  No  
 If Yes, what is the zoning classification(s) including any applicable overlay district?  
 \_\_\_\_\_

b. Is the use permitted or allowed by a special or conditional use permit?  Yes  No

c. Is a zoning change requested as part of the proposed action?  Yes  No  
 If Yes,  
 i. What is the proposed new zoning for the site? \_\_\_\_\_

**C.4. Existing community services.**

a. In what school district is the project site located? Newburgh School District

b. What police or other public protection forces serve the project site?  
Town of Newburgh Police Department with support from Orange County Sheriff's Department and NYS Police

c. Which fire protection and emergency medical services serve the project site?  
Middlehope Fire District

d. What parks serve the project site?  
Cronomer Hill County Park; Chadwick Lake Park; Storm King State Park; other local parks

**D. Project Details**

**D.1. Proposed and Potential Development**

a. What is the general nature of the proposed action (e.g., residential, industrial, commercial, recreational; if mixed, include all components)? commercial and residential

b. a. Total acreage of the site of the proposed action? \_\_\_\_\_ 4.518 acres  
 b. Total acreage to be physically disturbed? \_\_\_\_\_ 1.737 acres  
 c. Total acreage (project site and any contiguous properties) owned or controlled by the applicant or project sponsor? \_\_\_\_\_ 4.518 acres

c. Is the proposed action an expansion of an existing project or use?  Yes  No  
 i. If Yes, what is the approximate percentage of the proposed expansion and identify the units (e.g., acres, miles, housing units, square feet)? % \_\_\_\_\_ Units: \_\_\_\_\_

d. Is the proposed action a subdivision, or does it include a subdivision?  Yes  No  
 If Yes,  
 i. Purpose or type of subdivision? (e.g., residential, industrial, commercial; if mixed, specify types) \_\_\_\_\_  
 ii. Is a cluster/conservation layout proposed?  Yes  No  
 iii. Number of lots proposed? \_\_\_\_\_  
 iv. Minimum and maximum proposed lot sizes? Minimum \_\_\_\_\_ Maximum \_\_\_\_\_

e. Will the proposed action be constructed in multiple phases?  Yes  No  
 i. If No, anticipated period of construction: \_\_\_\_\_ 10 months  
 ii. If Yes:  
 • Total number of phases anticipated \_\_\_\_\_  
 • Anticipated commencement date of phase 1 (including demolition) \_\_\_\_\_ month \_\_\_\_\_ year  
 • Anticipated completion date of final phase \_\_\_\_\_ month \_\_\_\_\_ year  
 • Generally describe connections or relationships among phases, including any contingencies where progress of one phase may determine timing or duration of future phases: \_\_\_\_\_  
 \_\_\_\_\_  
 \_\_\_\_\_

f. Does the project include new residential uses?  Yes  No  
 If Yes, show numbers of units proposed.

	<u>One Family</u>	<u>Two Family</u>	<u>Three Family</u>	<u>Multiple Family (four or more)</u>
Initial Phase	_____	_____	_____	_____
At completion	_____	_____	_____	_____
of all phases	_____	_____	_____	_____

g. Does the proposed action include new non-residential construction (including expansions)?  Yes  No  
 If Yes,  
 i. Total number of structures 3 (convenience store and canopies over pumps)  
 ii. Dimensions (in feet) of largest proposed structure: 1 story height; 35' width; and 84' length  
 iii. Approximate extent of building space to be heated or cooled: 2,940 square feet

h. Does the proposed action include construction or other activities that will result in the impoundment of any liquids, such as creation of a water supply, reservoir, pond, lake, waste lagoon or other storage?  Yes  No  
 If Yes,  
 i. Purpose of the impoundment: \_\_\_\_\_  
 ii. If a water impoundment, the principal source of the water:  Ground water  Surface water streams  Other specify: \_\_\_\_\_  
 iii. If other than water, identify the type of impounded/contained liquids and their source. \_\_\_\_\_  
 iv. Approximate size of the proposed impoundment. Volume: \_\_\_\_\_ million gallons; surface area: \_\_\_\_\_ acres  
 v. Dimensions of the proposed dam or impounding structure: \_\_\_\_\_ height; \_\_\_\_\_ length  
 vi. Construction method/materials for the proposed dam or impounding structure (e.g., earth fill, rock, wood, concrete): \_\_\_\_\_

**D.2. Project Operations**

a. Does the proposed action include any excavation, mining, or dredging, during construction, operations, or both?  Yes  No  
 (Not including general site preparation, grading or installation of utilities or foundations where all excavated materials will remain onsite)  
 If Yes:  
 i. What is the purpose of the excavation or dredging? \_\_\_\_\_  
 ii. How much material (including rock, earth, sediments, etc.) is proposed to be removed from the site?  
 • Volume (specify tons or cubic yards): \_\_\_\_\_  
 • Over what duration of time? \_\_\_\_\_  
 iii. Describe nature and characteristics of materials to be excavated or dredged, and plans to use, manage or dispose of them.  
 \_\_\_\_\_  
 iv. Will there be onsite dewatering or processing of excavated materials?  Yes  No  
 If yes, describe. \_\_\_\_\_  
 v. What is the total area to be dredged or excavated? \_\_\_\_\_ acres  
 vi. What is the maximum area to be worked at any one time? \_\_\_\_\_ acres  
 vii. What would be the maximum depth of excavation or dredging? \_\_\_\_\_ feet  
 viii. Will the excavation require blasting?  Yes  No  
 ix. Summarize site reclamation goals and plan: \_\_\_\_\_  
 \_\_\_\_\_

b. Would the proposed action cause or result in alteration of, increase or decrease in size of, or encroachment into any existing wetland, waterbody, shoreline, beach or adjacent area?  Yes  No  
 If Yes:  
 i. Identify the wetland or waterbody which would be affected (by name, water index number, wetland map number or geographic description): \_\_\_\_\_  
 \_\_\_\_\_



ii. Describe how the proposed action would affect that waterbody or wetland, e.g. excavation, fill, placement of structures, or alteration of channels, banks and shorelines. Indicate extent of activities, alterations and additions in square feet or acres:

\_\_\_\_\_  
\_\_\_\_\_  
\_\_\_\_\_

iii. Will the proposed action cause or result in disturbance to bottom sediments?  Yes  No  
If Yes, describe: \_\_\_\_\_

iv. Will the proposed action cause or result in the destruction or removal of aquatic vegetation?  Yes  No  
If Yes:

- acres of aquatic vegetation proposed to be removed: \_\_\_\_\_
- expected acreage of aquatic vegetation remaining after project completion: \_\_\_\_\_
- purpose of proposed removal (e.g. beach clearing, invasive species control, boat access): \_\_\_\_\_
- proposed method of plant removal: \_\_\_\_\_
- if chemical/herbicide treatment will be used, specify product(s): \_\_\_\_\_

v. Describe any proposed reclamation/mitigation following disturbance: \_\_\_\_\_

c. Will the proposed action use, or create a new demand for water? Refer to FEAF Narrative Section 5.1.  Yes  No  
If Yes:

i. Total anticipated water usage/demand per day: \_\_\_\_\_ 466 gallons/day

ii. Will the proposed action obtain water from an existing public water supply?  Yes  No

If Yes:

- Name of district or service area: Newburgh Consolidated Water District
- Does the existing public water supply have capacity to serve the proposal?  Yes  No
- Is the project site in the existing district?  Yes  No
- Is expansion of the district needed?  Yes  No
- Do existing lines serve the project site?  Yes  No

iii. Will line extension within an existing district be necessary to supply the project?  Yes  No  
If Yes:

• Describe extensions or capacity expansions proposed to serve this project: \_\_\_\_\_  
New water supply lines will be installed to connect to the water main along Albany Post Road.

• Source(s) of supply for the district: Chadwick Lake and Delaware Aquaduct (through NYCDEP)

iv. Is a new water supply district or service area proposed to be formed to serve the project site?  Yes  No  
If Yes:

- Applicant/sponsor for new district: \_\_\_\_\_
- Date application submitted or anticipated: \_\_\_\_\_
- Proposed source(s) of supply for new district: \_\_\_\_\_

v. If a public water supply will not be used, describe plans to provide water supply for the project: \_\_\_\_\_

vi. If water supply will be from wells (public or private), what is the maximum pumping capacity: NA gallons/minute.

d. Will the proposed action generate liquid wastes? Refer to FEAF Narrative Section 5.1.  Yes  No  
If Yes:

i. Total anticipated liquid waste generation per day: \_\_\_\_\_ 466 gallons/day

ii. Nature of liquid wastes to be generated (e.g., sanitary wastewater, industrial; if combination, describe all components and approximate volumes or proportions of each): \_\_\_\_\_

sanitary sewage

iii. Will the proposed action use any existing public wastewater treatment facilities?  Yes  No  
If Yes:

- Name of wastewater treatment plant to be used: \_\_\_\_\_
- Name of district: \_\_\_\_\_
- Does the existing wastewater treatment plant have capacity to serve the project?  Yes  No
- Is the project site in the existing district?  Yes  No
- Is expansion of the district needed?  Yes  No

- Do existing sewer lines serve the project site?  Yes  No
- Will a line extension within an existing district be necessary to serve the project?  Yes  No

 If Yes:
 

- Describe extensions or capacity expansions proposed to serve this project: \_\_\_\_\_

iv. Will a new wastewater (sewage) treatment district be formed to serve the project site?  Yes  No  
 If Yes:
 

- Applicant/sponsor for new district: \_\_\_\_\_
- Date application submitted or anticipated: \_\_\_\_\_
- What is the receiving water for the wastewater discharge? \_\_\_\_\_

v. If public facilities will not be used, describe plans to provide wastewater treatment for the project, including specifying proposed receiving water (name and classification if surface discharge or describe subsurface disposal plans):  
 Two new subsurface sewage disposal systems (SSDS) and an existing SSDS, which will serve all uses on the site

vi. Describe any plans or designs to capture, recycle or reuse liquid waste: \_\_\_\_\_  
 None \_\_\_\_\_

---

e. Will the proposed action disturb more than one acre and create stormwater runoff, either from new point sources (i.e. ditches, pipes, swales, curbs, gutters or other concentrated flows of stormwater) or non-point source (i.e. sheet flow) during construction or post construction? [Refer to FEAF Narrative Section 5.2.](#)  Yes  No  
 If Yes:
 

- How much impervious surface will the project create in relation to total size of project parcel?  
 \_\_\_\_\_ Square feet or 1.258 acres (impervious surface) ([represents a decrease of 0.399 acre from existing conditions](#))  
 \_\_\_\_\_ Square feet or 4.518 acres (parcel size)
- Describe types of new point sources. None
- Where will the stormwater runoff be directed (i.e. on-site stormwater management facility/structures, adjacent properties, groundwater, on-site surface water or off-site surface waters)?  
 Stormwater management system which will include hydrodynamic oil water separators.
- If to surface waters, identify receiving water bodies or wetlands: \_\_\_\_\_
- Will stormwater runoff flow to adjacent properties?  Yes  No

iv. Does the proposed plan minimize impervious surfaces, use pervious materials or collect and re-use stormwater?  Yes  No

---

f. Does the proposed action include, or will it use on-site, one or more sources of air emissions, including fuel combustion, waste incineration, or other processes or operations?  Yes  No  
 If Yes, identify:
 

- Mobile sources during project operations (e.g., heavy equipment, fleet or delivery vehicles)
- Stationary sources during construction (e.g., power generation, structural heating, batch plant, crushers)
- Stationary sources during operations (e.g., process emissions, large boilers, electric generation)

---

g. Will any air emission sources named in D.2.f (above), require a NY State Air Registration, Air Facility Permit, or Federal Clean Air Act Title IV or Title V Permit?  Yes  No  
 If Yes:
 

- Is the project site located in an Air quality non-attainment area? (Area routinely or periodically fails to meet ambient air quality standards for all or some parts of the year)  Yes  No
- In addition to emissions as calculated in the application, the project will generate:
  - \_\_\_\_\_ Tons/year (short tons) of Carbon Dioxide (CO<sub>2</sub>)
  - \_\_\_\_\_ Tons/year (short tons) of Nitrous Oxide (N<sub>2</sub>O)
  - \_\_\_\_\_ Tons/year (short tons) of Perfluorocarbons (PFCs)
  - \_\_\_\_\_ Tons/year (short tons) of Sulfur Hexafluoride (SF<sub>6</sub>)
  - \_\_\_\_\_ Tons/year (short tons) of Carbon Dioxide equivalent of Hydrofluorocarbons (HFCs)
  - \_\_\_\_\_ Tons/year (short tons) of Hazardous Air Pollutants (HAPs)

h. Will the proposed action generate or emit methane (including, but not limited to, sewage treatment plants, landfills, composting facilities)?  Yes  No

If Yes:

i. Estimate methane generation in tons/year (metric): \_\_\_\_\_

ii. Describe any methane capture, control or elimination measures included in project design (e.g., combustion to generate heat or electricity, flaring): \_\_\_\_\_

---

i. Will the proposed action result in the release of air pollutants from open-air operations or processes, such as quarry or landfill operations?  Yes  No

If Yes: Describe operations and nature of emissions (e.g., diesel exhaust, rock particulates/dust): \_\_\_\_\_

---

j. Will the proposed action result in a substantial increase in traffic above present levels or generate substantial new demand for transportation facilities or services? Refer to FEAF Narrative Section 6.0.  Yes  No

If Yes:

i. When is the peak traffic expected (Check all that apply):  Morning  Evening  Weekend  
 Randomly between hours of \_\_\_\_\_ to \_\_\_\_\_.

ii. For commercial activities only, projected number of truck trips/day and type (e.g., semi trailers and dump trucks): \_\_\_\_\_

---

iii. Parking spaces: Existing \_\_\_\_\_ Proposed \_\_\_\_\_ Net increase/decrease \_\_\_\_\_

iv. Does the proposed action include any shared use parking?  Yes  No

v. If the proposed action includes any modification of existing roads, creation of new roads or change in existing access, describe: \_\_\_\_\_

---

vi. Are public/private transportation service(s) or facilities available within 1/2 mile of the proposed site?  Yes  No

vii. Will the proposed action include access to public transportation or accommodations for use of hybrid, electric or other alternative fueled vehicles?  Yes  No

viii. Will the proposed action include plans for pedestrian or bicycle accommodations for connections to existing pedestrian or bicycle routes?  Yes  No

---

k. Will the proposed action (for commercial or industrial projects only) generate new or additional demand for energy?  Yes  No

If Yes:

i. Estimate annual electricity demand during operation of the proposed action: \_\_\_\_\_  
amount of electric and fuel for heating and air conditioning of the proposed convenience store.

ii. Anticipated sources/suppliers of electricity for the project (e.g., on-site combustion, on-site renewable, via grid/local utility, or other):  
 Central Hudson Gas & Electric Corp.

iii. Will the proposed action require a new, or an upgrade, to an existing substation?  Yes  No

---

l. Hours of operation. Answer all items which apply.

i. During Construction:		ii. During Operations:	
• Monday - Friday:	_____ 8:00 am to 10:00 pm	• Monday - Friday:	_____ 24 hours
• Saturday:	_____ 8:00 am to 10:00 pm	• Saturday:	_____ 24 hours
• Sunday:	_____ NA	• Sunday:	_____ 24 hours
• Holidays:	_____ NA	• Holidays:	_____ 24 hours

m. Will the proposed action produce noise that will exceed existing ambient noise levels during construction, operation, or both?  Yes  No  
 If yes:  
 i. Provide details including sources, time of day and duration:  
 Temporary noise that exceeds local ambient noise levels may occur during construction activities, which will be limited to the hours of 8:00 am to 10:00 pm in accordance with Town Code Chapter 125.

ii. Will the proposed action remove existing natural barriers that could act as a noise barrier or screen?  Yes  No  
 Describe: \_\_\_\_\_

---

n. Will the proposed action have outdoor lighting?  Yes  No  
 If yes:  
 i. Describe source(s), location(s), height of fixture(s), direction/aim, and proximity to nearest occupied structures:  
 All exterior lighting will be downward-directed and directed away from adjoining streets and properties, in accordance with Chapter 125 Section 125-8.. The existing residence on the overall parcel is over 100 feet from the nearest parking space for the convenience store. Refer to FEA Narrative Section 7.2.

ii. Will proposed action remove existing natural barriers that could act as a light barrier or screen?  Yes  No  
 Describe: \_\_\_\_\_

---

o. Does the proposed action have the potential to produce odors for more than one hour per day?  Yes  No  
 If Yes, describe possible sources, potential frequency and duration of odor emissions, and proximity to nearest occupied structures: \_\_\_\_\_

---

p. Will the proposed action include any bulk storage of petroleum (combined capacity of over 1,100 gallons) or chemical products 185 gallons in above ground storage or any amount in underground storage?  Yes  No  
 If Yes:  
 i. Product(s) to be stored gasoline, diesel fuel (two 12,000-gallon tanks). Site contains a 10,000 gal diesel UST (PBS 3-175617) to be removed.  
 ii. Volume(s) TBD per unit time (e.g., month, year)  
 iii. Generally, describe the proposed storage facilities: New double-walled fiberglass tanks and piping will be installed in accordance with NYSDEC requirements, and will require NYSDEC registration.

---

q. Will the proposed action (commercial, industrial and recreational projects only) use pesticides (i.e., herbicides, insecticides) during construction or operation?  Yes  No  
 If Yes:  
 i. Describe proposed treatment(s): \_\_\_\_\_

ii. Will the proposed action use Integrated Pest Management Practices?  Yes  No

---

r. Will the proposed action (commercial or industrial projects only) involve or require the management or disposal of solid waste (excluding hazardous materials)?  Yes  No  
 If Yes:  
 i. Describe any solid waste(s) to be generated during construction or operation of the facility:  
 • Construction: to be determined tons per (unit of time)  
 • Operation : 0.12 tons per month (unit of time) Refer to FEA Narrative Section 8.0.

ii. Describe any proposals for on-site minimization, recycling or reuse of materials to avoid disposal as solid waste:  
 • Construction: To be determined by demolition contractor.  
 • Operation: Recyclables may be separated and picked up for recycling at a recycling center.

iii. Proposed disposal methods/facilities for solid waste generated on-site:  
 • Construction: Demolition debris will be hauled to a licensed demolition debris or solid waste landfill for disposal.  
 • Operation: Solid waste generated by the proposed facility will be picked up regularly by a licensed solid waste hauler for transport to Orange County Transfer Station #2.

s. Does the proposed action include construction or modification of a solid waste management facility?  Yes  No

If Yes:

i. Type of management or handling of waste proposed for the site (e.g., recycling or transfer station, composting, landfill, or other disposal activities): \_\_\_\_\_

ii. Anticipated rate of disposal/processing:

- \_\_\_\_\_ Tons/month, if transfer or other non-combustion/thermal treatment, or
- \_\_\_\_\_ Tons/hour, if combustion or thermal treatment

iii. If landfill, anticipated site life: \_\_\_\_\_ years

t. Will the proposed action at the site involve the commercial generation, treatment, storage, or disposal of hazardous waste?  Yes  No

If Yes:

i. Name(s) of all hazardous wastes or constituents to be generated, handled or managed at facility: \_\_\_\_\_

ii. Generally describe processes or activities involving hazardous wastes or constituents: \_\_\_\_\_

iii. Specify amount to be handled or generated \_\_\_\_\_ tons/month

iv. Describe any proposals for on-site minimization, recycling or reuse of hazardous constituents: \_\_\_\_\_

v. Will any hazardous wastes be disposed at an existing offsite hazardous waste facility?  Yes  No

If Yes: provide name and location of facility: \_\_\_\_\_

If No: describe proposed management of any hazardous wastes which will not be sent to a hazardous waste facility: \_\_\_\_\_

### E. Site and Setting of Proposed Action

#### E.1. Land uses on and surrounding the project site

a. Existing land uses.

i. Check all uses that occur on, adjoining and near the project site. [Refer to FEAF Narrative Section 2.1.](#)

Urban  Industrial  Commercial  Residential (suburban)  Rural (non-farm)

Forest  Agriculture  Aquatic  Other (specify): energy company, religious

ii. If mix of uses, generally describe: diesel fueling station, towing and auto repair business, and single family residence on site; nearby uses include motels, retail and service businesses, religious facility, energy company, residential

b. Land uses and covertsypes on the project site.

Land use or Covertypes	Current Acreage	Acreage After Project Completion	Change (Acres +/-)
• Roads, buildings, and other paved or impervious surfaces	1.657	1.358	-0.299
• Forested	1.665	1.129	-0.536
• Meadows, grasslands or brushlands (non-agricultural, including abandoned agricultural)	0.865	1.269	+0.404
• Agricultural (includes active orchards, field, greenhouse etc.)			
• Surface water features (lakes, ponds, streams, rivers, etc.)			
• Wetlands (freshwater or tidal)			
• Non-vegetated (bare rock, earth or fill)			
• Other Describe: <u>lawn/landscaped area</u>	0.331	0.762	+0.431

c. Is the project site presently used by members of the community for public recreation?  Yes  No  
 i. If Yes: explain: \_\_\_\_\_

d. Are there any facilities serving children, the elderly, people with disabilities (e.g., schools, hospitals, licensed day care centers, or group homes) within 1500 feet of the project site?  Yes  No  
 If Yes,  
 i. Identify Facilities: \_\_\_\_\_

e. Does the project site contain an existing dam?  Yes  No  
 If Yes:  
 i. Dimensions of the dam and impoundment:  
 • Dam height: \_\_\_\_\_ feet  
 • Dam length: \_\_\_\_\_ feet  
 • Surface area: \_\_\_\_\_ acres  
 • Volume impounded: \_\_\_\_\_ gallons OR acre-feet  
 ii. Dam's existing hazard classification: \_\_\_\_\_  
 iii. Provide date and summarize results of last inspection: \_\_\_\_\_

f. Has the project site ever been used as a municipal, commercial or industrial solid waste management facility, or does the project site adjoin property which is now, or was at one time, used as a solid waste management facility?  Yes  No  
 If Yes:  
 i. Has the facility been formally closed?  Yes  No  
 • If yes, cite sources/documentation: \_\_\_\_\_  
 ii. Describe the location of the project site relative to the boundaries of the solid waste management facility: \_\_\_\_\_  
 iii. Describe any development constraints due to the prior solid waste activities: \_\_\_\_\_

g. Have hazardous wastes been generated, treated and/or disposed of at the site, or does the project site adjoin property which is now or was at one time used to commercially treat, store and/or dispose of hazardous waste?  Yes  No  
 If Yes:  
 i. Describe waste(s) handled and waste management activities, including approximate time when activities occurred: \_\_\_\_\_

h. Potential contamination history. Has there been a reported spill at the proposed project site, or have any remedial actions been conducted at or adjacent to the proposed site?  Yes  No  
 If Yes:  
 i. Is any portion of the site listed on the NYSDEC Spills Incidents database or Environmental Site Remediation database? Check all that apply:  Yes  No  
 Yes – Spills Incidents database Provide DEC ID number(s): Spill 9806760 (closed 2-1-2012)  
 Yes – Environmental Site Remediation database Provide DEC ID number(s): \_\_\_\_\_  
 Neither database  
 ii. If site has been subject of RCRA corrective activities, describe control measures: \_\_\_\_\_  
 NA  
 iii. Is the project within 2000 feet of any site in the NYSDEC Environmental Site Remediation database?  Yes  No  
 If yes, provide DEC ID number(s): \_\_\_\_\_ (EAF Mapper automated response)  
 iv. If yes to (i), (ii) or (iii) above, describe current status of site(s): \_\_\_\_\_

Spill 9806760 occurred on the site on 9/1/1998. Spill record indicates that the spill was an unknown quantity of diesel fuel related to PBS 3-175617, resulting from "housekeeping". This spill was closed on 2/1/2012.

v. Is the project site subject to an institutional control limiting property uses?  Yes  No

- If yes, DEC site ID number: \_\_\_\_\_
- Describe the type of institutional control (e.g., deed restriction or easement): \_\_\_\_\_
- Describe any use limitations: \_\_\_\_\_
- Describe any engineering controls: \_\_\_\_\_
- Will the project affect the institutional or engineering controls in place?  Yes  No
- Explain: \_\_\_\_\_

---

**E.2. Natural Resources On or Near Project Site**

a. What is the average depth to bedrock on the project site? \_\_\_\_\_ >2 feet Refer to FEAF Narrative Section 4.1.

b. Are there bedrock outcroppings on the project site?  Yes  No  
 If Yes, what proportion of the site is comprised of bedrock outcroppings? \_\_\_\_\_ %

c. Predominant soil type(s) present on project site:

Dumps (Du)	_____	50 %
Mardin gravelly silt loam (MdD)	_____	40 %
Mardin gravelly silt loam (MdC)	_____	10 %

d. What is the average depth to the water table on the project site? Average: \_\_\_\_\_ TBD feet Refer to FEAF Narrative Section 4.1.

e. Drainage status of project site soils:  Well Drained: \_\_\_\_\_ TBD % of site Refer to FEAF Narrative Section 4.1.  
 Moderately Well Drained: \_\_\_\_\_ 50 % of site  
 Poorly Drained \_\_\_\_\_ TBD % of site

f. Approximate proportion of proposed action site with slopes:  0-10%: \_\_\_\_\_ 46 % of site  
 10-15%: \_\_\_\_\_ 15 % of site  
 15% or greater: \_\_\_\_\_ 39 % of site

g. Are there any unique geologic features on the project site?  Yes  No  
 If Yes, describe: \_\_\_\_\_ (EAF Mapper automated response)

---

h. Surface water features.

i. Does any portion of the project site contain wetlands or other waterbodies (including streams, rivers, ponds or lakes)? Refer to FEAF Narrative Section 4.2.  Yes  No (EAF Mapper automated response)

ii. Do any wetlands or other waterbodies adjoin the project site?  Yes  No (EAF Mapper automated response)

If Yes to either *i* or *ii*, continue. If No, skip to E.2.i.

iii. Are any of the wetlands or waterbodies within or adjoining the project site regulated by any federal, state or local agency?  Yes  No (EAF Mapper automated response)

iv. For each identified regulated wetland and waterbody on the project site, provide the following information:

- Streams: Name 862-360 (tributary of Hudson River) Classification C
- Lakes or Ponds: Name None Classification \_\_\_\_\_
- Wetlands: Name Federal Waters, Federal Waters, Federal Waters,... Approximate Size None on site
- Wetland No. (if regulated by DEC) None

v. Are any of the above water bodies listed in the most recent compilation of NYS water quality-impaired waterbodies?  Yes  No (EAF Mapper automated response)  
 If yes, name of impaired water body/bodies and basis for listing as impaired: \_\_\_\_\_

---

i. Is the project site in a designated Floodway?  Yes  No (EAF Mapper automated response)

j. Is the project site in the 100-year Floodplain?  Yes  No (EAF Mapper automated response)

k. Is the project site in the 500-year Floodplain?  Yes  No (EAF Mapper automated response)

l. Is the project site located over, or immediately adjoining, a primary, principal or sole source aquifer?  Yes  No (EAF Mapper automated response)  
 If Yes:  
 i. Name of aquifer: \_\_\_\_\_

m. Identify the predominant wildlife species that occupy or use the project site: \_\_\_\_\_  
Common urban species \_\_\_\_\_  
\_\_\_\_\_

---

n. Does the project site contain a designated significant natural community?  Yes  No  
(EAF Mapper automated response)  
If Yes:  
i. Describe the habitat/community (composition, function, and basis for designation): \_\_\_\_\_  
ii. Source(s) of description or evaluation: \_\_\_\_\_  
iii. Extent of community/habitat:  
• Currently: \_\_\_\_\_ acres  
• Following completion of project as proposed: \_\_\_\_\_ acres  
• Gain or loss (indicate + or -): \_\_\_\_\_ acres

---

o. Does project site contain any species of plant or animal that is listed by the federal government or NYS as endangered or threatened, or does it contain any areas identified as habitat for an endangered or threatened species?  Yes  No  
(EAF Mapper automated response)  
If Yes:  
i. Species and listing (endangered or threatened): \_\_\_\_\_  
Indiana Bat, northern long-eared bat, bog turtle, dwarf wedgemussel, and small whorled pogonia. Refer to FEAF Narrative Section 9.0.  
\_\_\_\_\_

---

p. Does the project site contain any species of plant or animal that is listed by NYS as rare, or as a species of special concern?  Yes  No  
(EAF Mapper automated response)  
If Yes:  
i. Species and listing: \_\_\_\_\_  
\_\_\_\_\_

---

q. Is the project site or adjoining area currently used for hunting, trapping, fishing or shell fishing?  Yes  No  
If yes, give a brief description of how the proposed action may affect that use: \_\_\_\_\_  
\_\_\_\_\_

---

**E.3. Designated Public Resources On or Near Project Site**

a. Is the project site, or any portion of it, located in a designated agricultural district certified pursuant to Agriculture and Markets Law, Article 25-AA, Section 303 and 304?  Yes  No  
(EAF Mapper automated response)  
If Yes, provide county plus district name/number: \_\_\_\_\_

b. Are agricultural lands consisting of highly productive soils present?  Yes  No  
i. If Yes: acreage(s) on project site? \_\_\_\_\_  
ii. Source(s) of soil rating(s): \_\_\_\_\_

c. Does the project site contain all or part of, or is it substantially contiguous to, a registered National Natural Landmark?  Yes  No  
(EAF Mapper automated response)  
If Yes:  
i. Nature of the natural landmark:  Biological Community  Geological Feature  
ii. Provide brief description of landmark, including values behind designation and approximate size/extent: \_\_\_\_\_  
\_\_\_\_\_

d. Is the project site located in or does it adjoin a state listed Critical Environmental Area?  Yes  No  
(EAF Mapper automated response)  
If Yes:  
i. CEA name: \_\_\_\_\_  
ii. Basis for designation: \_\_\_\_\_  
iii. Designating agency and date: \_\_\_\_\_



e. Does the project site contain, or is it substantially contiguous to, a building, archaeological site, or district which is listed on the National or State Register of Historic Places, or that has been determined by the Commissioner of the NYS Office of Parks, Recreation and Historic Preservation to be eligible for listing on the State Register of Historic Places?  Yes  No  
 Refer to FEAF Narrative Section 10.0.

If Yes:  
 i. Nature of historic/archaeological resource:  Archaeological Site  Historic Building or District  
 ii. Name: \_\_\_\_\_  
 iii. Brief description of attributes on which listing is based: \_\_\_\_\_

f. Is the project site, or any portion of it, located in or adjacent to an area designated as sensitive for archaeological sites on the NY State Historic Preservation Office (SHPO) archaeological site inventory?  Yes  No  
 (EAF Mapper automated response)  
 Refer to FEAF Narrative Section 10.0.

g. Have additional archaeological or historic site(s) or resources been identified on the project site?  Yes  No  
 If Yes:  
 i. Describe possible resource(s): \_\_\_\_\_  
 ii. Basis for identification: \_\_\_\_\_

h. Is the project site within five miles of any officially designated and publicly accessible federal, state, or local scenic or aesthetic resource?  Yes  No  
 If Yes:  
 i. Identify resource: Refer to Figure 9.  
 ii. Nature of, or basis for, designation (e.g., established highway overlook, state or local park, state historic trail or scenic byway, etc.): NYS Scenic Byway; DEC trails; SASS; State parks, recreation, forest; State/National Historic Register site; County & municipal recreation  
 iii. Distance between project and resource: \_\_\_\_\_ 0.5+/- miles. (Echo Lawn Estate)

i. Is the project site located within a designated river corridor under the Wild, Scenic and Recreational Rivers Program 6 NYCRR 666?  Yes  No  
 (EAF Mapper automated response)  
 If Yes:  
 i. Identify the name of the river and its designation: \_\_\_\_\_  
 ii. Is the activity consistent with development restrictions contained in 6NYCRR Part 666?  Yes  No

**F. Additional Information**

Attach any additional information which may be needed to clarify your project.

If you have identified any adverse impacts which could be associated with your proposal, please describe those impacts plus any measures which you propose to avoid or minimize them.

**G. Verification**

I certify that the information provided is true to the best of my knowledge.

Applicant/Sponsor Name Gas Land Petroleum, Inc. Date 7/27/2021

Signature  Title Senior Planner, Chazen Companies, Agent for App.

Caren LoBrutto

**PRINT FORM**

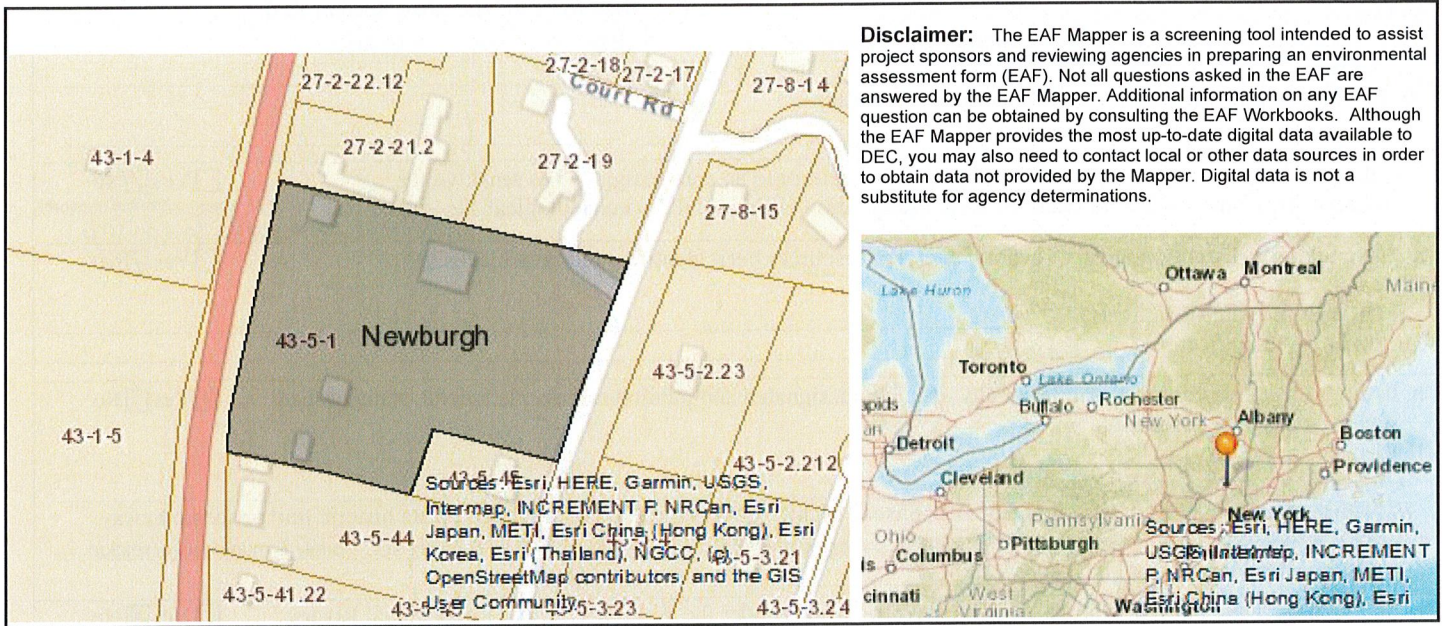

B.i.i [Coastal or Waterfront Area]	Yes
B.i.ii [Local Waterfront Revitalization Area]	No
C.2.b. [Special Planning District]	Digital mapping data are not available or are incomplete. Refer to EAF Workbook.
E.1.h [DEC Spills or Remediation Site - Potential Contamination History]	Digital mapping data are not available or are incomplete. Refer to EAF Workbook.
E.1.h.i [DEC Spills or Remediation Site - Listed]	Digital mapping data are not available or are incomplete. Refer to EAF Workbook.
E.1.h.i [DEC Spills or Remediation Site - Environmental Site Remediation Database]	Digital mapping data are not available or are incomplete. Refer to EAF Workbook.
E.1.h.iii [Within 2,000' of DEC Remediation Site]	No
E.2.g [Unique Geologic Features]	No
E.2.h.i [Surface Water Features]	Yes
E.2.h.ii [Surface Water Features]	Yes
E.2.h.iii [Surface Water Features]	Yes - Digital mapping information on local and federal wetlands and waterbodies is known to be incomplete. Refer to EAF Workbook.
E.2.h.iv [Surface Water Features - Stream Name]	862-360
E.2.h.iv [Surface Water Features - Stream Classification]	C
E.2.h.iv [Surface Water Features - Wetlands Name]	Federal Waters
E.2.h.v [Impaired Water Bodies]	No
E.2.i. [Floodway]	No
E.2.j. [100 Year Floodplain]	No
E.2.k. [500 Year Floodplain]	No

E.2.i. [Aquifers]	No
E.2.n. [Natural Communities]	No
E.2.o. [Endangered or Threatened Species]	Yes
E.2.o. [Endangered or Threatened Species - Name]	Indiana Bat
E.2.p. [Rare Plants or Animals]	No
E.3.a. [Agricultural District]	No
E.3.c. [National Natural Landmark]	No
E.3.d [Critical Environmental Area]	No
E.3.e. [National or State Register of Historic Places or State Eligible Sites]	Digital mapping data are not available or are incomplete. Refer to EAF Workbook.
E.3.f. [Archeological Sites]	No
E.3.i. [Designated River Corridor]	No



## FIGURES

---



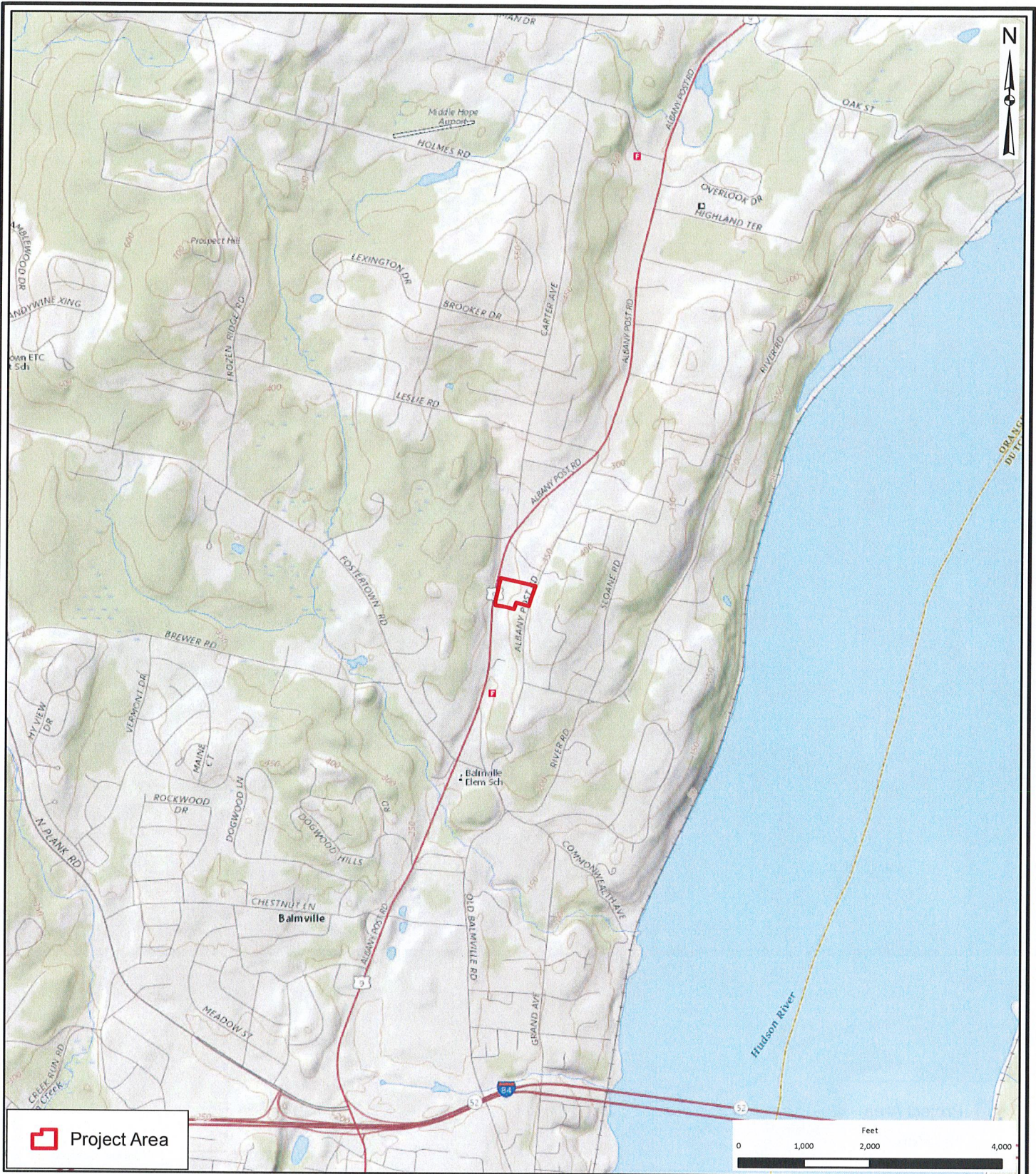

 Project Area

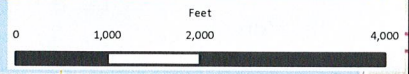

**THE Chazen COMPANIES**  
ENGINEERS  
 LAND SURVEYORS  
 PLANNERS  
 ENVIRONMENTAL & SAFETY PROFESSIONALS  
 LANDSCAPE ARCHITECTS

**Dutchess County Office:**  
 21 Fox Street, Poughkeepsie, NY 12601  
 Phone: (845) 454-3980

**Capital District Office:**  
 547 River Street, Troy, NY 12180  
 Phone: (518) 273-0055

**North Country Office:**  
 20 Elm St, Suite 110  
 Glens Falls, NY 12801  
 Phone: (518) 812-0513



**Gas Land Petroleum, Inc.**

**USGS Location Map**

5200 Route 9W, Town of Newburgh - Orange County NY

Drawn:	RL-B
Date:	06/04/2019
Scale:	1 in = 2,000 feet
Project:	81912.00
Figure:	1



 Project Area  
 Tax Parcels

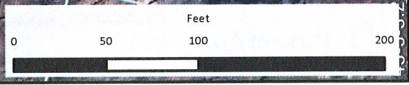

**THE Chazen COMPANIES**  
ENGINEERS  
LAND SURVEYORS  
PLANNERS  
ENVIRONMENTAL & SAFETY PROFESSIONALS  
LANDSCAPE ARCHITECTS

**Dutchess County Office:**  
 21 Fox Street, Poughkeepsie, NY 12601  
 Phone: (845) 454-3980

**Capital District Office:**  
 547 River Street, Troy, NY 12180  
 Phone: (518) 273-0055

**North Country Office:**  
 20 Elm St, Suite 110  
 Glens Falls, NY 12801  
 Phone: (518) 812-0513

**Gas Land Petroleum, Inc.**

**Orthophoto Tax Map**

5200 Route 9W, Town of Newburgh - Orange County NY

Drawn:	RL-B
Date:	06/04/2019
Scale:	1 in = 100 feet
Project:	81912.00
Figure:	2



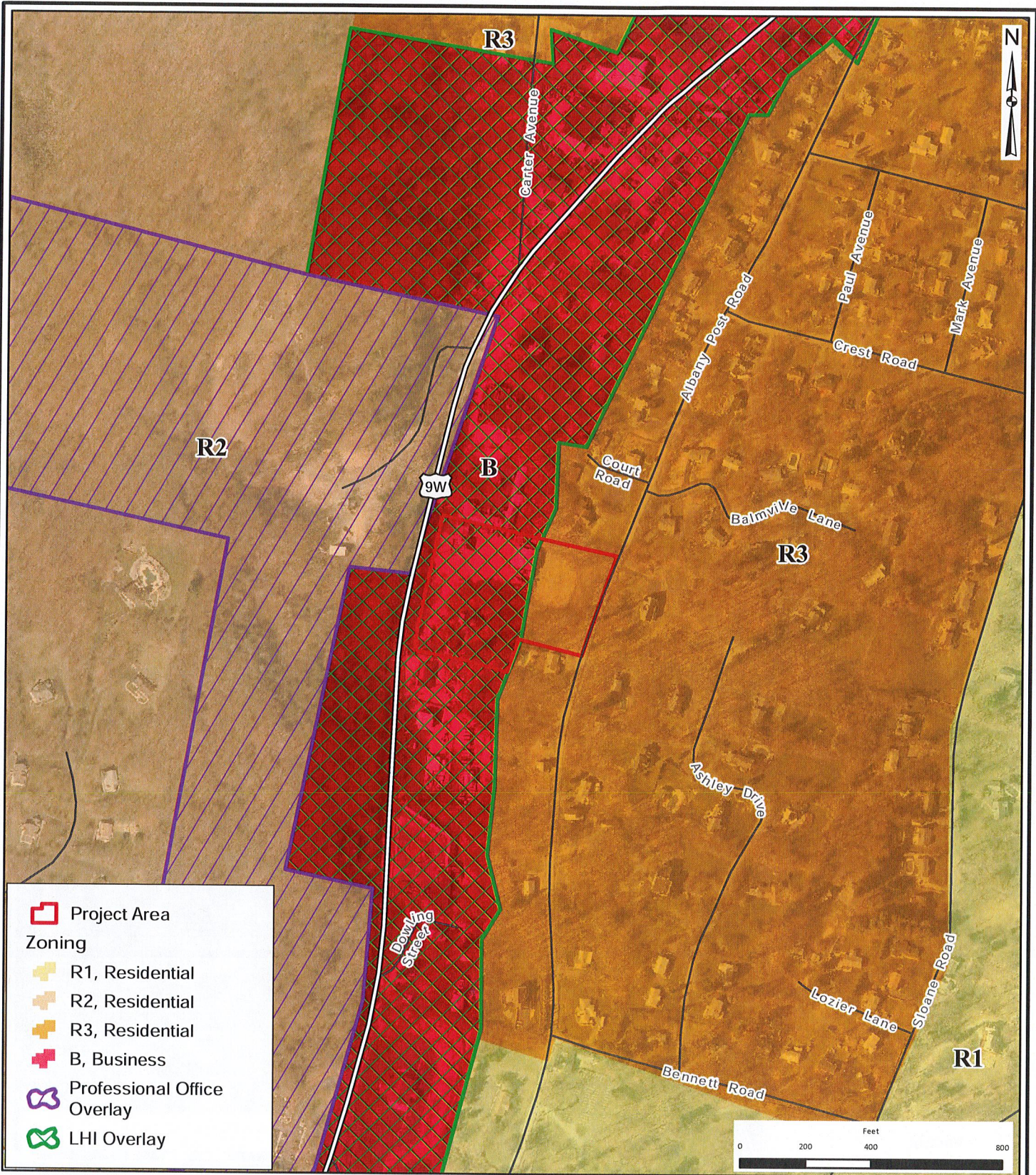

- Project Area
- Zoning**
- R1, Residential
- R2, Residential
- R3, Residential
- B, Business
- Professional Office Overlay
- LHI Overlay

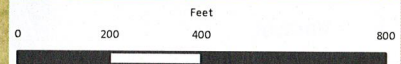

*Dutchess County Office:*  
 21 Fox Street, Poughkeepsie, NY 12601  
 Phone: (845) 454-3980

*Capital District Office:*  
 547 River Street, Troy, NY 12180  
 Phone: (518) 273-0055

*North Country Office:*  
 20 Elm St, Suite 110  
 Glens Falls, NY 12801  
 Phone: (518) 812-0513







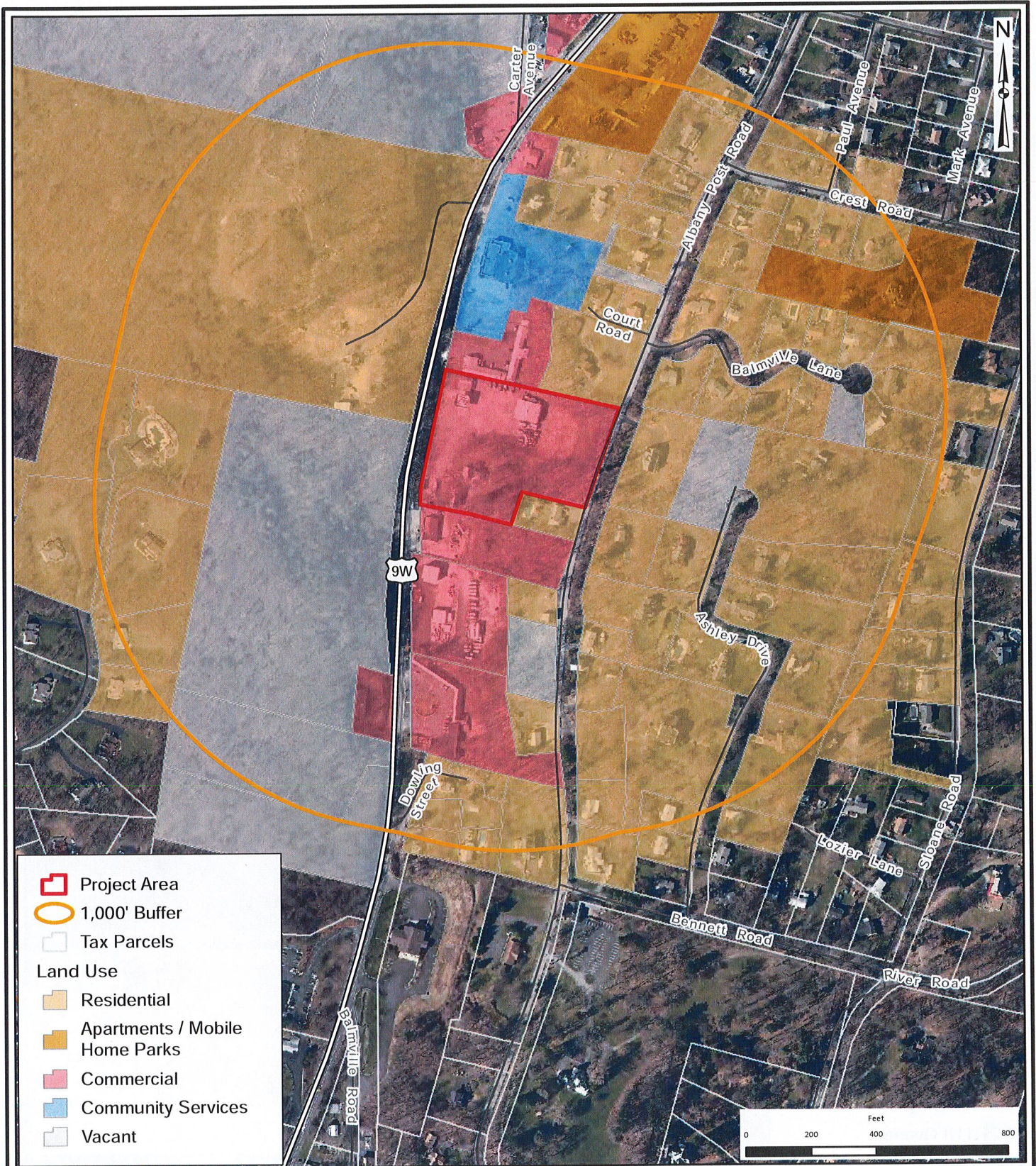

**Gas Land Petroleum, Inc.**

**Zoning**

5200 Route 9W, Town of Newburgh - Orange County NY

Drawn:	RL-B
Date:	06/04/2019
Scale:	1 in = 400 feet
Project:	81912.00
Figure:	3



 Project Area  
 1,000' Buffer  
 Tax Parcels  
**Land Use**  
 Residential  
 Apartments / Mobile Home Parks  
 Commercial  
 Community Services  
 Vacant

**THE Chazen COMPANIES**  
ENGINEERS  
LAND SURVEYORS  
PLANNERS  
ENVIRONMENTAL & SAFETY PROFESSIONALS  
LANDSCAPE ARCHITECTS  
 Dutchess County Office:  
 21 Fox Street, Poughkeepsie, NY 12601  
 Phone: (845) 454-3980  
 Capital District Office:  
 547 River Street, Troy, NY 12180  
 Phone: (518) 273-0055  
 North Country Office:  
 20 Elm St, Suite 110  
 Glens Falls, NY 12801  
 Phone: (518) 812-0513

**Gas Land Petroleum, Inc.**  
  
**Land Use**  
  
 5200 Route 9W, Town of Newburgh - Orange County NY

Drawn:	RL-B
Date:	06/04/2019
Scale:	1 in = 400 feet
Project:	81912.00
Figure:	4

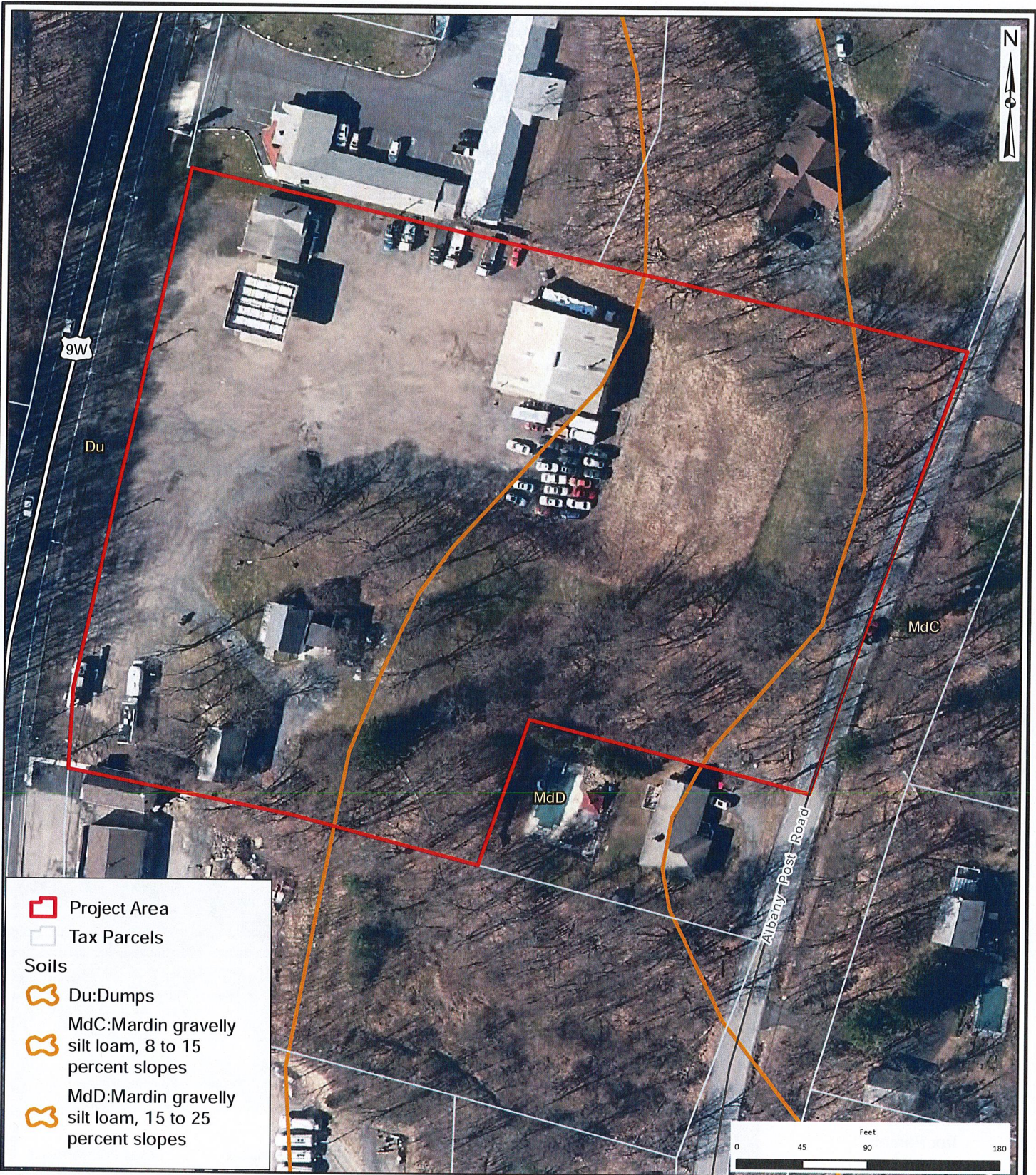

Project Area

Tax Parcels

**Soils**

Du:Dumps

MdC:Mardin gravelly silt loam, 8 to 15 percent slopes

MdD:Mardin gravelly silt loam, 15 to 25 percent slopes

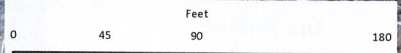

Dutchess County Office:  
21 Fox Street, Poughkeepsie, NY 12601  
Phone: (845) 454-3980

Capital District Office:  
547 River Street, Troy, NY 12180  
Phone: (518) 273-0055

North Country Office:  
20 Elm St, Suite 110  
Glens Falls, NY 12801  
Phone: (518) 812-0513

ENGINEERS  
LAND SURVEYORS  
PLANNERS  
ENVIRONMENTAL & SAFETY PROFESSIONALS  
LANDSCAPE ARCHITECTS





**Gas Land Petroleum, Inc.**

**Soils**

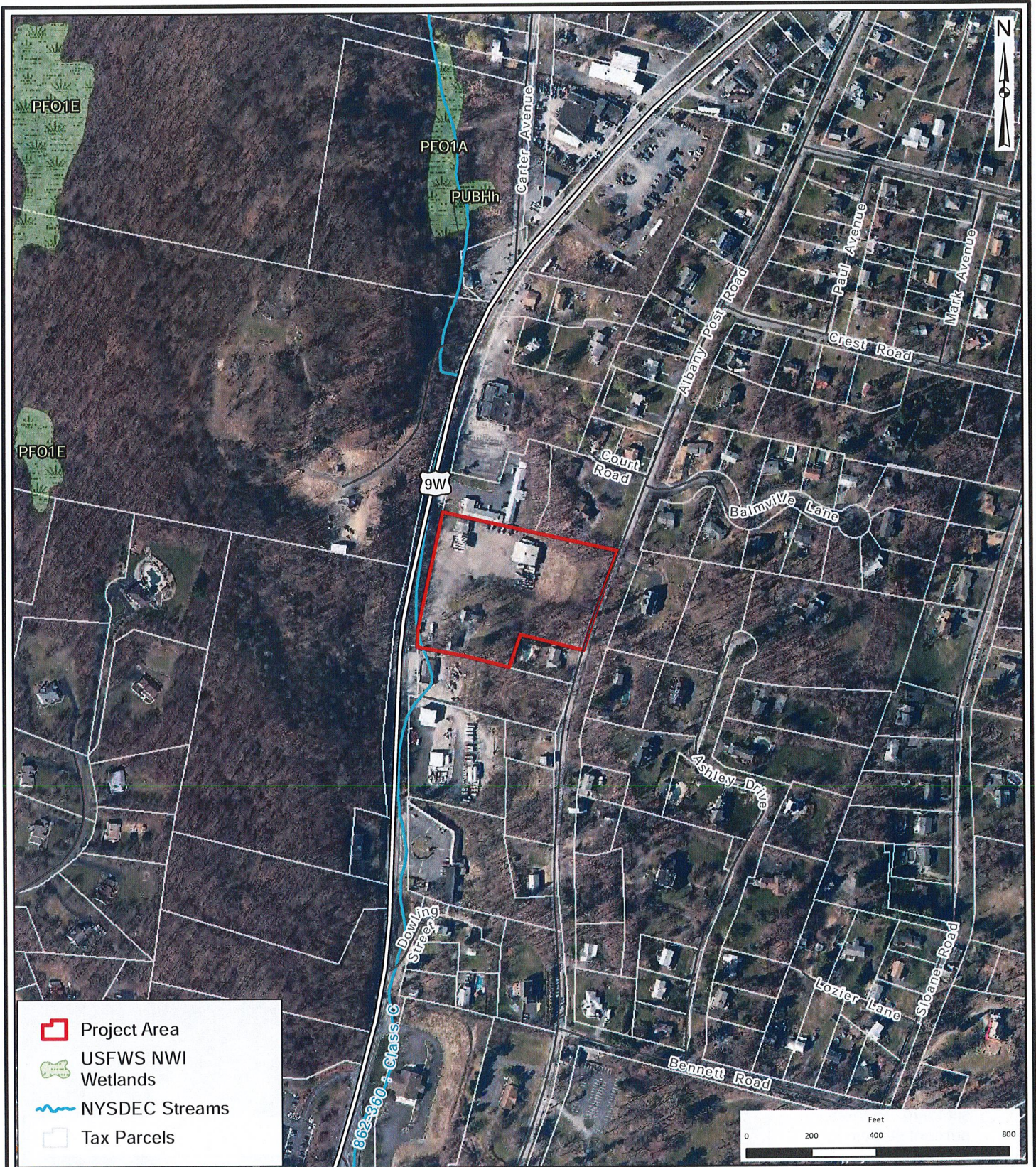
5200 Route 9W, Town of Newburgh - Orange County NY

Drawn:	RL-B
Date:	06/04/2019
Scale:	1 in = 90 feet
Project:	81912.00
Figure:	5



-  Project Area
-  USFWS NWI Wetlands
-  NYSDEC Streams
-  Tax Parcels

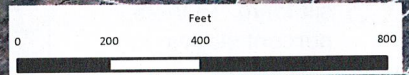

**THE Chazen COMPANIES**  
ENGINEERS  
 LAND SURVEYORS  
 PLANNERS  
 ENVIRONMENTAL & SAFETY PROFESSIONALS  
 LANDSCAPE ARCHITECTS

*Dutchess County Office:*  
 21 Fox Street, Poughkeepsie, NY 12601  
 Phone: (845) 454-3980

*Capital District Office:*  
 547 River Street, Troy, NY 12180  
 Phone: (518) 273-0055

*North Country Office:*  
 20 Elm St, Suite 110  
 Glens Falls, NY 12801  
 Phone: (518) 812-0513

**Gas Land Petroleum, Inc.**

**Wetlands, Streams and Floodplains**

5200 Route 9W, Town of Newburgh - Orange County NY

Drawn:	RL-B
Date:	06/04/2019
Scale:	1 in = 400 feet
Project:	81912.00
Figure:	6

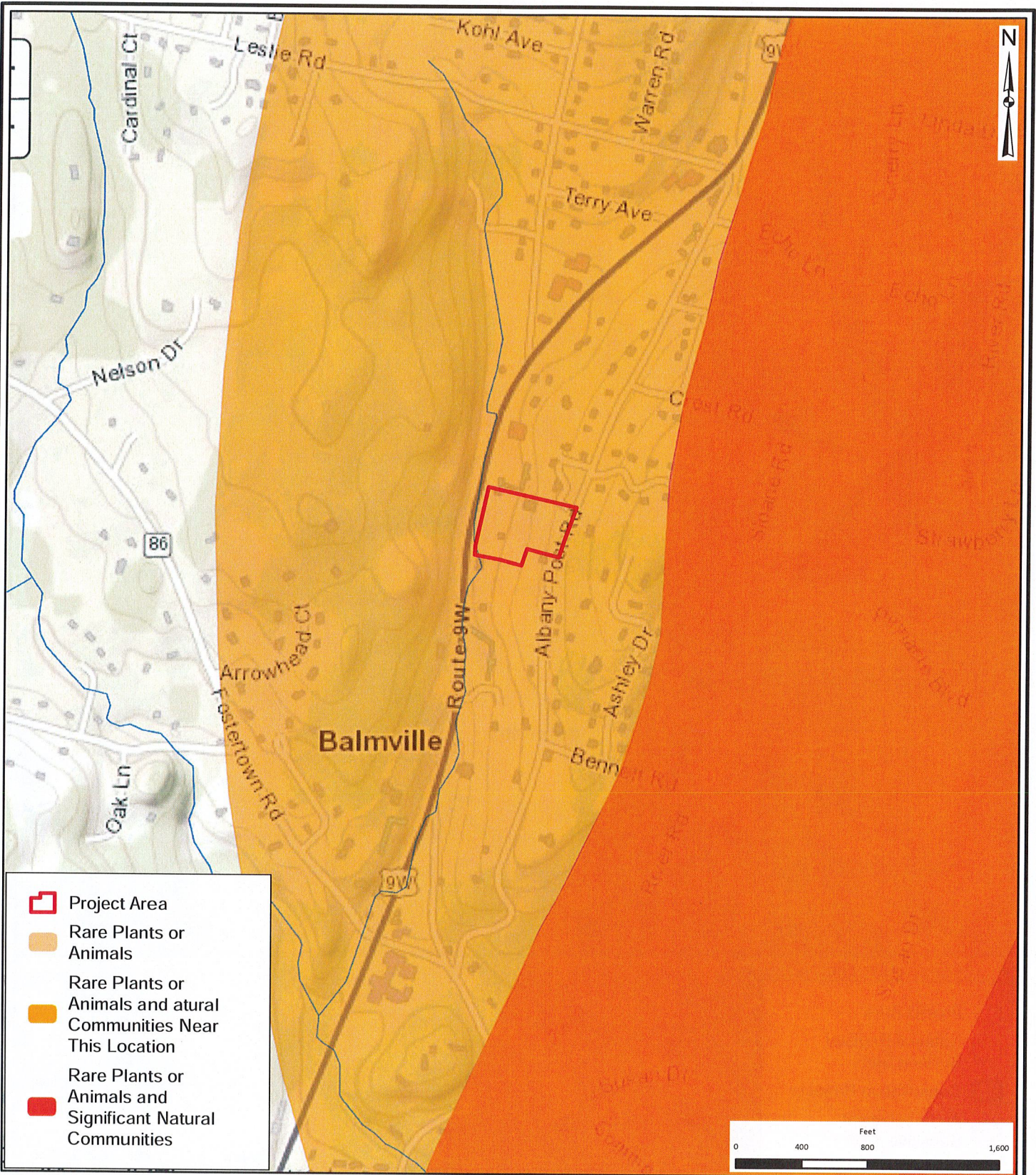

**Project Area**

**Rare Plants or Animals**

**Rare Plants or Animals and atural Communities Near This Location**

**Rare Plants or Animals and Significant Natural Communities**

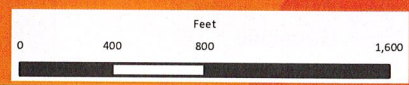

**THE Chazen COMPANIES**  
ENGINEERS  
LAND SURVEYORS  
PLANNERS  
ENVIRONMENTAL & SAFETY PROFESSIONALS  
LANDSCAPE ARCHITECTS

*Dutchess County Office:*  
21 Fox Street, Poughkeepsie, NY 12601  
Phone: (845) 454-3980

*Capital District Office:*  
547 River Street, Troy, NY 12180  
Phone: (518) 273-0055

*North Country Office:*  
20 Elm St, Suite 110  
Glens Falls, NY 12801  
Phone: (518) 812-0513

**Gas Land Petroleum, Inc.**

**NYSDEC Environmental Resource Map**

5200 Route 9W, Town of Newburgh - Orange County NY

Drawn:	RL-B
Date:	06/04/2019
Scale:	1 in = 800 feet
Project:	81912.00
Figure:	7



THE  
**Chazen**  
COMPANIES

ENGINEERS  
LAND SURVEYORS  
PLANNERS  
ENVIRONMENTAL & SAFETY PROFESSIONALS  
LANDSCAPE ARCHITECTS

Dutchess County Office:  
21 Fox Street, Poughkeepsie, NY 12601  
Phone: (845) 454-3980

Capital District Office:  
547 River Street, Troy, NY 12180  
Phone: (518) 273-0055

North Country Office:  
20 Elm St, Suite 110  
Glens Falls, NY 12801  
Phone: (518) 812-0513

Gas Land Petroleum, Inc.

NYSOPRHP Cultural Resource Information  
System (CRIS) Map

5200 Route 9W, Town of Newburgh - Orange County NY

Drawn:	RL-B
Date:	06/04/2019
Scale:	1 in = 1,000 feet
Project:	81912.00
Figure:	8

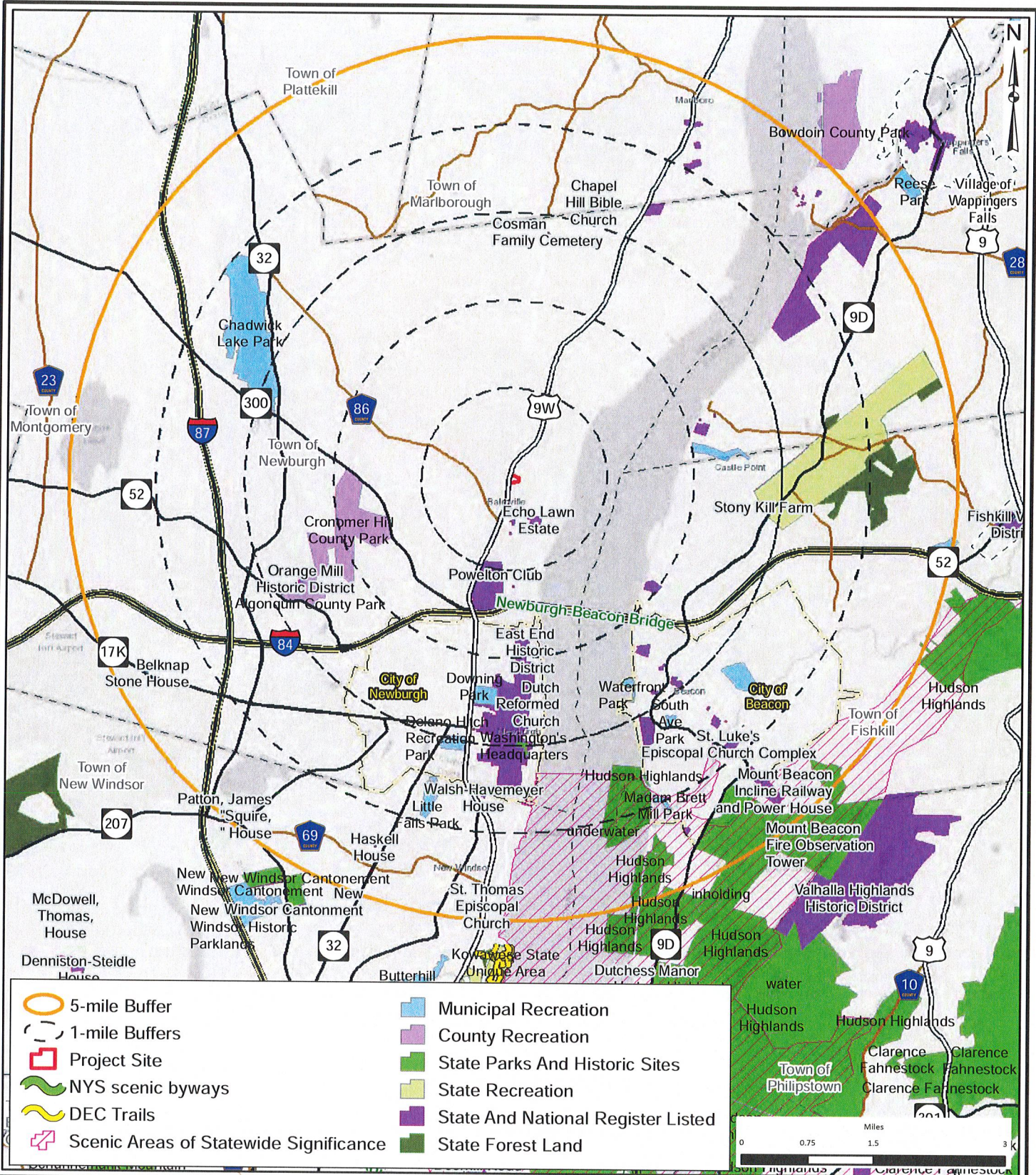

**THE Chazen COMPANIES**  
 ENGINEERS  
 LAND SURVEYORS  
 PLANNERS  
 ENVIRONMENTAL & SAFETY PROFESSIONALS  
 LANDSCAPE ARCHITECTS

**Dutchess County Office:**  
 21 Fox Street, Poughkeepsie, NY 12601  
 Phone: (845) 454-3980

**Capital District Office:**  
 547 River Street, Troy, NY 12180  
 Phone: (518) 273-0055

**North Country Office:**  
 20 Elm St, Suite 110  
 Glens Falls, NY 12801  
 Phone: (518) 812-0513

*Gas Land Petroleum, Inc.*

**Publicly Accessible  
 Federal, State, or Local Scenic or Aesthetic  
 Resources within 5 Miles**

5200 Route 9W, Town of Newburgh - Orange County NY

Drawn:	RL-B
Date:	06/04/2019
Scale:	1 in = 1.5 miles
Project:	81912.00
Figure:	9





**ATTACHMENT A**  
**Endangered and Threatened Species Information**

---



## NEW YORK STATE DEPARTMENT OF ENVIRONMENTAL CONSERVATION

Division of Fish and Wildlife, New York Natural Heritage Program  
625 Broadway, Fifth Floor, Albany, NY 12233-4757  
P: (518) 402-8935 | F: (518) 402-8925  
www.dec.ny.gov

July 22, 2019

Deborah Hubbard  
The Chazen Companies  
21 Fox Street  
Poughkeepsie, NY 12601

Re: Gas Land Petroleum - proposed gasoline station/convenience store at 5200 Route 9W  
County: Orange Town/City: Newburgh

Dear Ms. Hubbard:

In response to your recent request, we have reviewed the New York Natural Heritage Program database with respect to the above project.

We have no records of rare or state-listed animals or plants, or significant natural communities at the project site or in its immediate vicinity.

Within 2.5 miles of the project site are several documented maternity colonies of **Indiana bat** (*Myotis sodalis*, state and federally listed as Endangered). These bats may travel 2.5 miles or more from documented locations. The main impact of concern for bats is the cutting or removal of potential roost trees. For information about any permit considerations for your project, please contact the Permits staff at the NYSDEC Region 3 Office at [dep.r3@dec.ny.gov](mailto:dep.r3@dec.ny.gov), (845) 256-3054.

For most sites, comprehensive field surveys have not been conducted. We cannot provide a definitive statement on the presence or absence of all rare or state-listed species or significant natural communities. Depending on the nature of the project and the conditions at the project site, further information from on-site surveys or other resources may be required to fully assess impacts on biological resources.

For information regarding other permits that may be required under state law for regulated areas or activities (e.g., regulated wetlands), please contact the Permits staff at the NYSDEC Region 3 Office as described above.

Sincerely,



Heidi Kraehling  
Environmental Review Specialist  
New York Natural Heritage Program



## United States Department of the Interior

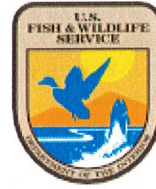

FISH AND WILDLIFE SERVICE  
New York Ecological Services Field Office  
3817 Luker Road  
Cortland, NY 13045-9385  
Phone: (607) 753-9334 Fax: (607) 753-9699  
<http://www.fws.gov/northeast/nyfo/es/section7.htm>

In Reply Refer To:

June 05, 2019

Consultation Code: 05E1NY00-2019-SLI-2207

Event Code: 05E1NY00-2019-E-06889

Project Name: 2-Lot Subdivision and Proposed Gas Station/Convenience Store on Proposed Lot 1

Subject: List of threatened and endangered species that may occur in your proposed project location, and/or may be affected by your proposed project

To Whom It May Concern:

The enclosed species list identifies threatened, endangered, proposed and candidate species, as well as proposed and final designated critical habitat, that may occur within the boundary of your proposed project and/or may be affected by your proposed project. The species list fulfills the requirements of the U.S. Fish and Wildlife Service (Service) under section 7(c) of the Endangered Species Act (ESA) of 1973, as amended (16 U.S.C. 1531 *et seq.*). This list can also be used to determine whether listed species may be present for projects without federal agency involvement. New information based on updated surveys, changes in the abundance and distribution of species, changed habitat conditions, or other factors could change this list.

Please feel free to contact us if you need more current information or assistance regarding the potential impacts to federally proposed, listed, and candidate species and federally designated and proposed critical habitat. Please note that under 50 CFR 402.12(e) of the regulations implementing section 7 of the ESA, the accuracy of this species list should be verified after 90 days. This verification can be completed formally or informally as desired. The Service recommends that verification be completed by visiting the ECOS-IPaC site at regular intervals during project planning and implementation for updates to species lists and information. An updated list may be requested through the ECOS-IPaC system by completing the same process used to receive the enclosed list. If listed, proposed, or candidate species were identified as potentially occurring in the project area, coordination with our office is encouraged. Information on the steps involved with assessing potential impacts from projects can be found at: <http://www.fws.gov/northeast/nyfo/es/section7.htm>

Please be aware that bald and golden eagles are protected under the Bald and Golden Eagle Protection Act (16 U.S.C. 668 *et seq.*), and projects affecting these species may require development of an eagle conservation plan ([http://www.fws.gov/windenergy/eagle\\_guidance.html](http://www.fws.gov/windenergy/eagle_guidance.html)). Additionally, wind energy projects should follow the Services wind energy guidelines (<http://www.fws.gov/windenergy/>) for minimizing impacts to migratory birds and bats.

Guidance for minimizing impacts to migratory birds for projects including communications towers (e.g., cellular, digital television, radio, and emergency broadcast) can be found at: <http://www.fws.gov/migratorybirds/CurrentBirdIssues/Hazards/towers/towers.htm>; <http://www.towerkill.com>; and <http://www.fws.gov/migratorybirds/CurrentBirdIssues/Hazards/towers/comtow.html>.

We appreciate your concern for threatened and endangered species. The Service encourages Federal agencies to include conservation of threatened and endangered species into their project planning to further the purposes of the ESA. Please include the Consultation Tracking Number in the header of this letter with any request for consultation or correspondence about your project that you submit to our office.

Attachment(s):

- Official Species List

## Official Species List

This list is provided pursuant to Section 7 of the Endangered Species Act, and fulfills the requirement for Federal agencies to "request of the Secretary of the Interior information whether any species which is listed or proposed to be listed may be present in the area of a proposed action".

This species list is provided by:

**New York Ecological Services Field Office**

3817 Luker Road

Cortland, NY 13045-9385

(607) 753-9334

## Project Summary

Consultation Code: 05E1NY00-2019-SLI-2207

Event Code: 05E1NY00-2019-E-06889

Project Name: 2-Lot Subdivision and Proposed Gas Station/Convenience Store on Proposed Lot 1

Project Type: DEVELOPMENT

Project Description: Proposed 2-lot subdivision of a 4.5 acre parcel to provide a separate parcel for a new gas station/convenience store with associated parking. The project includes connection of both proposed parcels to municipal water service, a new subsurface sewage disposal system, and access improvements.

Project Location:

Approximate location of the project can be viewed in Google Maps: <https://www.google.com/maps/place/41.54167842007176N74.01164606963746W>

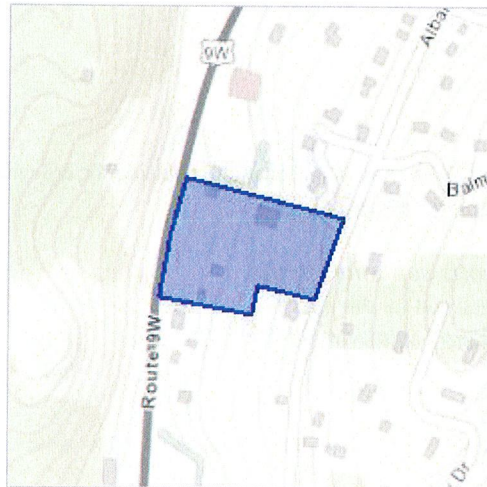

Counties: Orange, NY

## Endangered Species Act Species

There is a total of 5 threatened, endangered, or candidate species on this species list.

Species on this list should be considered in an effects analysis for your project and could include species that exist in another geographic area. For example, certain fish may appear on the species list because a project could affect downstream species.

IPaC does not display listed species or critical habitats under the sole jurisdiction of NOAA Fisheries<sup>1</sup>, as USFWS does not have the authority to speak on behalf of NOAA and the Department of Commerce.

See the "Critical habitats" section below for those critical habitats that lie wholly or partially within your project area under this office's jurisdiction. Please contact the designated FWS office if you have questions.

- 
1. [NOAA Fisheries](#), also known as the National Marine Fisheries Service (NMFS), is an office of the National Oceanic and Atmospheric Administration within the Department of Commerce.

### Mammals

NAME	STATUS
Indiana Bat <i>Myotis sodalis</i> There is <b>final</b> critical habitat for this species. Your location is outside the critical habitat. Species profile: <a href="https://ecos.fws.gov/ecp/species/5949">https://ecos.fws.gov/ecp/species/5949</a>	Endangered
Northern Long-eared Bat <i>Myotis septentrionalis</i> No critical habitat has been designated for this species. Species profile: <a href="https://ecos.fws.gov/ecp/species/9045">https://ecos.fws.gov/ecp/species/9045</a>	Threatened

### Reptiles

NAME	STATUS
Bog Turtle <i>Clemmys muhlenbergii</i> Population: Wherever found, except GA, NC, SC, TN, VA No critical habitat has been designated for this species. Species profile: <a href="https://ecos.fws.gov/ecp/species/6962">https://ecos.fws.gov/ecp/species/6962</a> Species survey guidelines: <a href="https://ecos.fws.gov/ipac/guideline/survey/population/182/office/52410.pdf">https://ecos.fws.gov/ipac/guideline/survey/population/182/office/52410.pdf</a> Habitat assessment guidelines: <a href="https://ecos.fws.gov/ipac/guideline/assessment/population/182/office/52410.pdf">https://ecos.fws.gov/ipac/guideline/assessment/population/182/office/52410.pdf</a>	Threatened

---



## Clams

NAME	STATUS
Dwarf Wedgemussel <i>Alasmidonta heterodon</i> No critical habitat has been designated for this species. Species profile: <a href="https://ecos.fws.gov/ecp/species/784">https://ecos.fws.gov/ecp/species/784</a> Species survey guidelines: <a href="https://ecos.fws.gov/ipac/guideline/survey/population/363/office/52410.pdf">https://ecos.fws.gov/ipac/guideline/survey/population/363/office/52410.pdf</a>	Endangered

## Flowering Plants

NAME	STATUS
Small Whorled Pogonia <i>Isotria medeoloides</i> No critical habitat has been designated for this species. Species profile: <a href="https://ecos.fws.gov/ecp/species/1890">https://ecos.fws.gov/ecp/species/1890</a> Species survey guidelines: <a href="https://ecos.fws.gov/ipac/guideline/survey/population/742/office/52410.pdf">https://ecos.fws.gov/ipac/guideline/survey/population/742/office/52410.pdf</a>	Threatened

## Critical habitats

THERE ARE NO CRITICAL HABITATS WITHIN YOUR PROJECT AREA UNDER THIS OFFICE'S JURISDICTION.



**ATTACHMENT B**  
**Pat's Towing Letter Describing Future Operations**

---





## TOWING FOR LOCAL & STATE MUNICIPALITIES

(845) 561-4004 (Phone)  
(845) 568-3012 (Fax)  
5198 Route 9W Newburgh, NY 12550

*JAN. 31 2020*  
~~August 12, 2019~~

Town of Newburgh Planning Board

Mr. John Ewasutyn, Chairman:

The purpose of this letter is to clarify the future plans for the Route 9W site, now occupied by Pat's Towing. As presented to the board, Gas Land Petroleum Inc. is under contract to develop a gasoline/diesel pumping facility along with a convenience store located on a portion of the land, known as #5198-5200 Route 9W. The board has requested clarification regarding the remaining lands beyond the subdivision/site plan presented.

Pat's Towing initially expressed their intention to Gas Land Petroleum, Inc. to use the repair garage, located in the rear of the lot on 9W, as their company vehicle maintenance facility only, with no other repairs or storage on the property. This was presented to the planning board on August 1, 2019.

After further consideration, given the fact they are an existing registered automotive repair facility, and an official New York State Inspection Station, Pat's now intends to retain the ability to repair a customer vehicle, should that business present itself. (A likely scenario as they tow in break downs, needing repairs.)

Operations at the 9W site will be reduced substantially. Approximately 6 tow trucks will be stationed at this location, primarily for local Town of Newburgh business. The fenced in yard, located in the rear of the property will be used to house these local Newburgh towed in vehicles. This gated section will be screened from public view, with privacy fence and added landscaping.

The intention of Pat's Towing is to remove 90% of the vehicles that are presently stored on site. These "impound" vehicles and "towed in" vehicles will be relocated to another property that is being acquired by the company, allowing them a more centralized location for their operation.

As per the contract between Gas Land and Pat's Towing, the sightlines running along Route 9W must be kept clear, thereby eliminating the parking of vehicles associated with Pat's Towing along the frontage on 9W.

We will identify the size and numbers of the Tow vehicles that will be stationed at this site on the plan map. Additionally, Pat's will need approximately 10 spaces outside the fenced in storage to accommodate customer's vehicles in for repairs, and employee parking, which will appear on the site plan.

Members of the ownership of Pat's Towing will be attending the next Planning Board meeting, as requested. They are committed to visual improvements of their property.

Sincerely,



Patrick Macioce  
John Macioce

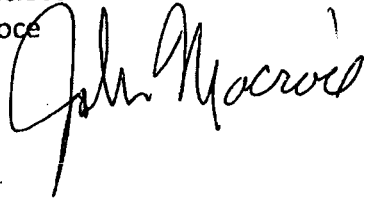

**ATTACHMENT C**  
**Typical Underground Petroleum**  
**Storage Tank Drawing**

---







# PETROLEUM STORAGE FIBERGLASS UNDERGROUND TANK SPECIFICATION

## SHORT FORM SPECIFICATION

The contractor shall provide the appropriate double or triple-wall fiberglass storage tank and accessories as indicated on tank drawings. Capacity, dimensions and fitting locations will be indicated on tank drawings. Tanks shall be manufactured by Containment Solutions, Inc. The tank must be tested and installed according to manufacturer's current installation instructions.

## LONG FORM SPECIFICATION

### 1. GENERAL

#### 1.1. Quality Assurance

##### 1.1.1. Acceptable Manufacturers:

Containment Solutions, Inc., Conroe, Texas

##### 1.1.2. Governing Standards, as applicable:

1.1.2.1. Underwriters Laboratories Inc. Standard 1316, Glass-Fiber Reinforced Plastic Underground Storage Tanks for Petroleum Products, Alcohols, and Alcohol-Gasoline Mixtures.

1.1.2.2. Underwriters Laboratories of Canada standard ULC-5615, Reinforced Plastic Underground Tanks for Flammable & Combustible Liquids.

##### 1.1.2.3. National Fire Protection Association codes and standards:

- NFPA 30 Flammable and Combustible Liquids Code
- NFPA 30A Motor Fuel Dispensing Facilities and Repair Garages Code
- NFPA 31 Installation of Oil-Burning Equipment Standard

1.1.2.4. City of New York Department of Buildings M.E.A., 71-85-M

1.1.2.5. American Concrete Institute standard ACI 318, Building Code Requirements for Structural Concrete.

#### 1.2. Submittals

1.2.1. Contractor shall submit \_\_\_\_ copies of: shop drawings, manufacturer's product brochures, installation instructions and calibration charts.

### 2. PRODUCTS

#### 2.1. Double-Wall and Triple-Wall

Fiberglass Underground Storage Tanks

##### 2.1.1. Loading Conditions - Tanks shall meet the following design criteria:

2.1.1.1. External hydrostatic pressure: Buried in ground with 7' of over burden over the top of the tank, the excavation fully flooded and a safety factor of 5:1 against general buckling.

2.1.1.2. Surface Loads: When installed according to manufacturer's current installation instructions, tanks shall withstand surface HS-20 axle loads (32,000 lbs/axle).

2.1.1.3. Internal Load: Primary and secondary tanks shall withstand 5 psig (35kPa), or 3 psig for 12' diameter tanks, air pressure test with 5:1 safety factor.

2.1.1.4. Tanks shall be designed to support accessory equipment such as heating coils, ladders, drop tubes, etc. when installed according to manufacturer's recommendations and limitations.

##### 2.1.2. Product-Storage Requirements

2.1.2.1. All primary tanks must be vented. Tanks are designed for operation at atmospheric pressure only, except for use with vapor recovery systems at a pressure or vacuum not to exceed 1 psig (7 kPa).

2.1.2.2. Tanks shall be capable of storing liquids with specific gravity up to 1.1.

2.1.2.3. Tank shall be capable of storing the following products:

- Diesel fuel oils for oil burning equipment at temperatures not to exceed 150°F.
- Gasoline, jet fuel, aviation gasoline, motor oil (new or used), kerosene, diesel motor fuel at ambient temperatures.
- Alcohol-gasoline blend motor fuels at ambient temperatures:
  - Gasoline-ethanol blends with up to 100% ethanol.
  - Gasoline-methanol blends with up to 100% methanol.
- Oxygenated motor fuels at ambient temperatures with up to 20% (by volume) methyl tertiary butyl ether (MTBE), ethyl tertiary butyl ether (ETBE), di-isopropyl ether (DIPE), tertiary butyl alcohol (TBA), tertiary amyl methyl ether (TAME), or tertiary amyl ethyl ether (TAEE).
- Biodiesel-diesel blends with up to 100% biodiesel (B100 per ASTM) at ambient temperatures.

### 2.1.3. Materials

- 2.1.3.1. The tank shall be manufactured as a matrix of premium resin, glass fibers and silane-treated silica that together result in a composite providing improved corrosion protection.
- 2.1.3.2. Tank inner wall shall be fabricated against a mold to produce a non-air inhibited and high gloss laminate to provide a fully cured inner surface without the need for wax coats, a low coefficient of friction and a natural resistance to the build-up of algae or other contamination on the surface. Wax and wax resin coatings cannot be used to achieve full surface cure on tank shells and endcaps.

### 2.1.4. Dimensional Requirements (refer to Containment Solutions literature)

- 2.1.4.1. Nominal capacity of the tank shall be \_\_\_\_ gallons / liters.
- 2.1.4.2. Nominal outside diameter of the tank shall be \_\_\_\_ feet.
- 2.1.4.3. Nominal overall length of the tank shall be \_\_\_\_ feet.

### 2.1.5. Monitoring Capabilities

- 2.1.5.1. Double and triple-wall tanks shall have a monitoring space between the walls to allow for the free flow and containment of leaked product from the primary tank. The monitoring space shall provide equal communication in all directions.
- 2.1.5.2. The following continuous monitoring conditions shall be compatible with the cavity between the inner and outer tanks:
  - Vented to atmosphere
  - Vacuum – 5 psig maximum
  - Positive air pressure (3 psig maximum)
  - External hydrostatic pressure – 7' maximum groundwater head pressure over tank top
- 2.1.5.3. Tanks 6' diameter and larger shall have an integrally mounted annular space reservoir installed on the tank for factory-installed brine and continuous hydrostatic monitoring. The reservoir shall be constructed of fiberglass reinforced plastic materials and be included in the tank warranty.
- 2.1.5.4. The monitoring fitting for the monitoring space shall be a 4" NPT fitting.
- 2.1.5.5. The monitoring system shall be capable of detecting a breach in the inner and outer tank under the following installed conditions:
  - When the primary tank is empty.
  - When the primary tank is partially or completely full and the ground water table is below tank bottom.
  - When the primary tank is partially or completely full and the tank is partially or completely submerged in groundwater.
- 2.1.5.6. The leak detection performance of the monitoring system shall be listed as a continuous interstitial monitoring method (liquid filled) by the National Work Group on Leak Detection Evaluations (NWGLDE). The system should be capable of detecting leaks in the primary or secondary tank walls as small as 0.10 gallons per hour within one-month.
- 2.1.5.7. The hydrostatic monitoring system shall be capable of a precision tank test that is listed by the National Work Group on Leak Detection Evaluations (NWGLDE).
- 2.1.5.8. If hydrostatically monitored, any solution used in the monitoring space shall be compatible with the tank and be of a contrasting color to the tank.

## 2.2. Accessories

### 2.2.1. Flanged Manways

- 2.2.1.1. The standard manway is 22" I.D. and will be furnished with UL listed gaskets and covers (30" and 36" manways are optional).
- 2.2.1.2. Location – see standard tank drawings.
- 2.2.1.3. Optional manway extensions shall be fiberglass and \_\_\_\_ feet long.

### 2.2.2. Fill Tubes - Fill tubes of appropriate design shall be supplied by contractor.

### 2.2.3. Hydrostatic Monitor Accessories

- 2.2.3.1. Brine monitoring fluid shall be a calcium chloride solution.
- 2.2.3.2. Double float reservoir sensor supplied by contractor shall be designed for CSI reservoirs. The components of the sensor shall be compatible with brine and provide two alarm points positioned 10" apart.

### 2.2.4. Secondary Containment Collar

- 2.2.4.1. UL label shall be affixed to collar.
- 2.2.4.2. The collar shall be fiberglass reinforced plastic, 42" or 48" in diameter and shall be factory-installed in accordance with drawings.
- 2.2.4.3. The collar shall include an internal adhesive channel.
- 2.2.4.4. The collar shall be included in the 30-year tank warranty.

### 2.2.5. Adhesive Kit (Kit AD)

- 2.2.5.1. UL Listed and alcohol compatible adhesive kit shall provide a watertight seal at the tank sump and containment collar joint to prevent the ingress of water or egress of fuel. The adhesive kit includes resin, catalyst, mixing stick, putty knife, sandpaper, grout bag, and installation instructions.

#### 2.2.6. Tank Sumps

- 2.2.6.1. UL label shall be affixed to tank sump components.
- 2.2.6.2. Tank sumps & collars shall be listed by Underwriters Laboratories for petroleum fuels and all blends of alcohol (same as tank). Collar and sump shall be tested and listed as a complete sump system.
- 2.2.6.3. Tank sump components shall be constructed of fiberglass reinforced plastic. The tank sump shall be 42" or 48" in diameter and must mount to the secondary containment collar. Standard tank sump shall consist of an octagon shaped base (round base is optional), round body extension and enclosure top.
- 2.2.6.4. The octagon base shall be 24" in height and provide 19" high panels for piping entry points. The base must be capable of joining to the collar with an internal adhesive channel.
- 2.2.6.5. A 34" O.D. watertight lid shall be provided at the submersible and fill/vapor end of the tank and provide a watertight seal to the sump enclosure with 12" of water above the lid and remain leak free.
- 2.2.6.6. Refer to tank sump drawings for standard models and configurations.

#### 2.2.7. Ladders

- 2.2.7.1. Ladders shall be supplied by the tank manufacturer (carbon steel, stainless steel, aluminum).

#### 2.2.8. Anchor Straps

- 2.2.8.1. Straps shall be supplied by the tank manufacturer.
- 2.2.8.2. Number and location of straps shall be as specified by manufacturer.
- 2.2.8.3. Each strap shall be capable of withstanding a maximum load of 25,000 lbs.

#### 2.2.9. Prefabricated Concrete Deadmen Anchors

- 2.2.9.1. Design Conditions – Deadmen shall meet the following design criteria:

- Deadman shall be designed to ACI 318
- Manufactured with 4,000 psig concrete
- Manufactured in various lengths
- Provide adjustable anchor points for hold down straps

#### 2.2.10. Liquid Sensor Drawstring

- 2.2.10.1. Galvanized steel drawstring shall be factory installed at the monitoring fitting to facilitate field insertion of sensor.

#### 2.2.11. Fittings Threaded NPT

- 2.2.11.1. All threaded fittings shall be located on a manway cover or within 12" of the tank top center line. Fittings to be supplied with temporary thread protectors or threaded plugs.
- 2.2.11.2. All standard fittings shall be 4" diameter NPT half couplings.
- 2.2.11.3. Internal piping shall be terminated at least 4" from the tank bottom (6" for 12' diameter tanks).

### 3. EXECUTION

#### 3.1. Installation and Testing

- 3.1.1. Fiberglass underground tanks must be tested and installed according to the current installation instructions provided with the tank (refer to Containment Solutions Pub. No. INST 6001). Tanks are installed with pea gravel or crushed stone as specified in current installation instructions. Containment Solutions' tanks are intended for storing products listed in the warranty; any other products not listed in the warranty must be approved in advance by Containment Solutions.

### 4. LIMITED WARRANTY

#### 4.1. Limited Warranty

- 4.1.1. Warranty shall be Containment Solutions limited warranty in effect at time of delivery.

MARK	QTY	SIZE	EQUIPMENT LISTING	MARK	QTY	SIZE	EQUIPMENT LISTING	MARK	QTY	SIZE	EQUIPMENT LISTING
A	1	8"	HYDROSTATIC DOUBLE WALL COMPARTMENT TANK	I	1*		INVENTORY & LEAK DETECTION PANEL	Q	2*		OVERFILL PREVENTION VALVE
B	2	48"	SINGLE WALL CONTAINMENT COLLAR	J	4*		CONTAINMENT COLLAR SENSOR	R	2*	4"	DROP TUBE
C	2	48"	SW PTS WATER TIGHT TURBINE SUMP	K	1*		FUEL DISPENSER w/UDC	S	4*	4"	BALL FLOAT ASSEMBLY
D	2	42"	SINGLE WALL CONTAINMENT COLLAR	L	2*		TANK INVENTORY GAUGE	T	2*	36"	WATERTIGHT MANHOLE
E	2	42"	SW PTS FILL/VAPOR SUMP	M	1*		HYDROSTATIC TANK RESERVOIR SENSOR	U	**		DOUBLE WALL FRP PIPE
F	6		HOLD DOWN SPLIT STRAP ASSEMBLY	N	2*	36"	MULTI-PORT SPILL CONTAINMENT MANHOLE	V	2*	4"	EXTRACTOR HOUSING w/CAP
G	4	12'	12" x 12" CONCRETE DEADMAN ANCHORS	O	2*	2"	PRIMARY TANK VENT	W	1*	18"	MANHOLE
H	2*		SUBMERSIBLE PUMP w/LEAK DETECTION	P	1*	2"	SUMP VENTS - (MANIFOLDED)	X	1*		PUMP CONTROL PANEL

NOTE: \* SUPPLIED BY OTHERS

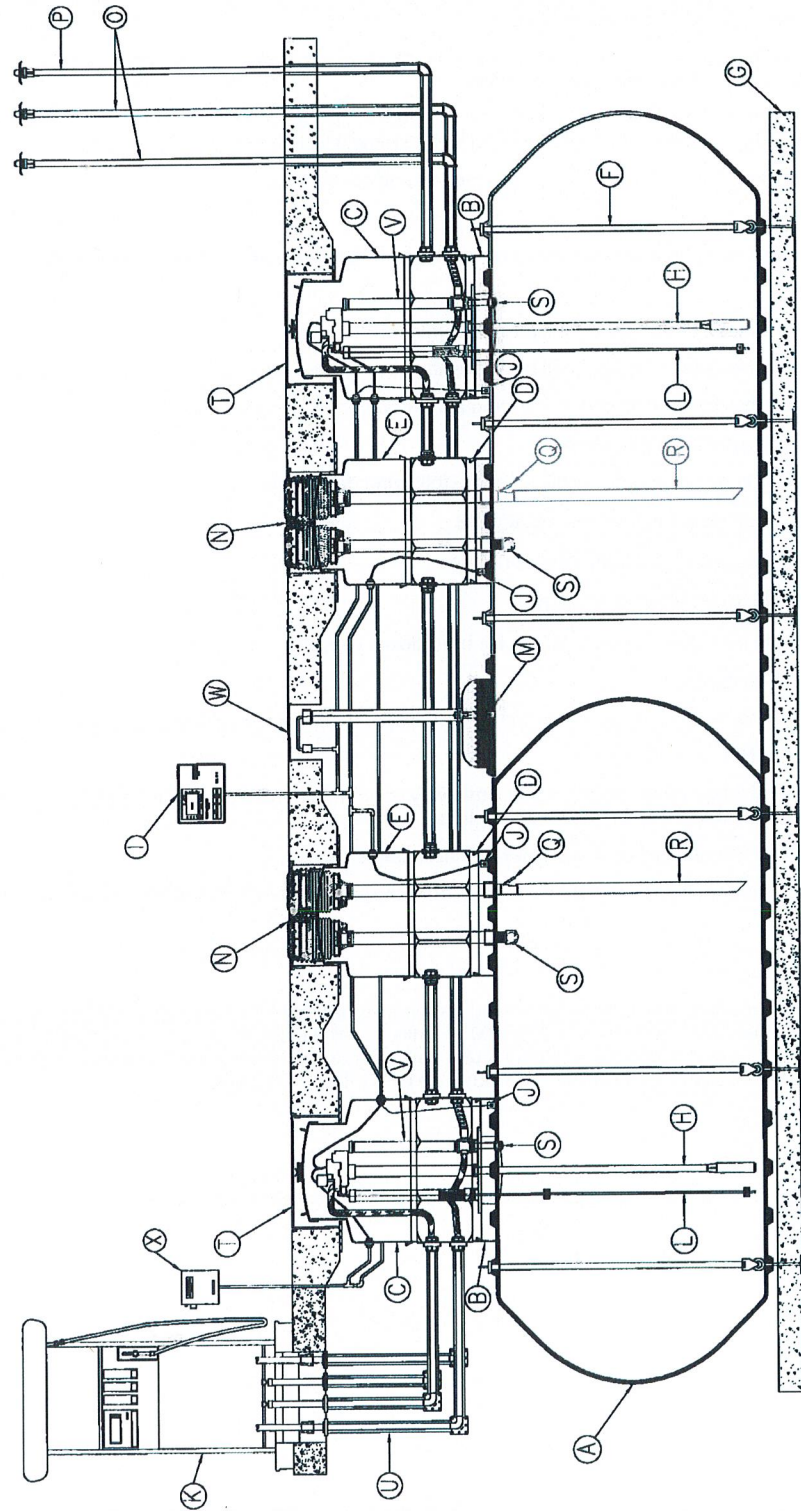

TYPICAL PETROLEUM ILLUSTRATION DRAWING  
 (8') 6,000 / 6,000 DOUBLE-WALL COMPARTMENT TANK  
 W / SINGLE-WALL TURBINE AND FILL / VAPOR SUMPS



**CONTAINMENT  
 SOLUTION S.**

Pub. No. TYP-666DB2-STD JANUARY 2014

THIS DIAGRAM IS THE PROPERTY OF CONTAINMENT SOLUTIONS, INC. AND IS FOR ILLUSTRATION PURPOSES ONLY. IT IS NOT TO BE RELIED UPON FOR ANY OTHER PURPOSE. NO WARRANTY OF MERCHANTABILITY OF FITNESS FOR A PARTICULAR PURPOSE OR OF ANY OTHER KIND, EXPRESSED OR IMPLIED IS HEREBY MADE. COPYRIGHT © 2009 CONTAINMENT SOLUTIONS, INC. ALL RIGHTS RESERVED.

**AFFIDAVIT OF POSTING(S) OF  
NOTICE OF PUBLIC HEARING  
AT THE PROPERTY**

STATE OF NEW YORK: COUNTY OF ORANGE:

I, Jarrod Bizz, being duly sworn, depose and say that I did on or before  
August 12, 2021, post and will thereafter maintain at  
5200 Route 9w 43-5-1 B Zone in the Town of Newburgh, New York, at or near the front  
property line(s) and within view of each fronting street a copy(ies) of the Notice of Public Hearing, which  
notice was in the form attached hereto.

The applicant shall maintain and update notice(s) (with amended information if there is any change to the information contained in the original Notice of Hearing) until after the Public Hearing is closed. The Notice must then be removed and property disposed of within ten (10) days of the close of the Public Hearing. Failure to follow the required procedure may result in the Public Hearing being held open for additional time.

Sworn to before me this 2

day of August, 2021.

Jarrod Bizz



LISA M. AYERS  
Notary Public, State of New York  
Registration No. 01AY6400708  
Qualified in Orange County  
My Commission Expires November 03, 2023

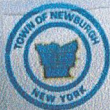

**TOWN OF NEWBURGH**

Committee of the Board  
ZONING BOARD OF APPEALS  
21 Hudson Valley Professional Plaza  
Newburgh, NY 12550

OFFICE OF ZONING BOARD  
TELEPHONE 845-564-9981  
FAX LINE 845-564-7982

**NOTICE OF HEARING**

NOTICE is hereby given that, pursuant to Section 267-a (1) of the Town Law, State of New York and Section 185-55A (1) of the Zoning Ordinances of the Town of Newburgh, a Public Hearing will be held by the Zoning Board of Appeals of the Town of Newburgh, New York on Thursday the 26th day of August, 2021 at 7:00 P.M. in the Town Hall, 14-16 Route 300, Town of Newburgh, New York, to act upon the following appeal:

APPLICATION of Gas Land Petroleum, Inc. (Planning Board re-referred) for a rehearing from the May 27, 2021 meeting for the variances of relief of the 3000 ft requirement to the nearest surface water feature and lot building lines with apartment requiring variances for front yard, side yard, height and maximum yard area.

PREMISES LOCATED AT 5200 Route 9W, 13 S.E. 1/4, 2nd in the Town of Newburgh, New York.

TAKE NOTICE that the applicant should appear at the hearing and all persons interested in any way may appear and be heard by the Board.

BY ORDER of the Zoning Board of Appeals dated the 23rd day of August, 2021.

2021

SUPERVISOR

\*Any members of the public that plan on attending the meeting are required to wear a mask.

Aug 2, 2021 2:07:35 PM  
5198 Route 9W  
Newburgh  
Orange County  
New York







**TOWN OF NEWBURGH**

*County of the North*  
ZONING BOARD OF APPEALS  
21 Hudson Valley Professional Plaza  
Newburgh, NY 12550

OFFICE OF ZONING BOARD  
TELEPHONE 845-566-4901  
FAX LINE 845-564-7802

**NOTICE OF HEARING**

NOTICE is hereby given that, pursuant to Section 267-a (1) of the Town Law, State of New York and Section 185-55A (1) of the Zoning Ordinances of the Town of Newburgh, a Public Hearing will be held by the Zoning Board of Appeals of the Town of Newburgh, New York on Thursday the 26th day of August, 2021 at 7:00 P.M., in the Town Hall, 1496 Route 300, Town of Newburgh, New York, to act upon the following appeal:

APPLICATION of Gas Land Petroleum, Inc. (Planning Board re-referral) for a rehearing from the May 27, 2021 meeting for area variances of relief of the 1000 ft requirement to the nearest motor vehicle station and an existing barn with apartment requiring variances for front yard, side yard, height and maximum yard area.

PREMISES LOCATED at 5200 Route 9w 43-5-1 B Zone in the Town of Newburgh, New York.

TAKE NOTICE that the applicant should appear at the hearing and all persons interested in any way may appear and be heard by the Board.

BY ORDER of the Zoning Board of Appeals dated the 12th day of August, 2021.

  
(APPLICANT)

\*Any members of the public that plan on attending the meeting are required to wear a mask.

Aug 4, 2021 1:17:09 PM  
38 Albany Post Road  
Newburgh  
Orange County  
New York

