

Robert Petrillo  
November 20, 2014

Page 2

The 1,876 SF residence has been vacant for a number of years, during which time it has been vandalized by the removal of all of the copper plumbing; the roof has leaked in the frame addition causing the carpeting to get wet and rot the basement beams so badly that the structure above it has become unsafe; and, a severe mold problem has developed. The stone section of the dwelling has only two rooms – a living room and above it a bedroom. While this building has also suffered from the cold and lack of ventilation, it is not as severe as the frame addition. However, without the frame addition, it lacks functionality. It is therefore my recommendation that the entire residence – stone and frame be razed; the cost of which must be deducted from the overall value of the land.

Using comparable sales in the Town of Newburgh, I was able to estimate that the value of the 1.6 acres of land – without any buildings on it, was \$64,500.

Demolition and removal costs were calculated by use of the Marshall and Swift Appraisal Manual (excluding the barn and outbuilding). The cost of demolition and removal were determined to be \$7,850 (\$4.18/SF). Dumping fees were estimated to cost \$5,000.

The total cost of demolition, removal and dumping fees is thus \$12,850.

The remaining value of the land equates to \$51,650.

As previously mentioned, my full appraisal report has been forwarded to you and this report contains all of the data that I have relied upon to formulate the value conclusions summarized above.

**TOWN OF NEWBURGH**

Recreation Department  
 311 Route 32  
 Newburgh, New York 12550  
 (845)564-7815

DEPARTMENT Recreation Department

CLAIMANT'S NAME ELDRED P. CARHART APPRAISER  
 AND ADDRESS 66 BALMVILLE RD  
 NEWBURGH N.Y 12550

TERMS \_\_\_\_\_

DO NOT WRITE IN THIS BOX

Date Voucher Received		VOUCHER NO.
FUND - APPROPRIATION	AMOUNT	
Total		
Abstract #		

Invoice # \_\_\_\_\_

Dates	Quantity	Description of Materials or Services	Unit Price	Amount
11/10/14		APPRAISAL REPORT FOR 617 RTE 32 (BAXTER Prop.) NEWBURGH N.Y 12550		400. <sup>00</sup> / <sub>100</sub>
TOTAL				400. <sup>00</sup> / <sub>100</sub>

Due

**CLAIMANT'S CERTIFICATION**

ELDRED P. CARHART certify that the above account in the amount of \$ 400.<sup>00</sup>/<sub>100</sub> is true and correct; that the items, services and disbursements charged were rendered to or for the municipality on the dates stated; that no part has been paid or "at billed"; that taxes, from which the municipality is exempt, are not included; and that the amount claimed is actually due.

12/1/14

DATE

Eldred P. Carhart

SIGNATURE

TITLE

(Space below for municipal use)

**DEPARTMENT APPROVAL**

The above services or materials were rendered or furnished to the municipality on the dates stated and the charges are correct.

Date

Authorized Official

**APPROVAL FOR PAYMENT**

This claim is approved and ordered for paid from the appropriations indicate above

Date

Auditing Board

\*\*\*\*\* INVOICE \*\*\*\*\*

File Number: 14028A2.EPC, 617 RT 32

Eldred P. Carhart, Appraiser  
Eldred P. Carhart, Appraisals  
66 Balmville Road  
Newburgh, NY 12550

Borrower : None

Invoice # :  
Order Date :  
Reference/Case # : TOWN OF NEWBURGH  
PO Number :

617 NY Route 32\*  
Town of Newburgh, New York, 12550

Appraisal Report	\$	400.00
	\$	
		-----
Invoice Total	\$	400.00
State Sales Tax @	\$	0.00
Deposit	(\$	)
Deposit	(\$	)
		-----
Amount Due	\$	400.00

Terms:

Please Make Check Payable To:

Eldred P. Carhart, Appraiser

Fed. I.D. #: 131302299

## PROPOSAL TO THE TOWN OF NEWBURGH

Dated: 11-12-14

Robert George and Elizabeth Ann Leonard (husband and wife) jointly offer to buy from the Town of Newburgh the "Baxter Property" located at 617 Route 32, Newburgh, NY. The 1.6 acre parcel includes a 100+ year old part stone and part wood structure consisting of three bedrooms and one bath, a workshop and a 3 seat outhouse.

This is a cash offer for \$40,000.00 (forty thousand and no/100 dollars).

Proposed "Scope of Work" to the property is as follows:

- 1) Demolish wood structure. Current wood structure is full of black mold/rot and has been vandalized making it unfeasible to restore.
- 2) Rebuild new wood portion (same 'footprint') to fit style of stone portion of house, repurposing any salvageable materials.
- 3) Save and restore stone section of house (new roof, floor joist, concrete slab in basement, electrical, plumbing, strip lead paint from all doors and trim inside and out and refinish).
- 4) Remove four large trees (locust & pine) endangering the structure.
- 5) Restore workshop.
- 6) The additional original "Baxter Property" owned by the Town of Newburgh has two large barns located on them. One is in good condition and the other poor. We offer to the town of Newburgh to remove the barn in poor condition, free of cost, leaving only its foundation and pad. We will take any salvageable materials for ourselves and dispose of the rest.



475 McKinstry Road  
Gardiner, NY 12525

(845) 255-4258  
(845) 943-1197  
Recleo@juno.com

## Robert G. & Elizabeth A. Leonard

### Objective

Acquaint the Town of Newburgh with the Leonard's.

Who we are: Robert and Elizabeth Leonard (husband & wife for 38 years).  
Raised one son (28 years old).

New York residence for 16+ years and currently residing at above address.

### Experience

1989 - 2014 Leonard's Construction

#### Licensed General Contractor

- 5 Years –(prior to 1989) Carpentry Apprentice in Santa Barbara/Big Bear Lake, California
- Licensed General Contractor for 25 years ( family business )
- Constructed 12 homes (1,400 – 4,000 sq ft) from raw land to “turn key” (all phases of construction: design, land preparation [utility infrastructure, tree removal and site works], concrete foundation , framing, siding, electrical, plumbing, drywall, painting, roofing, finish carpentry,cabinet millwork and concrete flatwork).
- Purchased several additional homes that were in need of major repair and refurbished them.
- As opportunity presents itself we enjoy volunteering our construction skills in community projects, disaster relief work and helping friends and neighbors in need both in the States and abroad.

### Education

1962 – 1975 K- High School Big Bear Lake, CA

- General Contractor License since 1989.
- Numerous trade seminars/ classes/ certifications including certification in Brooklyn, NY for mold remediation and certification in Kingston, NY for safe lead removal.

### Interests

Community support projects, volunteer disaster relief efforts, outdoor activity (hiking, biking, canoeing skiing, camping and the like).











# KALA

Karen Arent Landscape Architect

14B

---

## Memorandum

**To:** Supervisor Gil Piaquadio and the Town of Newburgh Board

**From:** Karen Arent, Landscape Architect

**Date:** December 8, 2014

**Subject:** Golden Vista Landscape Improvement Bond Estimate

**Town Project Number:** 1999-33

**Cc:** Chairman John Ewasutyn and the Town of Newburgh Planning Board,  
Ms. Cindy Martinez, Mark Taylor, Esq., Mr. Gerald Canfield

### COMMENTS:

---

Attached for the Town Board's review is a landscape cost estimate for the above referenced project. The cost estimate, for the amount of \$109,359, is reasonable.

The project may require a landscape inspection fee. The landscape inspection fee for this project, if applicable, is \$4,000.

The above requires Town Board action and should be placed on your next available agenda.

# KALA

Karen Arent Landscape Architect

---

## Memorandum

**To:** Supervisor Gil Piaquadio and the Town of Newburgh Board

**From:** Karen Arent, Landscape Architect

**Date:** December 8, 2014

**Subject:** Golden Vista Landscape Improvement Bond Estimate

**Town Project Number:** 1999-33

**Cc:** Chairman John Ewasutyn and the Town of Newburgh Planning Board,  
Ms. Cindy Martinez, Mark Taylor, Esq., Mr. Gerald Canfield

## COMMENTS:

---

Attached for the Town Board's review is a landscape cost estimate for the above referenced project. The cost estimate, for the amount of \$109,359, is reasonable.

The project may require a landscape inspection fee. The landscape inspection fee for this project, if applicable, is \$4,000.

The above requires Town Board action and should be placed on your next available agenda.

**KIRK ROTHER, PE, PLLC**  
CONSULTING ENGINEER, PLLC

5 Saint Stephens Lane  
Phone (845) 988-0620  
Fax (845) 988-1628

Warwick, NY 10990  
Email krother@kirkrother.com

**Golden Vista Multifamily Residential Plan**  
Town of Newburgh, Orange County, New York  
Landscaping Cost Estimate  
Prepared 03-12-12

Item Description	Quantity	Unit	Unit Cost	Total
<b>Stormwater Management Area Plants</b>				
Sycamore - <i>Plantanus occidentalis</i>	2	B & B	\$200.00	\$400.00
Silky Dogwood - <i>Cornus amomium</i>	122	B & B	\$30.00	\$3,660.00
Sedges - <i>Carex spp</i>	175	B & B	\$15.00	\$2,625.00
Cattail - <i>Typha sp</i>	125	B & B	\$3.00	\$375.00
Hardstem Bulrush - <i>Scirpus acutus</i>	75	B & B	\$3.00	\$225.00
Softstem Bulrush - <i>Scirpus validus</i>	100	B & B	\$3.00	\$300.00
Smartweed - <i>Polygonum spp</i>	455	B & B	\$3.00	\$1,365.00
<b>Sub Total</b>				<b>\$8,950.00</b>
<b>Common Areas</b>				
Sugar Maple - <i>Acer saccharum</i>	4	B & B	\$350.00	\$1,400.00
White Oak - <i>Quercus alba</i>	1	B & B	\$450.00	\$450.00
Pin Oak - <i>Quercus palustris</i>	8	B & B	\$320.00	\$2,560.00
Black Tupelo - <i>Nyssa sylvatica</i>	7	B & B	\$280.00	\$1,960.00
Red Bud - <i>Cercis canadensis</i>	6	B & B	\$325.00	\$1,950.00
Heritage River Birch - <i>Betula nigra 'Heritage'</i>	2	B & B	\$320.00	\$640.00
White Dogwood - <i>Cornus florida</i>	7	B & B	\$300.00	\$2,100.00
Red Maple - <i>Acer rubrum</i>	10	B & B	\$340.00	\$3,400.00
Shagbark Hickory - <i>Carya ovata</i>	4	B & B	\$275.00	\$1,100.00
Norway Spruce - <i>Picea abies</i>	19	B & B	\$150.00	\$2,850.00
White pine - <i>Pinus strobus</i>	13	B & B	\$300.00	\$3,900.00
American Beech - <i>Fagus grandifolia</i>	1	B & B	\$350.00	\$350.00
Hyperion Daylily - <i>hemerocallis 'Hyperion'</i>	28	12" - 24"	\$8.00	\$224.00
Mount Hood Daffodil - <i>narcissus 'Mount Hood'</i>	100	12" - 24"	\$3.00	\$300.00
<b>Sub Total</b>				<b>\$23,184.00</b>
<b>Perimeter Screening Plants</b>				
Norway Spruce - <i>Picea abies</i>	38	B & B	\$150.00	\$5,700.00
Shagbark Hickory - <i>Carya ovata</i>	4	B & B	\$275.00	\$1,100.00
Heritage River Birch - <i>Betula nigra 'Heritage'</i>	1	B & B	\$320.00	\$320.00
White Dogwood - <i>Cornus florida</i>	3	B & B	\$300.00	\$900.00
Red Maple - <i>Acer rubrum</i>	2	B & B	\$340.00	\$680.00
White pine - <i>Pinus strobus</i>	70	B & B	\$200.00	\$14,000.00
<b>Sub Total</b>				<b>\$22,700.00</b>

<b>Building 1 Plants</b>				
Norway Spruce - Picea abies	1	B & B	\$150.00	\$150.00
American Holly - Ilex opaca	4	B & B	\$300.00	\$1,200.00
Holly - Ilex glabra "compacta"	24	5 Gal.	\$45.00	\$1,080.00
Hydrangea - Hydrangea arborescens "annabelle"	4	5 Gal.	\$40.00	\$160.00
Stella D'oro Daylily - Hemerocallis Stella d'Oro	36	2 Gal.	\$25.00	\$900.00
Finished Lawn Areas	1	30 lbs	\$150.00	\$150.00
<b>Sub Total</b>				<b>\$3,640.00</b>

<b>Building 2 Plants</b>				
Norway Spruce - Picea abies	2	B & B	\$150.00	\$300.00
American Holly - Ilex opaca	2	B & B	\$300.00	\$600.00
Holly - Ilex glabra "compacta"	24	5 Gal.	\$45.00	\$1,080.00
Hydrangea - Hydrangea arborescens "annabelle"	4	5 Gal.	\$40.00	\$160.00
Hayscented Fern - Dennstaedtia punctilobula	36	1 Gal.	\$25.00	\$900.00
Finished Lawn Areas	1	30 lbs	\$150.00	\$150.00
<b>Sub Total</b>				<b>\$3,190.00</b>

<b>Building 3 Plants</b>				
Norway Spruce - Picea abies	3	B & B	\$150.00	\$450.00
American Holly - Ilex opaca	1	B & B	\$300.00	\$300.00
Holly - Ilex glabra "compacta"	24	5 Gal.	\$45.00	\$1,080.00
Hydrangea - Hydrangea arborescens "annabelle"	4	5 Gal.	\$40.00	\$160.00
Stella D'oro Daylily - Hemerocallis Stella d'Oro	36	2 Gal.	\$25.00	\$900.00
Finished Lawn Areas	1	30 lbs	\$150.00	\$150.00
<b>Sub Total</b>				<b>\$3,040.00</b>

<b>Building 4 Plants</b>				
Norway Spruce - Picea abies	2	B & B	\$150.00	\$300.00
American Holly - Ilex opaca	2	B & B	\$300.00	\$600.00
Holly - Ilex glabra "compacta"	24	5 Gal.	\$45.00	\$1,080.00
Hydrangea - Hydrangea arborescens "annabelle"	4	5 Gal.	\$40.00	\$160.00
Stella D'oro Daylily - Hemerocallis Stella d'Oro	36	2 Gal.	\$25.00	\$900.00
Finished Lawn Areas	1	30 lbs	\$150.00	\$150.00
<b>Sub Total</b>				<b>\$3,190.00</b>

<b>Building 5 Plants</b>				
Norway Spruce - Picea abies	2	B & B	\$150.00	\$300.00
American Holly - Ilex opaca	2	B & B	\$300.00	\$600.00
Holly - Ilex glabra "compacta"	24	5 Gal.	\$45.00	\$1,080.00
Hydrangea - Hydrangea arborescens "annabelle"	4	5 Gal.	\$40.00	\$160.00
Hayscented Fern - Dennstaedtia punctilobula	36	1 Gal.	\$25.00	\$900.00
Finished Lawn Areas	1	30 lbs	\$150.00	\$150.00
<b>Sub Total</b>				<b>\$3,190.00</b>

<b>Building 6 Plants</b>				
Norway Spruce - Picea abies	1	B & B	\$150.00	\$150.00
American Holly - Ilex opaca	2	B & B	\$300.00	\$600.00
Holly - Ilex glabra "compacta"	24	5 Gal.	\$45.00	\$1,080.00
Hydrangea - Hydrangea arborescens "annabelle"	4	5 Gal.	\$40.00	\$160.00
Stella D'oro Daylily - Hemerocallis Stella d'Oro	56	2 Gal.	\$25.00	\$1,400.00
Mulch	3	yard	\$50.00	\$150.00
Finished Lawn Areas	1	30 lbs	\$150.00	\$150.00
<b>Sub Total</b>				<b>\$3,690.00</b>



<u>Building 7 Plants</u>				
Norway Spruce - Picea abies	2	B & B	\$150.00	\$300.00
American Holly - Ilex opaca	2	B & B	\$300.00	\$600.00
Holly - Ilex glabra "compacta"	24	5 Gal.	\$45.00	\$1,080.00
Hydrangea - Hydrangea arborescens "annabelle"	4	5 Gal.	\$40.00	\$160.00
Hayscented Fern - Dennstaedtia punctilobula	36	1 Gal.	\$25.00	\$900.00
Finished Lawn Areas	1	30 lbs	\$150.00	\$150.00
<b>Sub Total</b>				<b>\$3,190.00</b>

<u>Building 8 Plants</u>				
Norway Spruce - Picea abies	3	B & B	\$150.00	\$450.00
American Holly - Ilex opaca	2	B & B	\$300.00	\$600.00
Holly - Ilex glabra "compacta"	24	5 Gal.	\$45.00	\$1,080.00
Hydrangea - Hydrangea arborescens "annabelle"	4	5 Gal.	\$40.00	\$160.00
Hayscented Fern - Dennstaedtia punctilobula	36	1 Gal.	\$25.00	\$900.00
Finished Lawn Areas	1	30 lbs	\$150.00	\$150.00
<b>Sub Total</b>				<b>\$3,340.00</b>

<u>Building 9 Plants</u>				
Norway Spruce - Picea abies	1	B & B	\$150.00	\$150.00
American Holly - Ilex opaca	2	B & B	\$300.00	\$600.00
Holly - Ilex glabra "compacta"	24	5 Gal.	\$45.00	\$1,080.00
Hydrangea - Hydrangea arborescens "annabelle"	4	5 Gal.	\$40.00	\$160.00
Hayscented Fern - Dennstaedtia punctilobula	36	1 Gal.	\$25.00	\$900.00
Finished Lawn Areas	1	30 lbs	\$150.00	\$150.00
<b>Sub Total</b>				<b>\$3,040.00</b>

<u>Building 10 Plants</u>				
Norway Spruce - Picea abies	2	B & B	\$150.00	\$300.00
American Holly - Ilex opaca	2	B & B	\$300.00	\$600.00
Holly - Ilex glabra "compacta"	24	5 Gal.	\$45.00	\$1,080.00
Hydrangea - Hydrangea arborescens "annabelle"	4	5 Gal.	\$40.00	\$160.00
Stella D'oro Daylily - Hemerocallis Stella d'Oro	36	2 Gal.	\$25.00	\$900.00
Finished Lawn Areas	1	30 lbs	\$150.00	\$150.00
<b>Sub Total</b>				<b>\$3,190.00</b>

<u>Building 11 Plants</u>				
Norway Spruce - Picea abies	2	B & B	\$150.00	\$300.00
American Holly - Ilex opaca	2	B & B	\$300.00	\$600.00
Holly - Ilex glabra "compacta"	24	5 Gal.	\$45.00	\$1,080.00
Hydrangea - Hydrangea arborescens "annabelle"	4	5 Gal.	\$40.00	\$160.00
Stella D'oro Daylily - Hemerocallis Stella d'Oro	36	2 Gal.	\$25.00	\$900.00
Finished Lawn Areas	1	30 lbs	\$150.00	\$150.00
<b>Sub Total</b>				<b>\$3,190.00</b>

<u>Street Trees (including island)</u>				
Sugar Maple - Acer saccharum	13	B & B	\$350.00	\$4,550.00
White Oak - Quercus alba	1	B & B	\$450.00	\$450.00
Pin Oak - Quercus palustris	11	B & B	\$320.00	\$3,520.00
Black Tupelo - Nyssa sylvatica	26	B & B	\$280.00	\$7,280.00
Red Bud - Cercis canadensis	3	B & B	\$325.00	\$975.00
Heritage River Birch - Betula nigra 'Heritage'	1	B & B	\$320.00	\$320.00
White Dogwood - Cornus florida	3	B & B	\$300.00	\$900.00
Blue Rug Juniper - Juniperus horizontalis 'Wiltonii'	80	2 Gal.	\$8.00	\$640.00
<b>Sub Total</b>				<b>\$18,635.00</b>

**Total** **\$109,359.00**

# KALA

Karen Arent Landscape Architect

## Memorandum

**To:** Supervisor Gil Piaquadio and the Town of Newburgh Board

**From:** Karen Arent, Landscape Architect

**Date:** December 23, 2014

**Subject:** Mountain Lakes Subdivision, off Rock Cut Road

**Town Project Number:** 2004-61

**Cc:** Chairman John Ewasutyn and the Town of Newburgh Planning Board, Ms. Cindy Martinez, Mark Taylor, Esq., Attorney for the Town of Newburgh Board, Mr. Gerald Canfield, Code Enforcement for the Town of Newburgh, Mr. James Osborne

## COMMENTS:

The site was inspected on Tuesday December 16. Work listed on the inspection memorandum dated November 15, 2013 was completed. Most trees appear to be alive and well although it is difficult to accurately assess trees this time of year. A couple of street trees near the entrance to the site appear to be mostly dead. The applicant has had trees replaced several times. It is my recommendation to release the rest of the bond at this time, although the board may want to wait until trees leaf out in the spring for a more accurate assessment.

According to my records, the remaining bond held for this project is \$49,410. The bond was incrementally released previously.

TOWN OF NEWBURGH  
TOWN ENGINEER  
1496 Rte. 300  
Newburgh, NY 12550  
(845) 564-7814

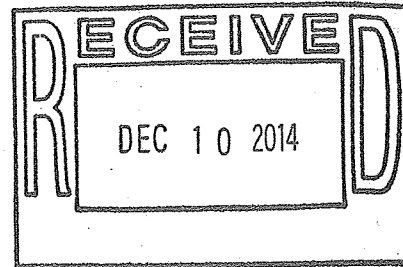

**MEMORANDUM**

**TO:** Gil Piaquadio, Deputy Supervisor & Town Board  
**FROM:** James W. Osborne, Town Engineer *JWO*  
**DATE:** December 9, 2014  
**RE:** W\ 2014 WATER SYSTEM CAPITAL IMPROVEMENTS

---

I am requesting Town Board approval of an interfund transfer from the Water Fund to the Water System Capital Improvements Project as delineated below:

From: Transfers (#9902-0900)  
To: Capital Project No. 6003.0200  
Amount: \$400,000

As the above requires Town Board action, I am requesting that this item be placed on the next available agenda for approval. If you have any questions or comments, I am available to discuss them with you.

JWO/id

cc: J. Platt, DPW Comm.  
R. Clum, Accountant

At a regular meeting of the Town Board of the Town of Newburgh, Orange County, New York, held at the Town Hall, in Newburgh, New York on December 10, 2014, at 7:00 o'clock P.M., Prevailing Time.

PRESENT:

Gilbert J. Piaquadio  
Deputy Supervisor and Councilman

George Woolsey  
Councilman

Elizabeth J. Greene  
Councilwoman

Paul I. Ruggiero  
Councilman

In the Matter of The Increase and Improvement of the Facilities of Consolidated Water District, in the Town of Newburgh, Orange County, New York	PUBLIC INTEREST ORDER
--	-----------------------------

WHEREAS, the Town Board of the Town of Newburgh, Orange County, New York, has caused to be prepared a map, plan and report, including an estimate of cost, pursuant to Section 202-b of the Town Law, relating to the increase and improvement of the facilities of the Consolidated Water District, in the Town of Newburgh, Orange County, New York (the "Water District"), being the improvements to the water storage, distribution and filtration system, including original furnishings, equipment, machinery, apparatus, appurtenances, and incidental improvements and expenses in connection therewith, at a maximum estimated cost of \$4,230,300; and

WHEREAS, at a meeting of said Town Board duly called and held on September 15, 2014, an Order was adopted by it and entered in the minutes specifying the said Town Board would meet to consider said increase and improvement of the Water District, and to hear all persons interested in the subject thereof concerning the same at the Town Hall, in Newburgh, New York, in said Town, on October 20, 2014 at 7:00 o'clock P.M., Prevailing Time; and

WHEREAS, said Order duly certified by the Town Clerk was duly published and posted as required by law; and

WHEREAS, a public hearing was duly held at the time and place set forth in said notice, at which all persons desiring to be heard were duly heard; NOW, THEREFORE, BE IT

ORDERED, by the Town Board of the Town of Newburgh, Orange County, New York, as follows:

Section 1. Upon the evidence given at the aforesaid public hearing, it is hereby found and determined that it is in the public interest to make improvements to the Consolidated Water District in the Town of Newburgh, Orange County, New York, consisting of the improvements to the water storage, distribution and filtration system, including original furnishings, equipment, machinery, apparatus, appurtenances, and incidental improvements and expenses in connection therewith, at a maximum estimated cost of \$4,230,300.

Section 2. This Order shall take effect immediately.

The question of the adoption of the foregoing order was duly put to a vote on roll, which resulted as follows:

George Woolsey, Councilman VOTING \_\_\_\_\_

Elizabeth J. Greene, Councilwoman VOTING \_\_\_\_\_

Paul I. Ruggiero, Councilman VOTING \_\_\_\_\_

Gilbert J. Piaquadio, Deputy Supervisor and Councilman VOTING \_\_\_\_\_

The order was thereupon declared duly adopted.

\* \* \* \* \*



Rider Weiner & Frankel P.C.  
ATTORNEYS & COUNSELORS AT LAW

P: 845.562.9100

F: 845.562.9126

655 Little Britain Road  
New Windsor, NY 12553

P.O. Box 2280  
Newburgh, NY 12550

**ATTORNEYS**

David L. Rider  
Charles E. Frankel  
Michael J. Matsler  
Mark C. Taylor  
Deborah Weisman-Estis  
M. Justin Rider  
Jeffrey S. Sculley  
Donna M. Badura  
Alyson Pomerantz

*M. J. Rider*  
(1906-1968)  
*Elliott M. Weiner*  
(1915-1990)

**COUNSEL**

Stephen P. Duggan, III  
John K. McGuirk

**OF COUNSEL**

Craig F. Simon

**MEMORANDUM**

TO: HON. GILBERT J. PIAQUADIO, DEPUTY AND ACTING  
SUPERVISOR  
TOWN BOARD MEMBERS

FROM: MARK C. TAYLOR, ATTORNEY FOR THE TOWN

RE: 2014 WATER SYSTEM CAPITAL IMPROVEMENTS PROJECT  
(F/K/A STEWART WATER TANK PROJECT)  
OUR FILE NO. 801. \_\_\_\_\_

DATE: DECEMBER 9, 2014

Enclosed please find a Bond Resolution for the above project for the Town Board's consideration. As you know, the Board has previously conducted a public hearing and adopted a Public Interest Order following the close of the public hearing held on October 20, 2014.

Please note that the Bond Resolution provides for an authorization for the issuance of bonds in a lesser amount than the total project costs based upon the Town's estimation of available funds for the project already in hand.

Should you have any questions in this regard, please feel free to contact me.

cc: Andrew J. Zarutskie, Town Clerk  
James Osborne, Town Engineer (via e-mail)  
John Platt, Commissioner of Public Works (via e-mail)  
Ronald Clum, Town Accountant (via e-mail)

**BOND RESOLUTION**

At a regular meeting of the Town Board of the Town of Newburgh, Orange County, New York, held at the Town Hall, in Newburgh, New York, in said Town, on the 10<sup>th</sup> day of December, 2014, at 7:00 o'clock P.M., Prevailing Time. The meeting was called to order by Deputy Supervisor and Councilman Piaquadio, and upon roll being called, the following were

PRESENT:

Gilbert J. Piaquadio, Deputy Supervisor and Councilman  
George Woolsey, Councilman  
Elizabeth J. Greene, Councilwoman  
Paul I. Ruggiero, Councilman

ABSENT:

The following resolution was offered by Councilman/woman \_\_\_\_\_ who moved its adoption, seconded by Councilman/woman \_\_\_\_\_ to-wit:



BOND RESOLUTION DATED DECEMBER 10, 2014.

A RESOLUTION AUTHORIZING THE ISSUANCE OF \$2,980,300 BONDS AND THE EXPENDITURE OF \$1,250,000 AVAILABLE FUND MONIES OF THE TOWN OF NEWBURGH, ORANGE COUNTY, NEW YORK, TO PAY THE COST OF THE INCREASE AND IMPROVEMENT OF THE CONSOLIDATED WATER DISTRICT IN THE TOWN OF NEWBURGH, ORANGE COUNTY, NEW YORK.

WHEREAS, the capital project hereinafter described has been determined to be an Type I Action pursuant to the regulations of the New York State Department of Environmental Conservation promulgated pursuant to the State Environmental Quality Review Act, the implementation of which as proposed, it has been determined will not result in a significant environmental effect; and

WHEREAS, pursuant to the provisions heretofore duly had and taken in accordance with the provisions of Section 202-b of the Town Law, and more particularly an Order dated October 20, 2014, said Town Board has determined it to be in the public interest to increase and improve the facilities of the Consolidated Water District in the Town of Newburgh, Orange County, New York (the "Water District"), being the improvements to the water storage, distribution and filtration system, including original furnishings, equipment, machinery, apparatus, appurtenances, and incidental improvements and expenses in connection therewith, at a maximum estimated cost of \$4,230,300; NOW, THEREFORE, BE IT

RESOLVED, by the Town Board of the Town of Newburgh, Orange County, New York, as follows:

Section 1. The increase and improvement of the facilities of the Consolidated Water District in the Town of Newburgh, Orange County, New York, being the improvements to the water storage, distribution and filtration system, including original furnishings, equipment,

machinery, apparatus, appurtenances, and incidental improvements and expenses in connection therewith, at a maximum estimated cost of \$4,230,300 is hereby authorized.

Section 2. The plan for the financing of the aforesaid maximum estimated cost shall consist of:

- a) the issuance of \$2,980,300 bonds of said Town hereby authorized to be issued therefor, pursuant to the provisions of the Local Finance Law; and
- b) the expenditure of \$1,250,000 available fund monies, hereby authorized to be expended therefor.

Section 3. It is hereby determined that the period of probable usefulness of the aforesaid specific object or purpose is forty years pursuant to subdivision 1 of paragraph a of Section 11.00 of the Local Finance Law. It is hereby further determined that the maximum maturity of the serial bonds herein authorized will exceed five years.

Section 4. The faith and credit of said Town of Newburgh, Orange County, New York, are hereby irrevocably pledged for the payment of the principal of and interest on such bonds as the same respectively become due and payable. An annual appropriation shall be made in each year sufficient to pay the principal of and interest on such bonds becoming due and payable in such year. To the extent not paid from monies raised from said Water District No. 1 as applicable in the manner provided by law, there shall annually be levied on all the taxable real property of said Town, a tax sufficient to pay the principal of and interest on such bonds as the same become due and payable.

Section 5. Subject to the provisions of the Local Finance Law, the power to authorize the issuance of and to sell bond anticipation notes in anticipation of the issuance and sale of the serial bonds herein authorized, including renewals of such notes, is hereby delegated to the

Supervisor, the chief fiscal officer. Such notes shall be of such terms, form and contents, and shall be sold in such manner, as may be prescribed by said Supervisor, consistent with the provisions of the Local Finance Law.

Section 6. The powers and duties of advertising such bonds for sale, conducting the sale and awarding the bonds, are hereby delegated to the Supervisor, who shall advertise such bonds for sale, conduct the sale, and award the bonds in such manner as she shall deem best for the interests of said Town, including, but not limited to, the power to sell said bonds to the New York State Environmental Facilities Corporation; provided, however, that in the exercise of these delegated powers, the Supervisor shall comply fully with the provisions of the Local Finance Law and any order or rule of the State Comptroller applicable to the sale of municipal bonds. The receipt of the Supervisor shall be a full acquittance to the purchaser of such bonds, who shall not be obliged to see to the application of the purchase money.

Section 7. All other matters except as provided herein relating to the serial bonds herein authorized including the date, denominations, maturities and interest payment dates, within the limitations prescribed herein and the manner of execution of the same, including the consolidation with other issues, and also the ability to issue serial bonds with substantially level or declining annual debt service, shall be determined by the Supervisor, the chief fiscal officer of such Town. Such bonds shall contain substantially the recital of validity clause provided for in Section 52.00 of the Local Finance Law, and shall otherwise be in such form and contain such recitals, in addition to those required by Section 51.00 of the Local Finance Law, as the Supervisor shall determine consistent with the provisions of the Local Finance Law.

Section 8. The Supervisor is hereby further authorized, at the Supervisor's sole discretion, to execute a project finance and/or loan agreement, and any other agreements with the

New York State Department of Health and/or the New York State Environmental Facilities Corporation, including amendments thereto, and including any instruments (or amendments thereto) in the effectuation thereof, in order to effect the financing or refinancing of the specific object or purpose described in Section 1 hereof, or a portion thereof, by a bond, and/or note issue of said Town in the event of the sale of same to the New York State Environmental Facilities Corporation.

Section 9. The power to issue and sell notes to the New York State Environmental Facilities corporation pursuant to Section 169.00 of the Local Finance Law is hereby delegated to the Supervisor. Such notes shall be of such terms, form and contents as may be prescribed by said Supervisor consistent with the provisions of the Local Finance Law.

Section 10. The validity of such bonds and bond anticipation notes may be contested only if:

- 1) Such obligations are authorized for an object or purpose for which said Town is not authorized to expend money, or
- 2) The provisions of law which should be complied with at the date of publication of this resolution are not substantially complied with,

and an action, suit or proceeding contesting such validity is commenced within twenty days after the date of such publication, or

- 3) Such obligations are authorized in violation of the provisions of the Constitution.

Section 11. This resolution shall constitute a statement of official intent for purposes of Treasury Regulations Section 1.150-2. Other than as specified in this resolution, no monies are, or are reasonably expected to be, reserved, allocated on a long-term basis, or otherwise set aside with respect to the permanent funding of the object or purpose described herein.

Section 12. This resolution, which takes effect immediately, shall be published in summary form in the official newspaper, together with a notice of the Town Clerk in substantially the form provided in Section 81.00 of the Local Finance Law.

The question of the adoption of the foregoing resolution was duly put to a vote on roll call, which resulted as follows:

George Woolsey, Councilman voting \_\_\_\_\_

Elizabeth J. Greene, Councilwoman voting \_\_\_\_\_

Paul I. Ruggiero, Councilman voting \_\_\_\_\_

Gilbert J. Piaquadio, Deputy Supervisor and Councilman voting \_\_\_\_\_

The resolution was thereupon declared duly adopted.

\* \* \* \* \*

**BOND RESOLUTION**

At a regular meeting of the Town Board of the Town of Newburgh, Orange County, New York, held at the Town Hall, in Newburgh, New York, in said Town, on the 10<sup>th</sup> day of December, 2014, at 7:00 o'clock P.M., Prevailing Time. The meeting was called to order by Deputy Supervisor and Councilman Piaquadio, and upon roll being called, the following were

**PRESENT:**

Gilbert J. Piaquadio, Deputy Supervisor and Councilman  
George Woolsey, Councilman  
Elizabeth J. Greene, Councilwoman  
Paul I. Ruggiero, Councilman

**ABSENT:**

The following resolution was offered by Councilman/woman \_\_\_\_\_ who moved its adoption, seconded by Councilman/woman \_\_\_\_\_ to-wit:

BOND RESOLUTION DATED DECEMBER 10, 2014.

A RESOLUTION AUTHORIZING THE ISSUANCE OF \$2,980,300 BONDS AND THE EXPENDITURE OF \$1,250,000 AVAILABLE FUND MONIES OF THE TOWN OF NEWBURGH, ORANGE COUNTY, NEW YORK, TO PAY THE COST OF THE INCREASE AND IMPROVEMENT OF THE CONSOLIDATED WATER DISTRICT IN THE TOWN OF NEWBURGH, ORANGE COUNTY, NEW YORK.

WHEREAS, the capital project hereinafter described has been determined to be an Type I Action pursuant to the regulations of the New York State Department of Environmental Conservation promulgated pursuant to the State Environmental Quality Review Act, the implementation of which as proposed, it has been determined will not result in a significant environmental effect; and

WHEREAS, pursuant to the provisions heretofore duly had and taken in accordance with the provisions of Section 202-b of the Town Law, and more particularly an Order dated December 10, 2014, said Town Board has determined it to be in the public interest to increase and improve the facilities of the Consolidated Water District in the Town of Newburgh, Orange County, New York (the "Water District"), being the improvements to the water storage, distribution and filtration system, including original furnishings, equipment, machinery, apparatus, appurtenances, and incidental improvements and expenses in connection therewith, at a maximum estimated cost of \$4,230,300; NOW, THEREFORE, BE IT

RESOLVED, by the Town Board of the Town of Newburgh, Orange County, New York, as follows:

Section 1. The increase and improvement of the facilities of the Consolidated Water District in the Town of Newburgh, Orange County, New York, being the improvements to the water storage, distribution and filtration system, including original furnishings, equipment,

machinery, apparatus, appurtenances, and incidental improvements and expenses in connection therewith, at a maximum estimated cost of \$4,230,300 is hereby authorized.

Section 2. The plan for the financing of the aforesaid maximum estimated cost shall consist of:

- a) the issuance of \$2,980,300 bonds of said Town hereby authorized to be issued therefor, pursuant to the provisions of the Local Finance Law; and
- b) the expenditure of \$1,250,000 available fund monies, hereby authorized to be expended therefor.

Section 3. It is hereby determined that the period of probable usefulness of the aforesaid specific object or purpose is forty years pursuant to subdivision 1 of paragraph a of Section 11.00 of the Local Finance Law. It is hereby further determined that the maximum maturity of the serial bonds herein authorized will exceed five years.

Section 4. The faith and credit of said Town of Newburgh, Orange County, New York, are hereby irrevocably pledged for the payment of the principal of and interest on such bonds as the same respectively become due and payable. An annual appropriation shall be made in each year sufficient to pay the principal of and interest on such bonds becoming due and payable in such year. To the extent not paid from monies raised from said Water District No. 1 as applicable in the manner provided by law, there shall annually be levied on all the taxable real property of said Town, a tax sufficient to pay the principal of and interest on such bonds as the same become due and payable.

Section 5. Subject to the provisions of the Local Finance Law, the power to authorize the issuance of and to sell bond anticipation notes in anticipation of the issuance and sale of the serial bonds herein authorized, including renewals of such notes, is hereby delegated to the



New York State Department of Health and/or the New York State Environmental Facilities Corporation, including amendments thereto, and including any instruments (or amendments thereto) in the effectuation thereof, in order to effect the financing or refinancing of the specific object or purpose described in Section 1 hereof, or a portion thereof, by a bond, and/or note issue of said Town in the event of the sale of same to the New York State Environmental Facilities Corporation.

Section 9. The power to issue and sell notes to the New York State Environmental Facilities corporation pursuant to Section 169.00 of the Local Finance Law is hereby delegated to the Supervisor. Such notes shall be of such terms, form and contents as may be prescribed by said Supervisor consistent with the provisions of the Local Finance Law.

Section 10. The validity of such bonds and bond anticipation notes may be contested only if:

- 1) Such obligations are authorized for an object or purpose for which said Town is not authorized to expend money, or
- 2) The provisions of law which should be complied with at the date of publication of this resolution are not substantially complied with,

and an action, suit or proceeding contesting such validity is commenced within twenty days after the date of such publication, or

- 3) Such obligations are authorized in violation of the provisions of the Constitution.

Section 11. This resolution shall constitute a statement of official intent for purposes of Treasury Regulations Section 1.150-2. Other than as specified in this resolution, no monies are, or are reasonably expected to be, reserved, allocated on a long-term basis, or otherwise set aside with respect to the permanent funding of the object or purpose described herein.

Section 12. This resolution, which takes effect immediately, shall be published in summary form in the official newspaper, together with a notice of the Town Clerk in substantially the form provided in Section 81.00 of the Local Finance Law.

The question of the adoption of the foregoing resolution was duly put to a vote on roll call, which resulted as follows:

George Woolsey, Councilman voting \_\_\_\_\_

Elizabeth J. Greene, Councilwoman voting \_\_\_\_\_

Paul I. Ruggiero, Councilman voting \_\_\_\_\_

Gilbert J. Piaquadio, Deputy Supervisor and Councilman voting \_\_\_\_\_

The resolution was thereupon declared duly adopted.

\* \* \* \* \*

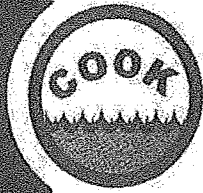

150

# Fred A. Cook, Jr. Inc.

SEWER, SEPTIC & PIPELINE CLEANING SPECIALISTS

P.O. BOX 70 MONTROSE, NY 10548

Website: [www.fredcook.com](http://www.fredcook.com)

Phone 914.739.3300  
845.739.3300  
Fax: 914.739.8525

December 23, 2014

Town of Newburgh  
1496 Route 300  
Newburgh, NY 12550  
Attn.: James Osborne, Engineering

To Whom It May Concern:

Fred A. Cook Jr. Inc. is working with GHD on the Meadow Hill South Sewer Inspection Project. This letter shall serve as our letter of commitment to perform our sewer cleaning and televising work during the period of March 2015 – May 2015 during / following wet weather.

Sincerely,

Brian F. Cook

CC: Joseph Dodd, P.E



Gil Piaquadio <councilmanpiaquadio@townofnewburgh.org>

**FW: MHS SSES**

1 message

Tue, Dec 23, 2014 at 9:36 PM

**James Osborne** <josborne1@hvc.rr.com>

To: councilmanpiaquadio@townofnewburgh.org

Cc: dpwcommissioner@townofnewburgh.org, Mark Taylor <MTaylor@riderweiner.com>

Gil,

Attached is the letter commitment GHD received from Fred Cook Co. regarding the Meadow Hill South SSES work. GHD was hoping for a more comprehensive letter, but Fred Cook appears to be committed to the work.

Based on your review of the attached letter, please consider putting this item on the agenda for the 29<sup>th</sup> meeting. GHD will need to gear up to catch the march to may window for excessive flows.

If you have any questions, you can reach me at this e-mail address.

Merry Christmas

Jim

---

**From:** Joseph Dodd [mailto:Joseph.Dodd@ghd.com]  
**Sent:** Tuesday, December 23, 2014 5:26 PM  
**To:** josborne1@hvc.rr.com; engineering@townofnewburgh.org  
**Cc:** Kevin Castro  
**Subject:** RE: MHS SSES

Jim,

I've struggled to get a commitment letter from Fred Cook. I don't believe it was because they were opposed to providing one, just due to their lack of responsiveness.

Attached is what they sent me today. I asked them to revise the letter to include the cost structure and their commitment to their quoted prices. I will forward the revised letter on to you as soon as I get it.

In speaking with Brian Cook, he is enthusiastic about doing the work and completing it for their quoted prices while meeting the schedule.

Please feel free to contact me. Have a great holiday!

Regards,

**Joseph Dodd, P.E.**  
Project Engineer

**GHD**

T: (315) 679-5780 | V: 865780 | F: (315) 679-5801 | E: joseph.dodd@ghd.com  
One Remington Park Drive, Cazenovia, NY 13035 USA | www.ghd.com

WATER | ENERGY & RESOURCES | ENVIRONMENT | PROPERTY & BUILDINGS | TRANSPORTATION

Please consider our environment before printing this email.

---

**From:** James Osborne [mailto:engineering@townofnewburgh.org]  
**Sent:** Thursday, December 11, 2014 9:22 AM  
**To:** Joseph Dodd  
**Cc:** Kevin Castro  
**Subject:** MHS SSES

Joe,

The Town Board was concerned about the potential spread of the costs for the subcontractor's work. Is it possible to get a letter of commitment from Fred Cook to lock in the lower costs. If we can get that, I think the Board is ready to approve the proposal. Let me know how you make out. Maybe we can get this on the agenda for Dec 29<sup>th</sup>.

FYI - I will be in the office until Dec 19 (AM only). If you need to communicate with me after that my personal e-mail is josborne1@hvc.rr.com.

Thanks

James W. Osborne  
Town Engineer  
1496 Route 300  
Newburgh, NY 12550  
engineering@townofnewburgh.org

845.564.7814 (tel)

845.566.1432 (fax)

---

This e-mail has been scanned for viruses

---

**CONFIDENTIALITY NOTICE:** This email, including any attachments, is confidential and may be privileged. If you are not the intended recipient please notify the sender immediately, and please delete it; you should not copy it or use it for any purpose or disclose its contents to any other person. GHD and its affiliates reserve the right to monitor and modify all email communications through their networks.

---

---

 **Commitment letter GHD.pdf**  
50K

## James Osborne

---

**From:** Joseph Dodd [Joseph.Dodd@ghd.com]  
**Sent:** Wednesday, December 24, 2014 11:36 AM  
**To:** James Osborne; engineering@townofnewburgh.org  
**Cc:** Kevin Castro  
**Subject:** RE: MHS SSES  
**Attachments:** Twn. of Nwbgh..pdf

Jim,

Here is their revised commitment letter with the cost structure included. I feel much more confident with this version. In case they're encountered, I had them add a line item for clearing intruding laterals, just so the price is known now. The cost for this would be covered with the contingency.

These prices are hard to beat, and they are also utilizing newer technology camera equipment which will be nice.

Let me know if you need anything else. Happy Holidays to you as well!

Regards,

**Joseph Dodd, P.E.**  
Project Engineer

**GHD**  
T: (315) 679-5780 | V: 865780 | F: (315) 679-5801 | E: [joseph.dodd@ghd.com](mailto:joseph.dodd@ghd.com)  
One Remington Park Drive, Cazenovia, NY 13035 USA | [www.ghd.com](http://www.ghd.com)

[WATER](#) | [ENERGY & RESOURCES](#) | [ENVIRONMENT](#) | [PROPERTY & BUILDINGS](#) | [TRANSPORTATION](#)

Please consider our environment before printing this email

---

**From:** James Osborne [mailto:[josborne1@hvc.rr.com](mailto:josborne1@hvc.rr.com)]  
**Sent:** Tuesday, December 23, 2014 9:40 PM  
**To:** Joseph Dodd  
**Subject:** RE: MHS SSES

Thanks Joe.

I have forwarded your e-mail to the Supervisor and asked him to consider placing the proposal back on the agenda. I will let you know what I hear if anything.

Happy Holidays.

Jim

**From:** Joseph Dodd [mailto:[Joseph.Dodd@ghd.com](mailto:Joseph.Dodd@ghd.com)]  
**Sent:** Tuesday, December 23, 2014 5:26 PM  
**To:** [josborne1@hvc.rr.com](mailto:josborne1@hvc.rr.com); [engineering@townofnewburgh.org](mailto:engineering@townofnewburgh.org)  
**Cc:** Kevin Castro  
**Subject:** RE: MHS SSES

Jim,

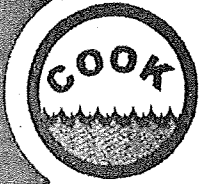

# Fred A. Cook, Jr. Inc.

SEWER, SEPTIC & PIPELINE CLEANING SPECIALISTS

P.O. BOX 70 MONTROSE, NY 10548

Website: [www.fredcook.com](http://www.fredcook.com)

Phone 914.739.3300  
845.739.3300  
Fax: 914.739.8525

December 23, 2014

Town of Newburgh  
1496 Route 300  
Newburgh, NY 12550  
Attn.: James Osborne, Engineering

To Whom It May Concern:

Fred A. Cook Jr. Inc. is working with GHD on the Meadow Hill South Sewer Inspection Project. This letter shall serve as our letter of commitment to perform our sewer cleaning and televising work during the period of March 2015 – May 2015 during / following wet weather, according to the cost structure outlined in our December 5, 2014 quote sent to GHD, and as shown below:

- Clean and televise approximately 25,000 LF of 8" – 10" sewer @ \$1.25 / LF.
- Televise approximately 100 laterals @ \$250.00 / each.
- Clear Intruding taps and laterals @ \$200.00 / each.

Sincerely,

Brian F. Cook

CC: Joseph Dodd, P.E





# TOWN OF NEWBURGH

DEPARTMENT OF PUBLIC WORKS  
DIVISION OF WATER AND SEWER  
311 ROUTE 32  
NEWBURGH, NY 12550

PHONE: 845-564-7813  
FAX: 845-566-8903

JOHN PLATT  
COMMISSIONER

To: Gil Piaquadio, Town Supervisor and Town Board Members

From: John Platt, Commissioner of Public Works

Date: December 23, 2014

Re: Budget Transfer

I respectfully request the following budget transfers to cover New York City Water cost for the end of the year.

	(Sludge Hauling/Disposal)	
Transfer from:	8330.0457.4002	\$ 20,000.00
	(Chemicals)	
	8330.0459.4002	\$ 20,000.00
	(Consultant Fees)	
	8330.0472.4002	\$ 40,000.00
	(Telemetry)	
	8330.0479.4002	\$ 15,000.00
	(Chemicals)	
	8330.0459.4001	\$ 35,000.00
	(Consultant Fees)	
	8330.0472.4001	\$ 55,000.00
	(NYC Water Cost)	
Transfer to:	8330.0430.4002	\$ 185,000.00

I am requesting that this item be placed on the December 29, 2014 agenda for approval. If you have any questions or comments, I am available for discuss them with you.

Thank you.

JP/mb



JOHN PLATT  
COMMISSIONER

# TOWN OF NEWBURGH

DEPARTMENT OF PUBLIC WORKS  
DIVISION OF WATER AND SEWER  
311 ROUTE 32  
NEWBURGH, NY 12550

PHONE: 845-564-7813  
FAX: 845-566-8903

To: Gil Piaquadio, Town Supervisor and Town Board Members

From: John Platt, Commissioner of Public Works

Date: December 23, 2014

Re: Inter-fund Transfer

---

Based on the need for water main improvements, I am requesting the Town approve an inter-fund transfer from the Water Funds to the Water Capital Project – Colden Park Improvements in the amount of \$200, 000.00. This inter-fund transfer is already budgeted for in the Water Fund's 2014 Adopted Budget.

I am requesting that this item be placed on the December 29, 2014 agenda for approval. If you have any questions or comments, I am available for discuss them with you.

Thank you.

JP/mb

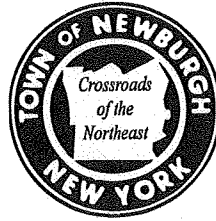

# HIGHWAY DEPARTMENT

90 GARDNERTOWN ROAD  
NEWBURGH, NEW YORK 12550

TELEPHONE 845-561-2177  
FAX 845-561-8987

TODD DEPEW  
HIGHWAY SUPERINTENDENT

**TO:** Gil Piaquadio, Acting Supervisor  
**FROM:** Todd DePew, Highway Superintendent  
**DATE:** December 23, 2014  
**RE:** Transfer Request

I would like to request the following budget transfer could you please put this on the agenda for the next meeting:

<b>FROM:</b>	<b>TO:</b>	<b>AMOUNT:</b>
030.5110.0497 General Repairs Maintenance Contracts/ Leases/Rentals	030.5110.0412 General Repairs Street Paving & Resurfacing	\$8,000.00

If you have any questions please feel free to contact me. Thank you.

**TD:ch**  
**cc:** R. Clum, Accounting  
J. Platt, DPW Commissioner

On a separate matter I am asking for the board to approve a new General Fund Capital Project- Various Paving and to authorize a transfer from Interfund Transfers (001-9902-0900) to (090-2801-9050) Capital Fund, Capital Projects-Variouse Paving, in the amount of \$19,000. This amount is to cover the Paving at Code (\$14,000) and Police (\$5,000).



# TOWN OF NEWBURGH

1496 Route 300, Newburgh, New York 12550

**RONALD E. CLUM, CPA**  
ACCOUNTANT

845-564-5220

Fax: 845-566-9461

E-Mail: [rclumaccountant@townofnewburgh.org](mailto:rclumaccountant@townofnewburgh.org)

**To:** Gil Piaquadio, Town Supervisor  
**CC:** Town Board  
**From:** Ronald E. Clum, Town Accountant   
**Date:** December 29, 2014  
**RE:** Budget Transfer and Money Transfer

---

Upon discussion with John Platt and Todd DePew we have not yet purchased the Vector Truck (\$375,115) and the Class 8 truck (\$179,185). The Vector truck was budgeted under the Highway, Water, and Sewer Funds. With regards to this item I am asking for the following two items to be added to the December 29, 2014 board minutes related to this transaction.

1. At this time I am requesting that budget transfers be made from the equipment accounts to the respective interfund transfer accounts:

Equipment Exp	Interfund Transfer	Amount
030.5130.0200	030.9902.0900	\$304,940
040.8340.0200	040.9902.0900	\$125,000
050.8130.0200.5001	050.9902.0900.5001	\$2,082
050.8130.0200.5003	050.9902.0900.5003	\$15,446
050.8130.0200.5004	050.9902.0900.5004	\$7,504
050.8130.0200.5005	050.9902.0900.5005	\$931
050.8130.0200.5006	050.9902.0900.5006	\$6,118
050.8130.0200.5007	050.9902.0900.5007	\$4,604
050.8130.0200.5008	050.9902.0900.5008	\$1,474
050.8130.0200.5009	050.8130.0200.5009	\$1,095
050.8130.0200.5010	050.8130.0200.5010	\$85,106

2. Upon approval of these budget transfers I am asking to transfer the money from the above interfund transfer lines to the Capital Fund for the purchase of these two trucks.

P.O. BOX 453  
 WALDEN, NEW YORK  
 12586

PHONE 845-778-6565  
 FAX 845-778-6560

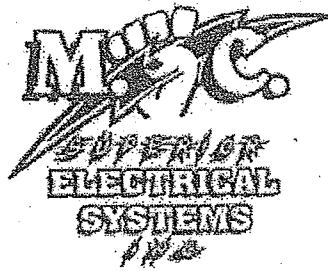

# Estimate

Date	Estimate #
11/3/2014	1944

Name / Address
TOWN OF NEWBURGH 1496 RTE. 300 NEWBURGH, NY 12550

Terms
Net 30

Description	Total
" VERMONT & MAINE - LIGHTING UPGRADES "	
THE FOLLOWING PRICE QUOTE IS FOR :	
- REPLACING THE EXISTING 70 WATT HIGH PRESSURE SODIUM POLE LIGHT HEADS WITH A NEW 100 WATT METAL HALIDE POLE LIGHT HEAD WITH BUILT IN PHOTOCELL (SIMILAR IN APPEARANCE) - COORDINATE WITH CENTRAL HUDSON TO DISCONNECT & RECONNECT THE POLES AS WE WORK ON THEM. POLES WILL BE ENERGIZED DAILY - REPLACE HEADS WITH THE USE OF A BUCKET TRUCK, AND A CREW OF TWO MEN - PRICE IS PER POLE.	805.00
*** ADD ALTERNATE : UPGRADE THE NEW HEAD TO A 20 WATT LED HEAD WITH BUILT IN PHOTOCELL, SIMILAR IN APPEARANCE TO THE EXISTING. TOTAL ADDED = \$280.00 Sales Tax	0.00

Thank you for the opportunity to bid on this job.	<b>Total</b>	\$805.00
---	--------------	----------

Pricing for the above Estimate is valid for 30 days.

Signature \_\_\_\_\_

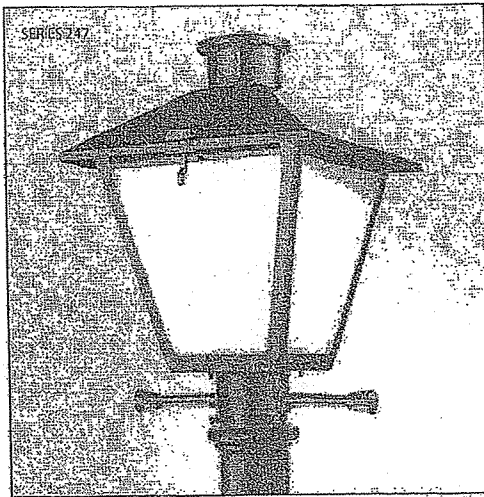

**Features:**

- Die-cast aluminum housing and hood for long-life performance
- Die-cast trigger latch (TL) option available for easy access to internal components.
- Optical assembly designed for maximum performance
- Hinged hood and captive screw provision afford quick, easy access to electrical and optical area for relamping or servicing
- Slipfitter with three set screws allows secure installation to pole sizes 2-3/8" or 3" O.D.
- E39 mogul-base socket standard
- All electrical components warranted by American Electric Lighting's 6-year guarantee
- Complies with ANSI: C136.2, C136.10, C136.15, C136.31 (regular only), C136.16 (FC only)
- Suitable for +30°C MH & / -40°C HPS

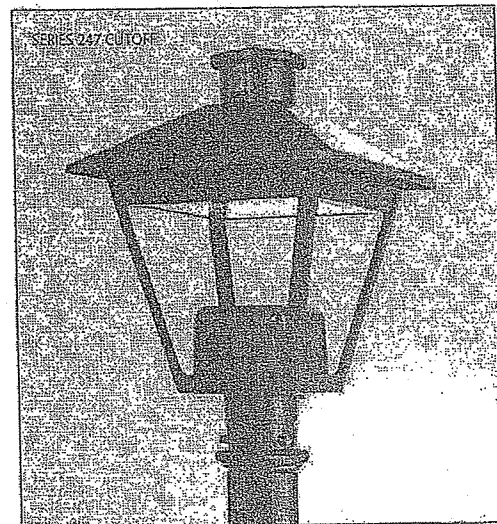

**Applications:**

- Streetscapes
- Walkways
- Pathways
- Parks

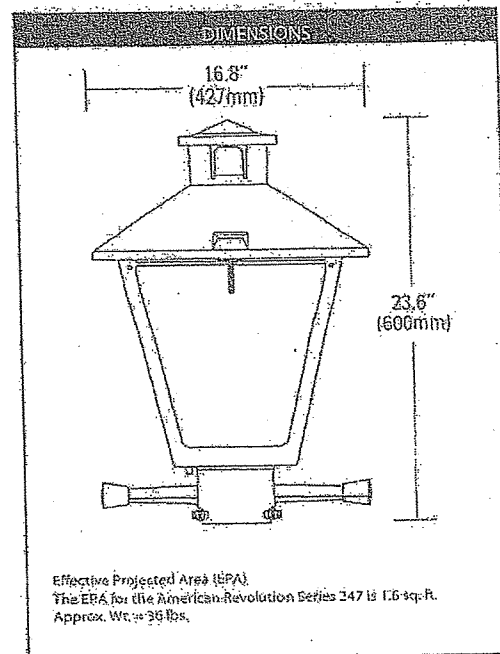

**PREFERRED SELECTION CATALOG NUMBERS:**

Series 247

- 247 10S RN 120 R3 AY
- 247 15S RN 120 R3 AY
- 247 10S RN 120 R5 AY
- 247 15S RN 120 R5 AY

Series 247 Cutoff

- 247 10S RN 120 R2 FC TL
- 247 10M XN MT1 R2 FC TL

Decorative

Sheet # DL-247-A



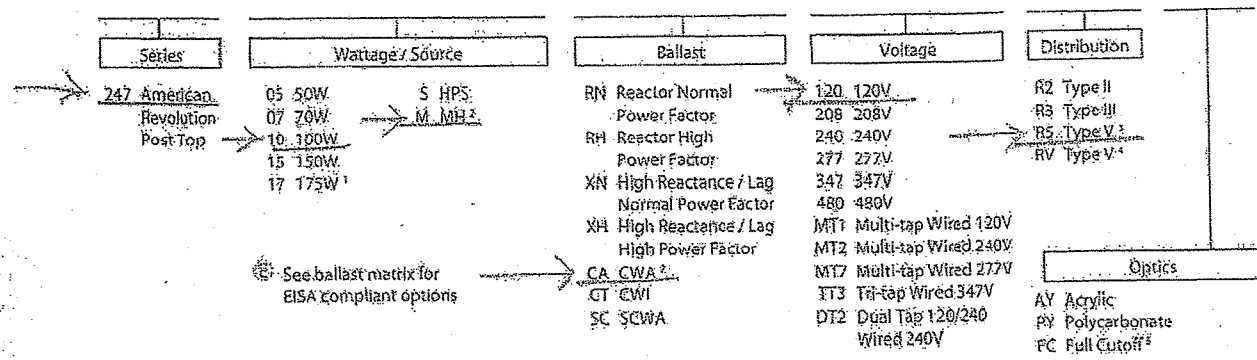

Options

<b>Paint</b> <sup>1</sup>	<b>Lamp</b>
(blank) Black (standard)	LC Lamp Included, Clear
BZ Bronze	LD Lamp Included, Deluxe/Coated
DBB Dark Bronze	
GY Gray	<b>Starter</b> <sup>10</sup>
WP White	(blank) Open Board (standard)
	EC Encapsulated Plug-in
<b>Terminal Block</b>	OP Open Plug-in
(blank) Terminal Block (standard)	
T2 Wired to L1 & L2 Position	<b>Misc.</b>
T3 3 Wire Operation (L1, N, L2 Position) <sup>7</sup>	PC Photocontrol Included per Voltage Specified <sup>8</sup>
	SH Shoring Cap <sup>9</sup>
<b>Listing</b>	SS Stainless Steel Hardware
UL UL Listed	NE NEMA Label (2x2)
CS CSA Certified	H5 House Side Shield <sup>11</sup>
	TE Tool-less Entry
<b>Fusing</b> <sup>6</sup>	LDR Ladder Rest <sup>12</sup>
SF Single Fuse (120, 277, 347V)	
DF Double Fuse (208, 240, 480V)	
<b>Photocontrol Receptacle</b>	
(blank) NEMA Photocontrol Receptacle (standard)	
NR No Photocontrol Receptacle <sup>8</sup>	

Notes:

- 1 When ordered with metal halide, these wattages do not comply with California Title 20 regulations.
- 2 CA ballast is not available with 175W - 400W metal halide in the U.S.; must use SC
- 3 Four white panels
- 4 Four clear panels
- 5 Nighttime Friendly<sup>SM</sup> optic; consult factory for distribution availability
- 6 Other colors available, please contact your local American Electric Lighting representative
- 7 T3 option only available with 240, 480; DT2, DT4, MT2
- 8 Not available in MT, TE, DT voltages; voids UL listing
- 9 PC and SH not available with NR option
- 10 HPS only
- 11 Acrylic only, Not available with FC version
- 12 Ships with unit, field installed

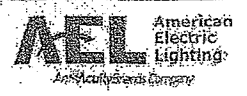

American Electric Lighting  
Acuity Brands Lighting, Inc.  
3825 Columbus Rd. S.W., Granville, OH 43023  
Phone: 800-537-5730, Fax: 740-587-6114  
www.americanelectrlighting.com



Series 247

Watts	120	200	240	277	347	480	DT2
055	RH, RN						
075	CA, MR, RH, RN, XH, XN	CA, XH, XN	CA, MR, XH, XN	CA, XH, XN		XH, XN	CA, MR, XH, XN
075	XH, XN	XH, XN	XH, XN	XH, XN			
105	CA, CT, MR, RH, RN, XH, XN	CA, CT, XH, XN	CA, CT, MR, XH, XN	CA, CT, XH, XN		CA	MR, XH, XN
105	CA, XH, XN	XH, XN	XH, XN	CA, XH, XN	XH, XN	XH, XN	CA, XH, XN
135	RH						
145	RN						
155	CA, CT, RH, RN, XH, XN	CA, CT, XH, XN	CA, CT, XH, XN	CA, CT, XH, XN	XH, XN	CA	CA, CT, XH, XN
155	XH, XN	XH, XN	XH, XN	XH, XN			
175	SC	SC	SC	SC			SC

Series 247 continued

Watts	075	105	135	175
055				
075	CA, XH, XN	CA, XH, XN	CA, XH, XN	
075	XH, XN	XH, XN	XH, XN	
105	CA, CT, XH, XN	CA, CT, XH, XN	CA, CT, XH, XN	
105	XH, XN	XH, XN	XH, XN	XH, XN
135				
145				
155	CA, CT, XH, XN	CA, CT, XH, XN	CA, CT, XH, XN	XH, XN
155	XH, XN	XH, XN	XH, XN	
175	SC	SC	SC	

PHOTOMETRICS

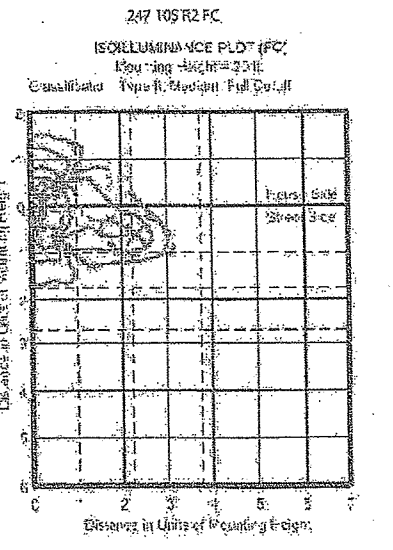
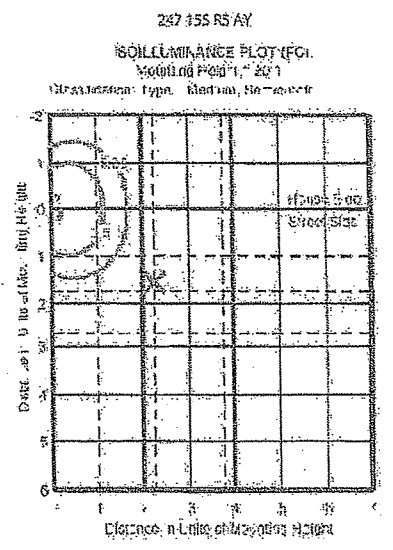
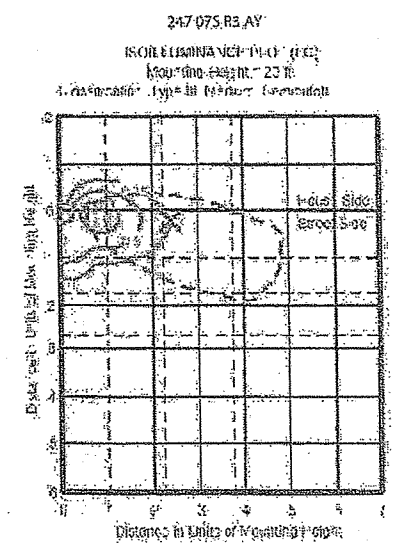

X Maximum Intensity  
1/2 Maximum Intensity

Decorative

Sheet # DL-247-A

**AEL** American Electric Lighting

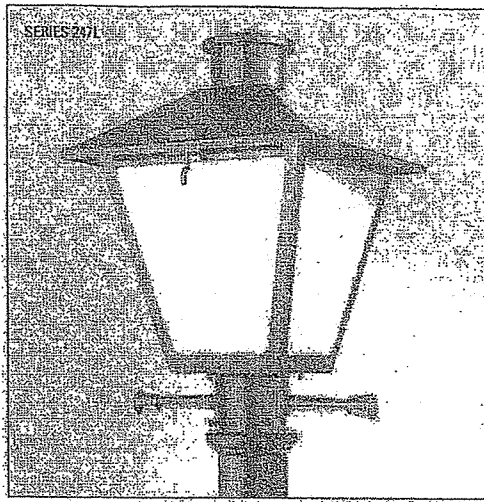

### Features:

- Die-cast aluminum housing and hood for long-life performance
- Die-cast trigger latch (TL) and captive thumb screws option available for easy access to internal components
- Optical assembly designed for maximum performance, available in Type II, Type III and Type V
- Hinged hood and captive thumb screws provision afford quick, easy access to electrical and optical area for servicing.
- Slipfitter with three set screws allows secure installation to pole sizes 2-3/8" or 3" O.D.
- Complies with ANSI: C136.2, C136.10, C136.15
- CSA listed and suitable for up to 30°C ambient
- Rated L70, LED life greater than 100,000 hours at 25°C
- Replaces up to 150W HPS light source incumbent models

### Applications:

Streetscapes  
Walkways  
Pathways  
Parks

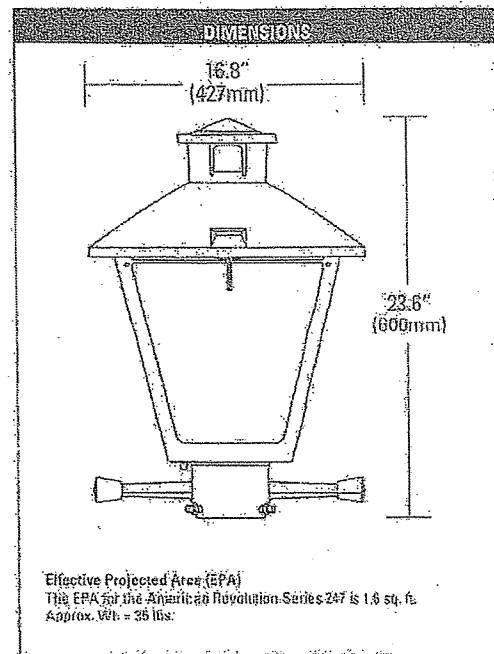

Series	Performance Package	Voltage	Color Temperature (CCT)
247L American Revolution LED	20LEDE10 20 Chips, 1050 mA Driver, 72 input watts	MVOLT Multi-volt, 120-277V	3K 3000K
	20LEDE70 20 Chips, 700 mA Driver, 45 input watts	347 347V	4K 4000K
	10LEDE10 10 Chips, 1050 mA Driver, 38 input watts	480 480V	5K 5000K
	10LEDE70 10 Chips, 700 mA Driver, 25 input watts		
	10LEDE53 10 Chips, 525 mA Driver, 18 input watts		
	10LEDE35 10 Chips, 350 mA Driver, 13 input watts		

Distribution	Optics	Options
R2 Type II	AY Acrylic	Paint <sup>1</sup>
R3 Type III	PY Polycarbonate	(blank) Black (standard)
R5 Type V		GY Gray
		DBB Dark Bronze
		WH White
		BZ Bronze
		Photocontrol
		(blank) NEMA Photocontrol
		Receptacle (standard)
		NR <sup>2</sup> No Photocontrol Receptacle
		Miscellaneous
		PCSS <sup>3,4</sup> Solid State Lighting Photocontrol (120-277V)
		PGLI <sup>1,6</sup> Solid State Long Life Photocontrol
		SS Stainless steel hardware
		NL NEMA Label
		XL Not CSA Listed
		TL Tool-less Entry
		LDR <sup>2</sup> Ladder Rest
		SH Shorting Cap
		DE <sup>4</sup> ROAM Dimming Enabled
		DM DMV-10V dimmable driver only (leads attached)
		HSSB House Side Shield Black
		HSSW House Side Shield White
		CR Enhanced Corrosion Resistant Finish

Notes:

1. Other colors available; please contact factory
2. PG and SH not available with NR option
3. Ships with unit, field installed
4. Standard failure mode = "Fail Off"
5. Photocontrols supplied with ANSI Standard Turn-On levels
6. Specifies a ROAM dimming enabled fixture with a dimming control module factory installed, NEMA photocontrol receptacle required. Additional hardware and services required, ROAM deployment must be purchased separately.



©2014 Acuity Brands Lighting, Inc. 7/14

American Electric Lighting  
 Acuity Brands Lighting, Inc.  
 3925 Columbus Rd., S.W., Greenville, OH 45903  
 Phone: 800-754-4663 Fax: 937-249-1490  
 www.americanelectriclighting.com

DLC products are listed in BOLD  
 Non DLC products are indicated by shaded box

LED Quantity, mA, CCT	Input Watts	TOTAL LUMENS					
		R2-AY	R3-AY	R5-AY	R2-PV	R3-PV	R5-PV
<b>20LEDE10 3k</b>	72	<b>5805</b>	<b>3585</b>	<b>3930</b>	<b>3289</b>	<b>3364</b>	<b>3688</b>
<b>20LEDE10 4k</b>	72	<b>4909</b>	<b>4510</b>	<b>4944</b>	<b>4135</b>	<b>4230</b>	<b>4637</b>
<b>20LEDE10 5k</b>	72	<b>4763</b>	<b>4862</b>	<b>5329</b>	<b>4458</b>	<b>4560</b>	<b>4998</b>
<b>20LEDE70 3k</b>	45	<b>2690</b>	<b>2751</b>	<b>3016</b>	<b>2522</b>	<b>2580</b>	<b>2828</b>
<b>20LEDE70 4k</b>	45	<b>3395</b>	<b>3473</b>	<b>3807</b>	<b>3170</b>	<b>3234</b>	<b>3554</b>
<b>20LEDE70 5k</b>	45	<b>3660</b>	<b>3743</b>	<b>4103</b>	<b>3417</b>	<b>3495</b>	<b>3839</b>
<b>10LEDE10 3k</b>	36	<b>1800</b>	<b>1849</b>	<b>2027</b>	<b>1741</b>	<b>1780</b>	<b>1916</b>
<b>10LEDE10 4k</b>	36	<b>2293</b>	<b>2345</b>	<b>2571</b>	<b>2152</b>	<b>2201</b>	<b>2412</b>
<b>10LEDE10 5k</b>	36	<b>2469</b>	<b>2526</b>	<b>2768</b>	<b>2319</b>	<b>2372</b>	<b>2600</b>
<b>10LEDE70 3k</b>	25	<b>1367</b>	<b>1398</b>	<b>1509</b>	<b>1307</b>	<b>1330</b>	<b>1458</b>
<b>10LEDE70 4k</b>	25	<b>1762</b>	<b>1804</b>	<b>1977</b>	<b>1636</b>	<b>1673</b>	<b>1834</b>
<b>10LEDE70 5k</b>	25	<b>1896</b>	<b>1939</b>	<b>2126</b>	<b>1764</b>	<b>1804</b>	<b>1977</b>
<b>10LEDE53 3k</b>	18	<b>1067</b>	<b>1086</b>	<b>1216</b>	<b>1019</b>	<b>1042</b>	<b>1142</b>
<b>10LEDE53 4k</b>	18	<b>1085</b>	<b>1109</b>	<b>1233</b>	<b>1029</b>	<b>1038</b>	<b>1134</b>
<b>10LEDE53 5k</b>	18	<b>1473</b>	<b>1505</b>	<b>1654</b>	<b>1380</b>	<b>1412</b>	<b>1547</b>
<b>10LEDE35 3k</b>	13	<b>780</b>	<b>798</b>	<b>876</b>	<b>732</b>	<b>749</b>	<b>821</b>
<b>10LEDE35 4k</b>	13	<b>979</b>	<b>1001</b>	<b>1097</b>	<b>922</b>	<b>942</b>	<b>1033</b>
<b>10LEDE35 5k</b>	13	<b>1058</b>	<b>1082</b>	<b>1186</b>	<b>992</b>	<b>1015</b>	<b>1112</b>

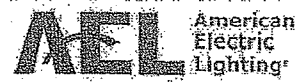

©2014 Acuity Brands Lighting, Inc. 7/14

American Electric Lighting  
 Acuity Brands Lighting, Inc.  
 3825 Columbus Rd. S.W., Granville, OH 43023  
 Phone: 800-754-9463 Fax: 740-349-4460  
[www.americanelectriclighting.com](http://www.americanelectriclighting.com)



# Invoice

**CIT-e-NET, LLC**  
1395 Rt 23 South - Suite #6  
Butler, NJ 07405

INVOICE NO. NBGTWN2014  
INVOICE DATE 08/27/2014  
CUSTOMER ORDER NO. web site renewal

SOLD TO:  
Township of Newburgh  
1496 Rt 300 North  
Newburgh, NY 12550

SHIPPED TO:  
Same

## 2014 / 2015 Subscription Renewal

QUANTITY	UNIT	DESCRIPTION	UNIT PRICE	AMOUNT
1	Annual	Subscription Period 9/9/14 through 9/8/15:		
		Base Web Site Service Application	\$3,000.00	\$3,000.00
1	Annual	Preview & Authorize Module	Special-Offer	Special-Offer
SUBTOTAL				\$3,000.00
TAX				N/A
<b>TOTAL</b>				<b>\$3,000.00</b>

**MAKE ALL CHECKS PAYABLE TO:**

Cit-e-Net, LLC  
1395 Rt 23 South - Suite #6  
Butler, NJ 07405

For Invoice Questions  
Please Call Bill Benzie 201-755-6570

*Thank You for Being a Client!*

19A



**TOWN OF NEWBURGH ANIMAL CONTROL & SHELTER**

645 Gidney Ave. Newburgh, NY 12550

To: Town Board  
From: Chantel Haight, Animal Control Supervisor  
Date: December 16, 2014  
Subject: Authorization to Pay Veterinarian Services Utilizing T-94 Account

I am requesting authorization to use the T-94 account to pay for veterinary services from Flannery Animal Hospital totaling \$374.10.

Attached please find the bills.

Thank you.

Cc: Ron Clum, accountant







789 Little Britain Rd  
 New Windsor, NY 12553  
 845-565-7387

**Dennis Forneris (# 36158)**  
 150 Vails Gate Hts Drive  
 New Windsor, NY 12553

**Nov 14, 2014**  
**Invoice Number**  
**171141**

Home Phone: (914) 489-9310  
 Work Phone: ( ) - ext:

**Lola (# D)** FVRCP Vaccine Booster: 11/14/2015  
 Species: Feline  
 Sex: Female Spayed  
 Age: 6 months old  
 Breed: Domestic Short Hair  
 Coat Color: Torti  
 Rabies Tag Number:

Date	Description	Qty	Price
11/14/2014	Office Visit - Medical Progress Exam	1.00	\$
	Nail Trim	1.00	\$
	FVRCP 1 year Vaccine	1.00	\$ <del>35.00</del> 28.00
	Estimate Given to client	1.00	\$ 0.00

Dr. Laura Jaworski

**Total for Lola:** \$  
**Total Products:** \$  
 Sales Tax: \$  
**Total Invoice:** \$  
**Previous Balance:** \$ 0.00  
**Total Amount Due:** \$  
 Visa(9207) \$  
**Total Payments - Thank you:** \$  
**New Balance Due:** \$ 28.00

19B



**TOWN OF NEWBURGH ANIMAL CONTROL & SHELTER**

645 Gidney Ave. Newburgh, NY 12550

To: Town Board  
From: Chantel Haight, Animal Control Supervisor  
Date: December 11, 2014  
Subject: Authorization to Pay Veterinarian Services Utilizing T-94 Account

I am requesting authorization to use the T-94 account to pay for veterinary services from Newburgh Veterinary Hospital for Canines and Felines for September, October and November totaling \$3880.42.

Canine: 2178.35  
Feline: 1702.17

Attached please find the bills.

Thank you.

Cc: Ron Clum, Accountant



# INVOICE

## Newburgh Veterinary Hospital

1716 Route 300  
Newburgh, NY 12550  
845 564-2660

"Your pet is part of our family too." Visit us at [www.newburghvet.com](http://www.newburghvet.com)

**FOR:** Town of Newburgh - Feline  
645 Gidney Ave.  
Newburgh, NY 12550  
(845) 561-3344

**Printed:** 11-28-14 at 11:40a  
**Date:** 09-29-14  
**Account:** 4417  
**Invoice:** 584528

Date	For	Qty	Description	Price	Discount	Net Price	
09-24-14	105K-14 Queen B	1	FeLV/FIV ELISA in hosp	73.00	36.50	36.50	** ✓
09-25-14		0.06	Morphine Inject Control Log / ml			0.00	
09-25-14		0.03	Telazol Injectable Control Log / ml			0.00	
09-25-14		1	OHE FELINE	139.50	69.75	69.75	** ✓
Your pet has been spayed. This eliminates the risk of uterine infection and lowers the risk of breast tumors when she gets older. Expect her to be quiet and not as active for a couple of days. Restrict exercise for the next two weeks. This receipt certifies that your pet has been spayed. Please keep this with your pet's health records.							
09-25-14		1	-Isoflurane Gas Anesthesia			0.00	
09-25-14		1	HERNIA addit'l during OHE/neuter	139.50	69.75	69.75	** ✓
09-25-14		1	Feline rabies 1yr	29.00	14.50	14.50	** ✓
Today, your cat received the most advanced rabies protection available. PUREVAX Rabies vaccine gives your cat protection that is pure, safe and effective without the use of potentially harmful adjuvants.							
09-25-14		1	FELINE RHINO/PANLEUK/CALICI	25.00	12.50	12.50	** ✓
Your pet has been immunized against feline distemper, rhinotracheitis, and calicivirus. Occasionally listlessness, lethargy, or lack of appetite may occur. If severe listlessness or facial swelling occurs, please call us for advice.							
09-25-14		1	CONSULT / EXAM - Annual Welln	49.50	24.75	24.75	** ✓
09-25-14		1	BOARD/FELINE Single Occupanc	15.00	7.50	7.50	** ✓
09-18-14	5th Ave Kittens	1	Tobramycin Ophthalmic Suspensic	32.45	16.23	16.22	** ✓
09-18-14		1	Flurbiprofen ophthalmic solution #1	23.00	11.50	11.50	** ✓
09-18-14		5	Strongid deworming(roundworms,t	87.00	43.50	43.50	** ✓
09-18-14		5	Zoonoses			0.00	
Discussed Zoonotic potential of intestinal parasites- in particular roundworms.							
09-18-14		1.25	Capstar administration	6.25	3.13	3.12	** ✓
09-18-14		4	Blood Draw Fee	60.00	30.00	30.00	** ✓
09-18-14		1	FeLV/FIV ELISA in hosp	73.00	36.50	36.50	** ✓
09-18-14		1	CONSULT / EXAM - Sick	59.50	29.75	29.75	** ✓
09-18-14		1	Pet Insurance Review			0.00	

Please visit [www.petinsurancereview.com](http://www.petinsurancereview.com) and [dogtime.com](http://dogtime.com) for an independent

review of all national pet health insurance plans

09-18-14		1	NYS Mandated Biological Waste	6.00	3.00	3.00	**
09-19-14		9	Shelter board feline med alert	175.50	175.50	0.00	**
09-22-14		1	FECAL (ParasiteScreen) T808	29.50	14.75	14.75	**
09-22-14		1	No Ova Seen			0.00	
09-22-14		1	Erythromycin Ophthalmic Ointment	37.50	18.75	18.75	**
09-22-14		1	Lysine/Duralactin Dose Syringe	27.50	13.75	13.75	**
09-25-14		1	Flurbiprofen ophthalmic solution	23.00	11.50	11.50	**
09-28-14		1	Flurbiprofen ophthalmic solution	23.00	11.50	11.50	**
09-29-14		1	Lysine/Duralactin Dose Syringe #1	27.50	13.75	13.75	**
09-29-14		1	Erythromycin Ophthalmic Ointment	37.50	18.75	18.75	**
09-24-14	Maney strays	0.04	Morphine Inject Control Log / ml			0.00	
09-24-14		0.05	Telazol Injectable Control Log / ml			0.00	
09-24-14		1	HERNIA/UMBILICAL	449.50	379.75	69.75	**
09-24-14		1	ANESTHESIA -Isoflurane	179.50	89.75	89.75	**
09-24-14		1	---BloodPressureMonitoring w/anes			0.00	
09-24-14		1	---PulseOximeterMonitoring w/Anes			0.00	
09-24-14		1	-CapnographMonitoring w/Anesthe			0.00	
09-24-14		1	-----Recovery in Heated Cage			0.00	
09-24-14		1	-----Warm Water Blanket in Surgery			0.00	
09-24-14		1	---Injectable Anesthetic Induction			0.00	
09-24-14		1	--Injection-Preanesthetic			0.00	

Total charges, this invoice... 671.09

\*\*Total discount included: 1156.61

Your invoice total reflects our **13Stray Cat Accounts** discount.

LIKE US ON FACEBOOK.COM!

GOING AWAY?...BOOK YOUR PETS BOARDING RESERVATION TODAY!

In compliance with New York State law, all medications are non-refundable. We regret any inconveniences.

# INVOICE

## Newburgh Veterinary Hospital

1716 Route 300  
Newburgh, NY 12550  
845 564-2660

"Your pet is part of our family too." Visit us at [www.newburghvet.com](http://www.newburghvet.com)

**FOR:** Town of Newburgh - Feline  
645 Gidney Ave.  
Newburgh, NY 12550  
(845) 561-3344

**Printed:** 11-28-14 at 11:41a  
**Date:** 10-10-14  
**Account:** 4417  
**Invoice:** 585284

Date	For	Qty	Description	Price	Discount	Net Price
10-08-14	105K-14 Queen B	1	Suture Removal			0.00
10-06-14	5th Ave Kittens	1	Consult exam litter (4 or more kittens)	125.00	62.50	62.50 **
10-06-14		1	Miconazole Lotion #188530	31.20	15.60	15.60 **
10-06-14		5	Feline Rhino/Panleuk/Calici #1	125.00	62.50	62.50 **
	Your cat has received the first in a series of immunizations to protect him/her against feline distemper, rhinotracheitis, and calicivirus. It is important to return for a followup booster in 3-4 weeks. Occasionally listlessness, lethargy, or localized discomfort may occur. If there is severe listlessness or facial swelling, please call us for advice.					
10-06-14		5	Recommend Fecal (please dropoff)			0.00
	Annual fecal microscopic exams are very important for the health of your pet and, since some worms are transmissible to humans, for the health of your family. Please bring us your pet's fecal sample at your earliest convenience					
10-06-14		5	Zoonoses			0.00
	Discussed Zoonotic potential of intestinal parasites- in particular roundworms.					
10-06-14		5	Strongid Deworming-Roundworms	90.00	45.00	45.00 **
10-08-14	Butter	1	FeLV/FIV ELISA in hosp	73.00	36.50	36.50 **
10-08-14		1	CONSULT / EXAM - Annual Welln	49.50	24.75	24.75 **
10-08-14		1	Amoxicillin Drops 15ml (50mg/ml)	15.00	7.50	7.50 **
10-10-14	Skeeter 68C-14	1	CONSULT / EXAM - Sick	59.50	29.75	29.75 **
10-10-14		1	Shelter euthanasia and body care f			65.00
10-10-14		1.50	EUTHANASIA - SOMLETHOL PEN			0.00
10-10-14		1	Pet Insurance Review			0.00
	Please visit <a href="http://www.petinsurancereview.com">www.petinsurancereview.com</a> and <a href="http://dogtime.com">dogtime.com</a> for an independent review of all national pet health insurance plans					
10-10-14		1	NYS Mandated Biological Waste	6.00	3.00	3.00 **

Total charges, this invoice... 352.10

\*\*Total discount included: 287.10

*AS per 12-11-14*

Your invoice total reflects our **13Stray Cat Accounts** discount.

Reminders for: <b>Butter</b> (Weight: 4.1 lbs - 17w)		Last done
11/15	CONSULT/EXAM - Annual Wellness	11-22-14
05/15	FECAL EXAM	11-20-14
12/14	Rhinotracheitis/Pan/leuk/Calic	
11/14	Rabies/Purevax Feline 1yr	

**Butter's weight history** (in lbs)

---

11-22-14	4.10
----------	------

---

LIKE US ON FACEBOOK.COM!

GOING AWAY?...BOOK YOUR PETS BOARDING RESERVATION TODAY!

In compliance with New York State law, all medications are non-refundable. We regret any inconveniences.

# INVOICE

## Newburgh Veterinary Hospital

1716 Route 300  
Newburgh, NY 12550  
845 564-2660

"Your pet is part of our family too." Visit us at [www.newburghvet.com](http://www.newburghvet.com)

**FOR:** Town of Newburgh - Feline  
645 Gidney Ave.  
Newburgh, NY 12550  
(845) 561-3344

**Printed:** 11-28-14 at 11:41a  
**Date:** 10-17-14  
**Account:** 4417  
**Invoice:** 585781

Date	For	Qty	Description	Price	Discount	Net Price
10-16-14	110C-14 Fergie	1	FeLV/FIV ELISA in hosp	73.00	36.50	36.50 **
10-15-14	Butter	1	NEUTER/FELINE	51.50	25.75	25.75 **
10-15-14		1	Feline Rhino/Panleuk/Calici #1	25.00	12.50	12.50 **
Your cat has received the first in a series of immunizations to protect him/her against feline distemper, rhinotracheitis, and calicivirus. It is important to return for a followup booster in 3-4 weeks. Occasionally listlessness, lethargy, or localized discomfort may occur. If there is severe listlessness or facial swelling, please call us for advice.						
10-15-14		1	Recommend Fecal (please dropoff)			0.00
Annual fecal microscopic exams are very important for the health of your pet and, since some worms are transmissible to humans, for the health of your family. Please bring us your pet's fecal sample at your earliest convenience						
10-15-14		1	Zoonoses			0.00
Discussed Zoonotic potential of intestinal parasites- in particular roundworms.						
10-15-14		0.04	Telazol Injectable Control Log / ml			0.00
Total charges, this invoice...						74.75
**Total discount included: 74.75						

Your invoice total reflects our **13Stray Cat Accounts** discount.

Reminders for:	Butter (Weight: 4.1 lbs - 17w)	Last done
11/15	CONSULT/EXAM - Annual Wellness	11-22-14
05/15	FECAL EXAM	11-20-14
12/14	Rhinotracheitis/Pan/leuk/Calic	
11/14	Rabies/Purevax Feline 1yr	

### Doctor's Instructions



# INVOICE

## Newburgh Veterinary Hospital

1716 Route 300  
Newburgh, NY 12550  
845 564-2660

"Your pet is part of our family too." Visit us at [www.newburghvet.com](http://www.newburghvet.com)

**FOR:** Town of Newburgh - Feline  
645 Gidney Ave.  
Newburgh, NY 12550  
(845) 561-3344

**Printed:** 11-28-14 at 11:42a  
**Date:** 10-20-14  
**Account:** 4417  
**Invoice:** 586016

Date	For	Qty	Description	Price	Discount	Net Price
			Total charges, this invoice...			0.00
			Total payment(s) received...			36.50
			10-20-14 Cash payment		36.50	

LIKE US ON FACEBOOK.COM!

GOING AWAY?...BOOK YOUR PETS BOARDING RESERVATION TODAY!

In compliance with New York State law, all medications are non-refundable. We regret any inconveniences.

# INVOICE

**Newburgh Veterinary Hospital**

1716 Route 300  
 Newburgh, NY 12550  
 845 564-2660

"Your pet is part of our family too." Visit us at [www.newburghvet.com](http://www.newburghvet.com)

**Printed:** 11-28-14 at 11:42a  
**Date:** 10-21-14  
**Account:** 4417  
**Invoice:** 586083

**FOR:** Town of Newburgh - Feline  
 645 Gidney Ave.  
 Newburgh, NY 12550  
 (845) 561-3344

Date	For	Qty	Description	Price	Discount	Net Price
10-20-14	Kittens 10/20/1	1	FelV/FIV ELISA in hosp	73.00	36.50	36.50 **
10-20-14		3	Blood Draw Fee	45.00	22.50	22.50 **
10-20-14		3	Feline Rhino/Panleuk/Calici #1	75.00	37.50	37.50 **
Your cat has received the first in a series of immunizations to protect him/her against feline distemper, rhinotracheitis, and calicivirus. It is important to return for a followup booster in 3-4 weeks. Occasionally listlessness, lethargy, or localized discomfort may occur. If there is severe listlessness or facial swelling, please call us for advice.						
10-20-14		3	RecommendFecal (please dropoff Annual fecal microscopic exams are very important for the health of your pet and, since some worms are transmissible to humans, for the health of your family. Please bring us your pet's fecal sample at your earliest convenience			0.00
10-20-14		3	Zoonoses Discussed Zoonotic potential of intestinal parasites- in particular roundworms.			0.00
10-17-14	Strays	1	Feline rabies/Purevax 1yr Today, your cat received the most advanced rabies protection available. PUREVAX Rabies vaccine gives your cat protection that is pure, safe and effective without the use of potentially harmful adjuvants.  for "Cocoa" Gerow	29.00	14.50	14.50 **

Total charges, this invoice... 111.00

\*\*Total discount included: 111.00

Your invoice total reflects our **13Stray Cat Accounts** discount.

Reminders for:	Strays	Last done
10/15	Rabies/Purevax Feline 1yr	10-17-14

# INVOICE

## Newburgh Veterinary Hospital

1716 Route 300  
Newburgh, NY 12550  
845 564-2660

"Your pet is part of our family too." Visit us at [www.newburghvet.com](http://www.newburghvet.com)

**FOR:** Town of Newburgh - Feline  
645 Gidney Ave.  
Newburgh, NY 12550  
(845) 561-3344

**Printed:** 11-28-14 at 11:43a  
**Date:** 10-24-14  
**Account:** 4417  
**Invoice:** 586264

Date	For	Qty	Description	Price	Discount	Net Price
			Total charges, this invoice...			0.00
			Total payment(s) received...			130.00
			10-24-14 Visa payment	130.00		

Merchant ID: 529000046758, Approval code: , Transaction ID:

Ref #: , Act #: , Exp: XX/XX, Entry: , Card: VISA

Your card balance is not available

I AGREE TO PAY ABOVE TOTAL AMOUNT ACCORDING TO CARD ISSUER AGREEMENT

X \_\_\_\_\_

LIKE US ON FACEBOOK.COM!

GOING AWAY?....BOOK YOUR PETS BOARDING RESERVATION TODAY!

In compliance with New York State law, all medications are non-refundable. We regret any inconveniences.

# INVOICE

## Newburgh Veterinary Hospital

1716 Route 300  
Newburgh, NY 12550  
845 564-2660

"Your pet is part of our family too." Visit us at [www.newburghvet.com](http://www.newburghvet.com)

**FOR:** Town of Newburgh - Feline  
645 Gidney Ave.  
Newburgh, NY 12550  
(845) 561-3344

**Printed:** 11-26-14 at 11:49a  
**Date:** 10-29-14  
**Account:** 4417  
**Invoice:** 586691

Date	For	Qty	Description	Price	Discount	Net Price
10-24-14	Feisty	1	low cost feline distemper		<del>21.00</del>	10.00
10-24-14		1	FelV/FIV ELISA in hosp	73.00	23.00	50.00 **
10-28-14	Strays	1	FECAL (ParasiteScreen) T808	29.50	14.75	14.75 **
10-29-14		1	No Ova Seen			0.00
10-29-14		2	EUTHANASIA - SOMLETHOL PEN			0.00
10-29-14		1	Shelter euthanasia and body care f			65.00
Total charges, this invoice...						139.75
**Total discount included: 37.75						

Your invoice total reflects our **13Stray Cat Accounts** discount.

Reminders for: <b>Strays</b>	Last done
10/15 Rabies/Purevax Feline 1yr	10-17-14
07/15 CONSULT/EXAM - Annual Wellness	
04/15 FECAL EXAM	10-28-14
<b>10/14 FVRCP Feline #2</b>	

LIKE US ON FACEBOOK.COM!

GOING AWAY?...BOOK YOUR PETS BOARDING RESERVATION TODAY!

In compliance with New York State law, all medications are non-refundable. We regret any inconveniences.

# INVOICE

## Newburgh Veterinary Hospital

1716 Route 300  
Newburgh, NY 12550  
845 564-2660

"Your pet is part of our family too." Visit us at [www.newburghvet.com](http://www.newburghvet.com)

**FOR:** Town of Newburgh - Feline  
645 Gidney Ave.  
Newburgh, NY 12550  
(845) 561-3344

**Printed:** 11-26-14 at 11:48a  
**Date:** 10-30-14  
**Account:** 4417  
**Invoice:** 586756

Date	For	Qty	Description	Price	Discount	Net Price
10-30-14	Kittens 10/20/1	0.09	Morphine Inject Control Log / ml			0.00
10-30-14		0.06	Telazol Injectable Control Log / ml			0.00
10-30-14		2	OHE FELINE	279.00	139.50	139.50 **
Your pet has been spayed. This eliminates the risk of uterine infection and lowers the risk of breast tumors when she gets older. Expect her to be quiet and not as active for a couple of days. Restrict exercise for the next two weeks. This receipt certifies that your pet has been spayed. Please keep this with your pet's health records.						
10-30-14		2	-Isoflurane Gas Anesthesia			0.00
10-30-14		1	NEUTER/FELINE	51.50	25.75	25.75 **
Total charges, this invoice...						165.25
**Total discount included: 165.25						

Your invoice total reflects our **13Stray Cat Accounts** discount.

LIKE US ON FACEBOOK.COM!

GOING AWAY?....BOOK YOUR PETS BOARDING RESERVATION TODAY!

In compliance with New York State law, all medications are non-refundable. We regret any inconveniences.

# INVOICE

**Newburgh Veterinary Hospital**

1716 Route 300  
 Newburgh, NY 12550  
 845 564-2660

"Your pet is part of our family too." Visit us at [www.newburghvet.com](http://www.newburghvet.com)

**FOR:** Town of Newburgh - Feline  
 645 Gidney Ave.  
 Newburgh, NY 12550  
 (845) 561-3344

**Printed:** 11-26-14 at 11:48a  
**Date:** 11-03-14  
**Account:** 4417  
**Invoice:** 586988

Date	For	Qty	Description	Price	Discount	Net Price
11-03-14	5th Ave Kittens	1	CONSULT / EXAM - Sick	59.50	29.75	29.75 **
11-03-14		1	Pet Insurance Review			0.00
Please visit <a href="http://www.petinsurancereview.com">www.petinsurancereview.com</a> and <a href="http://dogtime.com">dogtime.com</a> for an independent review of all national pet health insurance plans						
11-03-14		3	Feline Rhino/Panleuk/Calici #2	75.00	37.50	37.50 **
Your cat has received the second in a series of immunizations to protect her/him against Feline Distemper, Rhinotracheitis, and Calicivirus. It is important to return for a final booster in 3-4 weeks. Occasionally listlessness or localized discomfort might occur for the next few days. If you notice excessive listlessness or facial swelling, please call us for advice.						
11-03-14		3	Zoonoses			0.00
Discussed Zoonotic potential of intestinal parasites- in particular roundworms.						
11-03-14		3	NYS Mandated Biological Waste	18.00	9.00	9.00 **
11-01-14	Feisty	1	CONSULT / EXAM - Sick			59.50 ✓
11-01-14		1	Pet Insurance Review			0.00
Please visit <a href="http://www.petinsurancereview.com">www.petinsurancereview.com</a> and <a href="http://dogtime.com">dogtime.com</a> for an independent review of all national pet health insurance plans						
10-31-14	Munchkin	0.10	Telazol Injectable Control Log / ml			0.00
10-31-14		2	EUTHANASIA - SOMLETHOL PEN			0.00
10-31-14		1	Shelter euthanasia and body care f			65.00
10-31-14	Strays	1	Tobramycin Ophthalmic Suspensic	32.45	16.23	16.22 **

Total charges, this invoice... 216.97

\*\*Total discount included: 92.48

Your invoice total reflects our **13Stray Cat Accounts** discount.

# INVOICE

## Newburgh Veterinary Hospital

1716 Route 300  
Newburgh, NY 12550  
845 564-2660

"Your pet is part of our family too." Visit us at [www.newburghvet.com](http://www.newburghvet.com)

**FOR:** Town of Newburgh - Feline  
645 Gidney Ave.  
Newburgh, NY 12550  
(845) 561-3344

**Printed:** 11-26-14 at 11:47a  
**Date:** 11-20-14  
**Account:** 4417  
**Invoice:** 588132

Date	For	Qty	Description	Price	Discount	Net Price
11-04-14	5th Ave Kittens	2	NEUTER/FELINE	103.00	51.50	51.50 **
11-04-14		1	OHE FELINE	139.50	69.75	69.75 **
	Your pet has been spayed. This eliminates the risk of uterine infection and lowers the risk of breast tumors when she gets older. Expect her to be quiet and not as active for a couple of days. Restrict exercise for the next two weeks. This receipt certifies that your pet has been spayed. Please keep this with your pet's health records.					
11-04-14		1	-Isoflurane Gas Anesthesia			0.00
11-04-14		0.06	Morphine Inject Control Log / ml			0.00
11-04-14		0.06	Telazol Injectable Control Log / ml			0.00
11-04-14		3	Feline Rhino/Panleuk/Calici #2	75.00	37.50	37.50 **
	Your cat has received the second in a series of immunizations to protect her/him against Feline Distemper, Rhinotracheitis, and Calicivirus. It is important to return for a final booster in 3-4 weeks. Occasionally listlessness or localized discomfort might occur for the next few days. If you notice excessive listlessness or facial swelling, please call us for advice.					
11-04-14		3	RecommendFecal (please dropoff			0.00
	Annual fecal microscopic exams are very important for the health of your pet and, since some worms are transmissible to humans, for the health of your family. Please bring us your pet's fecal sample at your earliest convenience					
11-04-14		3	Zoonoses			0.00
	Discussed Zoonotic potential of intestinal parasites- in particular roundworms.					
11-19-14	Strays	2	Erythromycin Ophthalmic Ointment	75.00	37.50	37.50 **
Total charges, this invoice...						196.25
**Total discount included: 196.25						

Your invoice total reflects our **13Stray Cat Accounts** discount.

**NEUTER/FELINE**

Your cat has been neutered. Please watch the surgical site for swelling or redness.

**Butter's weight history (in lbs)**

---

11-22-14      4.10

---

LIKE US ON FACEBOOK.COM!

GOING AWAY?...BOOK YOUR PETS BOARDING RESERVATION TODAY!

In compliance with New York State law, all medications are non-refundable. We regret any inconveniences.





**TOWN OF NEWBURGH**

1496 Route 300  
Newburgh, New York 12550  
(845) 564-4552

DO NOT WRITE IN THIS BOX

Date Voucher Received		VOUCHER NO.
FUND - APPROPRIATION	AMOUNT	
Total		
Abstract #		

DEPARTMENT \_\_\_\_\_

CLAIMANT'S  
NAME  
AND  
ADDRESS

**NEWBURGH VETERINARY HOSPITAL**  
1716 Route 300  
Newburgh, NY 12550  
Tel: (845) 564-2660  
www.newburghvet.com

TERMS Net 30 Days

Invoice # \_\_\_\_\_

*Canine Page 1*

Dates	Quantity	Description of Materials or Services	Unit Price	Amount
7/29/14	584521			253.94
7/29/14	584529			51.88
01/7/14	585075			137.75
10/10/14	585283			176.00
10/14/14	585590			89.66
10/17/14	585780			84.75
10/21/14	586082			246.50
10/28/14	586574			32.75
10/30/14	586754			484.47
11/6/14	587180			317.47
<b>TOTAL</b>				232.91

**CLAIMANT'S CERTIFICATION**

*See next page for total*

I, \_\_\_\_\_, certify that the above account in the amount of \$ \_\_\_\_\_ is true and correct; that the items, services and disbursements charged were rendered to or for the municipality on the dates stated; that no part has been paid or satisfied; that taxes, from which the municipality is exempt, are not included; and that the amount claimed is actually due.

\_\_\_\_\_  
DATE SIGNATURE TITLE  
(Space below for municipal use)

**DEPARTMENT APPROVAL**

The above services or materials were rendered or furnished to the municipality on the dates stated and the charges are correct.

**APPROVAL FOR PAYMENT**

This claim is approved and ordered for paid from the appropriations indicated above

\_\_\_\_\_  
Date Authorized Official

\_\_\_\_\_  
Date Auditing Board

# INVOICE

## Newburgh Veterinary Hospital

1716 Route 300  
Newburgh, NY 12550  
845 564-2660

"Your pet is part of our family too." Visit us at [www.newburghvet.com](http://www.newburghvet.com)

**FOR:** Town of Newburgh - canine  
645 Gidney Ave  
Newburgh, NY 12550  
(845) 561-3344

**Printed:** 11-28-14 at 11:50a  
**Date:** 10-23-14  
**Account:** 19984  
**Invoice:** 586216

Date	For	Qty	Description	Price	Discount	Net Price
			Total charges, this invoice...			0.00
			Total payment(s) received...			14.03
			10-23-14 Cash payment		14.03	

LIKE US ON FACEBOOK.COM!

GOING AWAY?....BOOK YOUR PETS BOARDING RESERVATION TODAY!

In compliance with New York State law, all medications are non-refundable. We regret any inconveniences.

# INVOICE

## Newburgh Veterinary Hospital

1716 Route 300  
Newburgh, NY 12550  
845 564-2660

"Your pet is part of our family too." Visit us at [www.newburghvet.com](http://www.newburghvet.com)

**FOR:** Town of Newburgh - canine  
645 Gidney Ave  
Newburgh, NY 12550  
(845) 561-3344

**Printed:** 11-26-14 at 11:51a  
**Date:** 11-06-14  
**Account:** 19984  
**Invoice:** 587188

Date	For	Qty Description	Price	Discount	Net Price
11-06-14	Elsa	2 Amoxicillin 500 mg x 14 #189718	23.35	11.67	11.68 **
Total charges, this invoice...					11.68
**Total discount included: 11.67					

Your invoice total reflects our **13Stray Cat Accounts** discount.

Reminders for: <b>Elsa</b> (Weight: 48.6 lbs - 8m)	Last done
11/15 HEARTWORM TEST	11-05-14
11/15 CANINE RABIES / 3 YEAR	
11/15 CanineDist/Aden/Para/Parvo/Lep	
11/15 Canine Kennel Cough Vacc -1 ye	11-05-14
05/15 FECAL EXAM	
05/15 Consultation/Exam- Bi-annual	11-05-14

### Elsa's weight history (in lbs)

11-05-14 48.60

LIKE US ON FACEBOOK.COM!

GOING AWAY?...BOOK YOUR PETS BOARDING RESERVATION TODAY!

In compliance with New York State law, all medications are non-refundable. We regret any inconveniences.

# INVOICE

## Newburgh Veterinary Hospital

1716 Route 300  
Newburgh, NY 12550  
845 564-2660

"Your pet is part of our family too." Visit us at [www.newburghvet.com](http://www.newburghvet.com)

**FOR:** Town of Newburgh - canine  
645 Gidney Ave  
Newburgh, NY 12550  
(845) 561-3344

**Printed:** 11-26-14 at 11:51a  
**Date:** 11-08-14  
**Account:** 19984  
**Invoice:** 587352

Date	For	Qty	Description	Price	Discount	Net Price
11-07-14	Foster	1	CONSULT / EXAM - Sick	59.50	59.50	0.00 **
11-07-14		1	Pet Insurance Review			0.00
Please visit <a href="http://www.petinsurancereview.com">www.petinsurancereview.com</a> and <a href="http://dogtime.com">dogtime.com</a> for an independent review of all national pet health insurance plans						
11-07-14		1	CANINE RABIES / 1YEAR	25.00	12.50	12.50 **
				Total charges, this invoice...		12.50
				**Total discount included: 72.00		

Your invoice total reflects our **13Stray Cat Accounts** discount.

LIKE US ON FACEBOOK.COM!

GOING AWAY?....BOOK YOUR PETS BOARDING RESERVATION TODAY!

In compliance with New York State law, all medications are non-refundable. We regret any inconveniences.

# INVOICE

**Newburgh Veterinary Hospital**

1716 Route 300  
 Newburgh, NY 12550  
 845 564-2660

"Your pet is part of our family too." Visit us at [www.newburghvet.com](http://www.newburghvet.com)

<p><b>FOR:</b> Town of Newburgh - canine                  645 Gidney Ave                  Newburgh, NY 12550                  (845) 561-3344</p>	<p><b>Printed:</b> 11-26-14 at 11:51a  <b>Date:</b> 11-18-14  <b>Account:</b> 19984  <b>Invoice:</b> 588024</p>
--	---

Date	For	Qty Description	Price	Discount	Net Price	
11-06-14	Elsa	2 PCV ( Hct ) / Total Protein in hosp	40.00	20.00	20.00	**
11-06-14		1 PCV ( Hct ) / Total Protein in hosp	20.00	10.00	10.00	**
11-06-14		1 Rimadyl Inject / ml (in hosp)	40.00	32.50	7.50	**
11-06-14		1.50 Unasyn Inject / ml (in hosp)	31.56	27.03	4.53	**
11-06-14		1 Bandage & Dressings Change/Adji	31.50	15.75	15.75	**
11-06-14		1 Ultrasound Abdominal Cavity	299.50	149.75	149.75	**
11-06-14		1 PCV ( Hct ) / Total Protein in hosp	20.00	10.00	10.00	**
11-06-14		1 PCV ( Hct ) / Total Protein in hosp	20.00	10.00	10.00	**
11-07-14		1 PCV ( Hct ) / Total Protein in hosp	20.00	10.00	10.00	**
11-08-14		1 PCV ( Hct ) / Total Protein in hosp	20.00	10.00	10.00	**
11-10-14	Jesse-Jack Russ	1 CANINE RABIES / 1YEAR	25.00	12.50	12.50	**
11-10-14		1 Canine Dist/A2/PI/Parvo/Lepto1YR	26.00	13.00	13.00	**
Your pet has been vaccinated with Pfizer's new 5 in 1 DA2PPI , the best available protection against Distemper,Adenovirus, Parvovirus, Parainfluenza,and Leptosiprosis						
11-10-14		1 Canine Respiratory Complex- Borc	25.00	12.50	12.50	**
Canine Kennel Cough is A HIGHLY contagious respiratory infection. Dogs can be exposed at any time through coughing or nose to nose contact. Boarding, grooming and or showing dogs can have increasaded risk of exposure....please be sure to have your pet boosted every 12 months.						
11-10-14		1 Lyme,HW,Ehrlichia Accu Plus4(AC	49.50		49.50	
11-11-14		1 4DX Elisa Negative	0.00		0.00	

Total charges, this invoice... 335.03  
 \*\*Total discount included: 333.03

Your invoice total reflects our **13Stray Cat Accounts** discount.

Reminders for: Elsa (Weight: 48.6 lbs - 8m) Last done

# INVOICE

## Newburgh Veterinary Hospital

1716 Route 300  
Newburgh, NY 12550  
845 564-2660

"Your pet is part of our family too." Visit us at [www.newburghvet.com](http://www.newburghvet.com)

**FOR:** Town of Newburgh - canine  
645 Gidney Ave  
Newburgh, NY 12550  
(845) 561-3344

**Printed:** 11-26-14 at 11:51a  
**Date:** 11-06-14  
**Account:** 19984  
**Invoice:** 587180

Date	For	Qty	Description	Price	Discount	Net Price
11-05-14	Dixie	1	CONSULT / EXAM - Annual Welln	49.50	24.75	24.75 **
11-05-14		1	Canine Dist/A2/PI/Parvo/Lepto1YR	26.00	13.00	13.00 **
Your pet has been vaccinated with Pfizer's new 5 in 1 DA2PPI , the best available protection against Distemper,Adenovirus, Parvovirus, Parainfluenza,and Leptosiprosis						
11-05-14		1	CANINE RABIES / 1YEAR	25.00	12.50	12.50 **
11-05-14		1	Canine Respiratory Complex- Boro	25.00	12.50	12.50 **
Canine Kennel Cough is A HIGHLY contagious respiratory infection. Dogs can be exposed at any time through coughing or nose to nose contact. Boarding, grooming and or showing dogs can have incresased risk of exposure....please be sure to have your pet boosted every 12 months.						
11-05-14		1	Lyme,HW,Ehrlichia Accu Plus4(AC	49.50	21.00	28.50 ** ✓
11-06-14		1	4DX Elisa Negative			0.00
11-05-14	Elsa	1	CANINE RABIES / 1YEAR	25.00	12.50	12.50 **
11-05-14		1	Canine Dist/A2/PI/Parvo/Lepto1YR	26.00	13.00	13.00 **
Your pet has been vaccinated with Pfizer's new 5 in 1 DA2PPI , the best available protection against Distemper,Adenovirus, Parvovirus, Parainfluenza,and Leptosiprosis						
11-05-14		1	Canine Respiratory Complex- Boro	25.00	12.50	12.50 **
Canine Kennel Cough is A HIGHLY contagious respiratory infection. Dogs can be exposed at any time through coughing or nose to nose contact. Boarding, grooming and or showing dogs can have incresased risk of exposure....please be sure to have your pet boosted every 12 months.						
11-05-14		1	Lyme,HW,Ehrlichia Accu Plus4(AC	49.50	21.00	28.50 **
11-05-14		1	CONSULT / EXAM - Annual Welln	49.50	24.75	24.75 **
11-05-14		1	OHE Canine In Heat	249.50	124.75	124.75 **
11-05-14		1.08	Morphine Inject Control Log / ml			0.00
11-05-14		0.48	Telazol Injectable Control Log / ml			0.00
11-05-14		1	Amoxicillin 500 mg x 14 #189708	20.45	10.23	10.22 **
11-06-14		1	Heartworm Elisa Negative			0.00
11-06-14		1	Ehrlichia Canis Elisa negative			0.00
11-06-14		1	Ehrlichia (Anaplasma) Equi Negativ			0.00

---

Total charges, this invoice... 317.47  
\*\*Total discount included: 302.48

Your invoice total reflects our **13Stray Cat Accounts** discount.

Reminders for: <b>Elsa</b> (Weight: 48.6 lbs - 8m)		Last done
11/15	HEARTWORM TEST	11-05-14
11/15	CANINE RABIES / 3 YEAR	
11/15	CanineDist/Aden/Para/Parvo/Lep	
11/15	Canine Kennel Cough Vacc -1 ye	11-05-14
05/15	FECAL EXAM	
05/15	Consultation/Exam- Bi-annual	11-05-14

**Elsa's weight history** (in lbs)

---

11-05-14	48.60
----------	-------

---

LIKE US ON FACEBOOK.COM!

GOING AWAY?...BOOK YOUR PETS BOARDING RESERVATION TODAY!

In compliance with New York State law, all medications are non-refundable. We regret any inconveniences.



# INVOICE

## Newburgh Veterinary Hospital

1716 Route 300  
Newburgh, NY 12550  
845 564-2660

"Your pet is part of our family too." Visit us at [www.newburghvet.com](http://www.newburghvet.com)

**FOR:** Town of Newburgh - canine  
645 Gidney Ave  
Newburgh, NY 12550  
(845) 561-3344

**Printed:** 11-26-14 at 11:52a  
**Date:** 10-30-14  
**Account:** 19984  
**Invoice:** 586754

Date	For	Qty	Description	Price	Discount	Net Price
10-23-14	Angel	1	CONSULT / EXAM - Urgent	85.00	85.00	0.00 **
10-23-14	A <i>Spen</i> child	1	NYS Mandated Biological Waste	6.00	3.00	3.00 **
10-23-14		1	ANESTHESIA -Isoflurane	179.50	89.75	89.75 **
10-23-14		1	Laceration- Grade 2 (5-10 cm)			94.75
10-23-14		0.40	Buprenex Inject Control Log / ml			0.00
10-23-14		2.50	Penicillin G Inject / ml (in hosp)	31.25	15.63	15.62 **
10-23-14		0.50	Telazol Injectable Control Log / ml			0.00
10-23-14		14	Rilexine 600mg chewable tablets #	27.49	13.75	13.74 **
10-23-14		4	Vetprofen Tablets 75mg #189168	20.27	10.13	10.14 **
10-23-14		1	Shelter board run			21.50
10-29-14	Jesse-Jack Russ	1	CONSULT / EXAM - Sick	59.50	29.75	29.75 ** ✓
10-29-14		1	Pet Insurance Review			0.00
Please visit <a href="http://www.petinsurancereview.com">www.petinsurancereview.com</a> and <a href="http://dogtime.com">dogtime.com</a> for an independent review of all national pet health insurance plans						
10-29-14		1	NYS Mandated Biological Waste	6.00	3.00	3.00 **
10-29-14		1	Drontal Plus Intestinal Wormer <2	29.00	14.50	14.50 ** ✓
10-29-14		1	FECAL (ParasiteScreen) T808	29.50	14.75	14.75 ** ✓
10-30-14		1	No Ova Seen			0.00
10-29-14	Naolani	1	CANINE RABIES / 1YEAR	25.00	12.50	12.50 ** ✓
10-23-14	Rosie 113-14	1	OHE CANINE <7 MOS.	169.50	84.75	84.75 ** ✓
Your pet has been spayed. This eliminates the risk of uterine infection and lowers the risk of breast tumors when she gets older. Expect her to be quiet and not as active for a few days. Restrict exercise for two weeks. This receipt certifies that your pet has been spayed. Please keep this with your pet's health records.						
10-23-14		1	-Isoflurane Gas Anesthesia			0.00
10-23-14		0.26	Morphine Inject Control Log / ml			0.00
10-23-14		0.13	Telazol Injectable Control Log / ml			0.00
10-23-14		1	CANINE RABIES / 1YEAR	25.00	12.50	12.50 ** ✓
10-23-14		1	Canine Respiratory Complex- Boro	25.00	12.50	12.50 ** ✓

Canine Kennel Cough is A HIGHLY contagious respiratory infection. Dogs can be exposed at any time through coughing or nose to nose contact. Boarding, grooming and or showing dogs can have increased risk of exposure....please be

protection against Distemper, Adenovirus, Parvovirus, Parainfluenza, and Leptosiprosis

10-20-14	1 Canine Respiratory Complex- Borc	25.00	12.50	12.50 **
	Canine Kennel Cough is A HIGHLY contagious respiratory infection. Dogs can be exposed at any time through coughing or nose to nose contact. Boarding, grooming and or showing dogs can have increased risk of exposure....please be sure to have your pet boosted every 12 months.			
10-20-14	1 Lyme, HW, Ehrlichia Accu Plus4(AC	49.50	21.00	28.50 **
10-21-14	1 Heartworm Elisa Negative			0.00
10-21-14	1 Ehrlichia Canis Elisa negative			0.00
10-21-14	1 Anaplasma Equi Elisa Negative			0.00
Total charges, this invoice...				246.50
**Total discount included: 239.00				

Your invoice total reflects our **13Stray Cat Accounts** discount.

LIKE US ON FACEBOOK.COM!

GOING AWAY?...BOOK YOUR PETS BOARDING RESERVATION TODAY!

In compliance with New York State law, all medications are non-refundable. We regret any inconveniences.

sure to have your pet boosted every 12 months.

10-23-14	1 Canine Dist/A2/PI/Parvo/Lepto1YR	26.00	13.50	12.50 **	✓
	Your pet has been vaccinated with Pfizer's new 5 in 1 DA2PPI , the best available protection against Distemper,Adenovirus, Parvovirus, Parainfluenza,and Leptosiprosis				
10-23-14	1 Lyme,HW,Ehrlichia Accu Plus4(AC	49.50	21.00	28.50 **	✓
10-24-14	1 Heartworm Elisa Negative			0.00	
10-24-14	1 Ehrlichia Canis Elisa negative			0.00	
10-24-14	1 Anaplasma Equi Elisa Negative			0.00	
10-28-14	3 Amoxicillin 100mg x 14 #189364	21.45	10.73	10.72 **	✓
Total charges, this invoice...				484.47	
**Total discount included: 446.74					

Your invoice total reflects our **13Stray Cat Accounts** discount.

---

LIKE US ON FACEBOOK.COM!

GOING AWAY?...BOOK YOUR PETS BOARDING RESERVATION TODAY!

In compliance with New York State law, all medications are non-refundable. We regret any inconveniences.

# INVOICE

## Newburgh Veterinary Hospital

1716 Route 300  
Newburgh, NY 12550  
845 564-2660

"Your pet is part of our family too." Visit us at [www.newburghvet.com](http://www.newburghvet.com)

**FOR:** Town of Newburgh - canine  
645 Gidney Ave  
Newburgh, NY 12550  
(845) 561-3344

**Printed:** 11-26-14 at 11:52a  
**Date:** 10-28-14  
**Account:** 19984  
**Invoice:** 586574

Date	For	Qty	Description	Price	Discount	Net Price
10-28-14	Lotto 90-14	1	CONSULT / EXAM - Sick	59.50	29.75	29.75 ** ✓
10-28-14		1	Pet Insurance Review			0.00
			Please visit <a href="http://www.petinsurancereview.com">www.petinsurancereview.com</a> and <a href="http://dogtime.com">dogtime.com</a> for an independent review of all national pet health insurance plans			
10-28-14		1	NYS Mandated Biological Waste	6.00	3.00	3.00 **
10-28-14		1	Medicating instructions			0.00
			temaril p - 2tabs PO BID x 4 days, then 2tabs PO SID x 4days, then EOD x 4 days. #32 mupirocin - apply to digits (underneath) BID x 10days If mupirocin does not work may need to do neo-predef			

Total charges, this invoice... 32.75  
\*\*Total discount included: 32.75

Your invoice total reflects our **13Stray Cat Accounts** discount.

LIKE US ON FACEBOOK.COM!

GOING AWAY?....BOOK YOUR PETS BOARDING RESERVATION TODAY!

In compliance with New York State law, all medications are non-refundable. We regret any inconveniences.

# INVOICE

## Newburgh Veterinary Hospital

1716 Route 300  
Newburgh, NY 12550  
845 564-2660

"Your pet is part of our family too." Visit us at [www.newburghvet.com](http://www.newburghvet.com)

**FOR:** Town of Newburgh - canine  
645 Gidney Ave  
Newburgh, NY 12550  
(845) 561-3344

**Printed:** 11-28-14 at 11:50a  
**Date:** 10-21-14  
**Account:** 19984  
**Invoice:** 586082

Date	For	Qty	Description	Price	Discount	Net Price
10-20-14	London 112-14	0.60	Morphine Inject Control Log / ml			0.00
10-20-14		0.40	Telazol Injectable Control Log / ml			0.00
10-20-14		1	OHE CANINE <7 MOS.	169.50	84.75	84.75 ** ✓
	Your pet has been spayed. This eliminates the risk of uterine infection and lowers the risk of breast tumors when she gets older. Expect her to be quiet and not as active for a few days. Restrict exercise for two weeks. This receipt certifies that your pet has been spayed. Please keep this with your pet's health records.					
10-20-14		1	-Isoflurane Gas Anesthesia			0.00
10-20-14		1	Canine Dist/Aden/Para/Parvo #1	26.00	13.00	13.00 ** ✓
	Your pet has been given the first in a series that requires revaccination every 3-4 weeks until your puppy is approximately 14-16 weeks of age. Occasionally, loss of appetite, listlessness, or localized discomfort may occur. If there is severe lethargy or facial swelling, call us for advice.					
10-20-14		1	RecommendFecal (please dropoff			0.00
	Annual fecal microscopic exams are very important for the health of your pet and, since some worms are transmissible to humans, for the health of your family. Please bring us your pet's fecal sample at your earliest convenience					
10-20-14		1	Zoonoses			0.00
	Discussed Zoonotic potential of intestinal parasites- in particular roundworms.					
10-20-14		1	Canine Respiratory Complex- Borc	25.00	12.50	12.50 ** ✓
	Canine Kennel Cough is A HIGHLY contagious respiratory infection. Dogs can be exposed at any time through coughing or nose to nose contact. Boarding, grooming and or showing dogs can have increased risk of exposure....please be sure to have your pet boosted every 12 months.					
10-20-14		1	CANINE RABIES / 1YEAR	25.00	12.50	12.50 ** ✓
10-20-14	Sebastian	0.80	Morphine Inject Control Log / ml			0.00
10-20-14		0.45	Telazol Injectable Control Log / ml			0.00
10-20-14		1	NEUTER/CANINE <1YR	139.50	69.75	69.75 ** ✓
10-20-14		1	-Isoflurane Gas Anesthesia			0.00
10-20-14		1	Canine Dist/A2/PI/Parvo/Lepto1YR	26.00	13.00	13.00 ** ✓
	Your pet has been vaccinated with Pfizer's new 5 in 1 DA2PPI , the best available					

# INVOICE

## Newburgh Veterinary Hospital

1716 Route 300  
Newburgh, NY 12550  
845 564-2660

"Your pet is part of our family too." Visit us at [www.newburghvet.com](http://www.newburghvet.com)

**FOR:** Town of Newburgh - canine  
645 Gidney Ave  
Newburgh, NY 12550  
(845) 561-3344

**Printed:** 11-28-14 at 11:51a  
**Date:** 10-17-14  
**Account:** 19984  
**Invoice:** 585780

Date	For	Qty	Description	Price	Discount	Net Price
10-15-14	Angel	0.70	Morphine Inject Control Log / ml			0.00
10-15-14		0.50	Telazol Injectable Control Log / ml			0.00
10-15-14		1	OHE CANINE <7 MOS.	169.50	84.75	84.75 **✓
	Your pet has been spayed. This eliminates the risk of uterine infection and lowers the risk of breast tumors when she gets older. Expect her to be quiet and not as active for a few days. Restrict exercise for two weeks. This receipt certifies that your pet has been spayed. Please keep this with your pet's health records.					
10-15-14		1	-Isoflurane Gas Anesthesia			0.00
Total charges, this invoice...						84.75
**Total discount included: 84.75						

Your invoice total reflects our **13Stray Cat Accounts** discount.

LIKE US ON FACEBOOK.COM!

GOING AWAY?....BOOK YOUR PETS BOARDING RESERVATION TODAY!

In compliance with New York State law, all medications are non-refundable. We regret any inconveniences.

# INVOICE

## Newburgh Veterinary Hospital

1716 Route 300  
Newburgh, NY 12550  
845 564-2660

"Your pet is part of our family too." Visit us at [www.newburghvet.com](http://www.newburghvet.com)

**FOR:** Town of Newburgh - canine  
645 Gidney Ave  
Newburgh, NY 12550  
(845) 561-3344

**Printed:** 11-28-14 at 11:52a  
**Date:** 10-14-14  
**Account:** 19984  
**Invoice:** 585590

Date	For	Qty	Description	Price	Discount	Net Price
10-14-14	London 112-14	1	CONSULT / EXAM - Sick	59.50	29.75	29.75 ** ✓
10-14-14		1	Pet Insurance Review			0.00
Please visit <a href="http://www.petinsurancereview.com">www.petinsurancereview.com</a> and <a href="http://dogtime.com">dogtime.com</a> for an independent review of all national pet health insurance plans						
10-14-14		1	NYS Mandated Biological Waste	6.00	3.00	3.00 **
10-14-14		20	Rilexine 300mg chewable tablets #	25.35	12.67	12.68 **
10-14-14	Rosie 113-14	1	CONSULT / EXAM - Sick	59.50	29.75	29.75 ** ✓
10-14-14		1	Pet Insurance Review			0.00
Please visit <a href="http://www.petinsurancereview.com">www.petinsurancereview.com</a> and <a href="http://dogtime.com">dogtime.com</a> for an independent review of all national pet health insurance plans						
10-14-14		1	NYS Mandated Biological Waste	6.00	3.00	3.00 **
10-14-14		20	Rilexine 150mg chewable tablets #	22.95	11.47	11.48 **
Total charges, this invoice...						89.66

\*\*Total discount included: 89.64

Your invoice total reflects our **13Stray Cat Accounts** discount.

LIKE US ON FACEBOOK.COM!

GOING AWAY?...BOOK YOUR PETS BOARDING RESERVATION TODAY!

In compliance with New York State law, all medications are non-refundable. We regret any inconveniences.

# INVOICE

## Newburgh Veterinary Hospital

1716 Route 300  
Newburgh, NY 12550  
845 564-2660

"Your pet is part of our family too." Visit us at [www.newburghvet.com](http://www.newburghvet.com)

**FOR:** Town of Newburgh - canine  
645 Gidney Ave  
Newburgh, NY 12550  
(845) 561-3344

**Printed:** 11-28-14 at 11:52a  
**Date:** 10-10-14  
**Account:** 19984  
**Invoice:** 585283

Date	For	Qty	Description	Price	Discount	Net Price
10-08-14	Angel	1	CONSULT / EXAM - Annual Welln	49.50	24.75	24.75 ** ✓
10-08-14		1	Lyme,HW,Ehrlichia Accu Plus4(AC	49.50	21.00	28.50 ** ✓
10-08-14		1	CANINE RABIES / 1YEAR	25.00	12.50	12.50 ** ✓
10-08-14		1	Canine Dist/A2/PI/Parvo/Lepto1YR	26.00	13.00	13.00 ** ✓
Your pet has been vaccinated with Pfizer's new 5 in 1 DA2PPI , the best available protection against Distemper,Adenovirus, Parvovirus, Parainfluenza,and Leptosiprosis						
10-08-14		1	Canine Respiratory Complex- Borc	25.00	12.50	12.50 **
Canine Kennel Cough is A HIGHLY contagious respiratory infection. Dogs can be exposed at any time through coughing or nose to nose contact. Boarding, grooming and or showing dogs can have increasased risk of exposure....please be sure to have your pet boosted every 12 months.						
10-10-14		1	Heartworm Elisa Negative			0.00
10-10-14		1	Ehrlichia Canis Elisa negative			0.00
10-08-14	Princess Penelo	0.17	Morphine Inject Control Log / ml			0.00
10-08-14		0.10	Telazol Injectable Control Log / ml			0.00
10-08-14		1	OHE CANINE <7 MOS.	169.50	84.75	84.75 ** ✓
Your pet has been spayed. This eliminates the risk of uterine infection and lowers the risk of breast tumors when she gets older. Expect her to be quiet and not as active for a few days. Restrict excercise for two weeks. This receipt certifies that your pet has been spayed. Please keep this with your pet's health records.						
10-08-14		1	-Isoflurane Gas Anesthesia			0.00

Total charges, this invoice... 176.00  
\*\*Total discount included: 168.50

Your invoice total reflects our **13Stray Cat Accounts** discount.

LIKE US ON FACEBOOK.COM!



# INVOICE

## Newburgh Veterinary Hospital

1716 Route 300  
Newburgh, NY 12550  
845 564-2660

"Your pet is part of our family too." Visit us at [www.newburghvet.com](http://www.newburghvet.com)

**FOR:** Town of Newburgh - canine  
645 Gidney Ave  
Newburgh, NY 12550  
(845) 561-3344

**Printed:** 11-28-14 at 11:52a  
**Date:** 10-07-14  
**Account:** 19984  
**Invoice:** 585075

Date	For	Qty	Description	Price	Discount	Net Price
10-07-14	Princess Penelo	1	CONSULT / EXAM - Annual Welln	49.50	24.75	24.75 ** ✓
10-07-14		1	Canine Dist/Aden/Para/Parvo #1	26.00	13.00	13.00 ** ✓
	Your pet has been given the first in a series that requires revaccination every 3-4 weeks until your puppy is approximately 14-16 weeks of age. Occasionally, loss of appetite, listlessness, or localized discomfort may occur. If there is severe lethargy or facial swelling, call us for advice.					
10-07-14		1	RecommendFecal (please dropoff			0.00
	Annual fecal microscopic exams are very important for the health of your pet and, since some worms are transmissible to humans, for the health of your family. Please bring us your pet's fecal sample at your earliest convenience					
10-07-14		1	Zoonoses			0.00
	Discussed Zoonotic potential of intestinal parasites- in particular roundworms.					
10-07-14	William	1	Shelter euth and body care k9 31-6			100.00 ✓
10-07-14		7	EUTHANASIA - SOMLETHOL PEN			0.00
Total charges, this invoice...						137.75
**Total discount included: 37.75						

Your invoice total reflects our **13Stray Cat Accounts** discount.

LIKE US ON FACEBOOK.COM!

GOING AWAY?...BOOK YOUR PETS BOARDING RESERVATION TODAY!

In compliance with New York State law, all medications are non-refundable. We regret any inconveniences.

# INVOICE

## Newburgh Veterinary Hospital

1716 Route 300  
Newburgh, NY 12550  
845 564-2660

"Your pet is part of our family too." Visit us at [www.newburghvet.com](http://www.newburghvet.com)

**FOR:** Town of Newburgh - canine  
645 Gidney Ave  
Newburgh, NY 12550  
(845) 561-3344

**Printed:** 11-28-14 at 11:53a  
**Date:** 09-29-14  
**Account:** 19984  
**Invoice:** 584529

Date	For	Qty	Description	Price	Discount	Net Price
09-28-14	107-14	1	CONSULT / EXAM - Sick	59.50	29.75	29.75 ** ✓
09-28-14		1	Pet Insurance Review			0.00
Please visit <a href="http://www.petinsurancereview.com">www.petinsurancereview.com</a> and <a href="http://dogtime.com">dogtime.com</a> for an independent review of all national pet health insurance plans						
09-28-14		1	NYS Mandated Biological Waste	6.00	3.00	3.00 **
09-28-14		6	K9/Fel A/D 5.5oz Can	13.26	6.63	6.63 ** ✓
09-29-14		1	CANINE RABIES / 1YEAR	25.00	12.50	12.50 **
Total charges, this invoice...						51.88
**Total discount included: 51.88						

Your invoice total reflects our **13Stray Cat Accounts** discount.

LIKE US ON FACEBOOK.COM!

GOING AWAY?....BOOK YOUR PETS BOARDING RESERVATION TODAY!

In compliance with New York State law, all medications are non-refundable. We regret any inconveniences.

# INVOICE

## Newburgh Veterinary Hospital

1716 Route 300  
Newburgh, NY 12550  
845 564-2660

"Your pet is part of our family too." Visit us at [www.newburghvet.com](http://www.newburghvet.com)

**FOR:** Town of Newburgh - canine  
645 Gidney Ave  
Newburgh, NY 12550  
(845) 561-3344

**Printed:** 11-28-14 at 11:53a  
**Date:** 09-29-14  
**Account:** 19984  
**Invoice:** 584521

Date	For	Qty	Description	Price	Discount	Net Price	
09-25-14	Lotto 90-14	20	Rilexine 600mg chewable tablets #	31.75	15.87	15.88	** ✓
09-25-14		1	Mupirocin Antibacterial Ointment #	27.00	13.50	13.50	** ✓
09-25-14		1	Prednisolone 5mg tablets x 20 #18	28.75	14.37	14.38	** ✓
09-25-14		1	Skin Scraping (xMites)REPEAT	17.10	8.55	8.55	** ✓
09-25-14		1	CONSULT / EXAM - Followup	39.75	19.87	19.88	** ✓
09-25-14		1	Pet Insurance Review			0.00	
Please visit <a href="http://www.petinsurancereview.com">www.petinsurancereview.com</a> and <a href="http://dogtime.com">dogtime.com</a> for an independent review of all national pet health insurance plans							
09-25-14	Shorty	0.80	Morphine Inject Control Log / ml			0.00	
09-25-14		0.50	Telazol Injectable Control Log / ml			0.00	
09-25-14		1	CANINE RABIES / 1YEAR	25.00	12.50	12.50	** ✓
09-25-14		1	Canine Respiratory Complex- Borc	25.00	12.50	12.50	** ✓
Canine Kennel Cough is A HIGHLY contagious respiratory infection. Dogs can be exposed at any time through coughing or nose to nose contact. Boarding, grooming and or showing dogs can have increased risk of exposure....please be sure to have your pet boosted every 12 months.							
09-25-14		1	Canine Dist/A2/PI/Parvo/Lepto1YR	26.00	13.00	13.00	** ✓
Your pet has been vaccinated with Pfizer's new 5 in 1 DA2PPI , the best available protection against Distemper,Adenovirus, Parvovirus, Parainfluenza,and Leptosiprosis							
09-25-14		1	NEUTER/CANINE <1YR	139.50	69.75	69.75	** ✓
09-25-14		1	-Isoflurane Gas Anesthesia			0.00	
09-25-14		1	Lyme,HW,Ehrlichia Accu Plus4(AC			<del>249.50</del>	✓
09-26-14		1	Drontal Plus Intestinal Wormer 41-	49.00	24.50	24.50	**
09-26-14		1	4DX Elisa Negative			0.00	

Total charges, this invoice... 253.94

\*\*Total discount included: 204.41

Your invoice total reflects our **13Stray Cat Accounts** discount.

Lease of GPS Vehicle Tracking System

Company	Warrantee	Tracking	Monthly Charge Based on 60 Month lease
GPS Tracking Solutions Montgomery New York	36 months	2 min updates	\$ 32.45 X 39 = \$ 1,265.55 month
Vehicle Tracking Solutions Commack New York	60 months	1 min updates	\$ 29.99 X 39 = \$ 1,169.61 month
GPS Insight Henkel Way Scottsdale Arizona	60 months	2 min updates	\$ 27.95 X 39 = \$ 1,090.05 month

The above is based on 39 Units the cost will be charged to the proper department between Highway, Sewer, Water Distribution Code, Assessor, and animal control from the 2015 Budget

I am recommending Vehicle Tracking Solutions due to the fact their technology can supply one minute updates and the outstanding recommendation from Richard Fon Deputy DPW Commissioner of Town of Greenburgh.

September 30, 2014

**Town of Newburgh**

1496 Route 300  
Newburgh, New York 12550

Attention: Gil Piaquadio, Deputy Supervisor Acting As Supervisor

Dear Supervisor Piaquadio,

We are please to present our proposal with two options.

- Outright Purchase
- Bundled Lease

This is a short summary of the all-inclusive features that are part of the system.

- Powerful Reporting System
- 24/7 Web Based Software
- Starter disable/enable
- Remote Door Unlock (power automatic car doors)
- Unlimited Users
- Separation of Fleets by Department or Location
- Alerts through Cell phone and/or email (no movement, speed, idling and geofence)
- Improve safety through monitoring of speed and vehicle usage
- Mobile Phone, Laptop or Tablet access to website
- Importing of Landmarks

Sincerely,

Tracking Systems, Inc

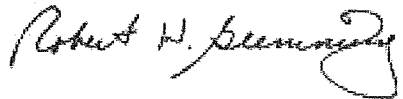

Robert H Glemming

Vice President, Sales and Marketing

GPS TRACKING SOLUTIONS

# BUNDLED LEASE

\$1.00 Buyout

Term	Units	Monthly Fee	Extension
24	39	\$41.00	\$1,599.00
36	39	\$36.00	\$1,404.00
48	39	\$33.91	\$1,322.49
60	39	\$32.45	\$1,265.55

All Inclusive Hardware, Monthly Web Service, Activation Programming Fee and Installation

First month payment due in advance.

PROPOSAL  
FOR  
TOWN OF NEWBURGH

Submitted by: Anthony Pavone



[vehicletrackingsolutions.com](http://vehicletrackingsolutions.com)

152 Veterans Mem Hwy  
Commack NY 11725  
[www.VehicleTrackingSolutions.com](http://www.VehicleTrackingSolutions.com)

December 17, 2014

## Pricing for 39 GPS Units

### Silent Passenger Subscription

\$29.99 per vehicle per month for 60 Months

**Silent Passenger Subscription:** Includes VTS owned hardware, installation, all service calls, free removal/reinstalls, full hardware + labor warranty. Equipment must be returned at end of term or customer must sign a renewal agreement.

### Description

- GPS Receiver/Wireless Data Modem
- *Enfora CDMA with Verizon Technology AVL*
- *Programmed with VTS proprietary script for event-based engine*
  - *Over the air programming capabilities*

Silent Passenger Access  
*1 minute updates plus 5 second "rapid updates"*





Gil Piaquadio <councilmanpiaquadio@townofnewburgh.org>

**Pricing and Product Information**

1 message

**Phil Eatman** <phil.eatman@gpsinsight.com>

Mon, Dec 22, 2014 at 4:28 PM

To: Gil Piaquadio <councilmanpiaquadio@townofnewburgh.org>

Hi Gil:

Thank you for your time today and look forward to your decision. I know that you have seen other providers but definitely think that GPs Insight offers one of the most robust platforms in our industry. Below is a link that will give you a quick overview of the GPS Insight capabilities and functionality. Also below is the pricing for a 60 month contract per your request. I know this is a big decision so please feel free to contact me with any questions. Thanks and have a safe and happy holidays!

GPS Insight Overview:

<http://clearslide.com/view/mail?iID=MQTFQ7FNY9W4BHQCRXJ>

**Pricing Per Vehicle:**

**3900E** -

Subscription (Minimum of 5 units required)

- Equipment -
- Monthly -
- Installation -
- Training -
- Support -
- Contract -

Included - Lifetime Warranty  
 \$27.95 (2 minute updates)  
 GPS Insight Install Included  
 Included and Unlimited  
 Included and Unlimited (24/7/365)  
 60 Month Contract Required



**TOWN OF NEWBURGH**

1496 Route 300, Newburgh, New York 12550

*Brenda*

PERSONNEL DEPT.

PH: 845-566-7785

Fax: 845-564-2170

To: Gilbert Piaquadio, Deputy Supervisor  
Town Board  
Ron Clum, Town Accountant

From: Charlene M Black, Personnel

Date: December 23, 2014

Re: Seasonal Workers

---

The following people have been interviewed for Seasonal Full time(100 days):

Joseph Baker  
Matthew Jones  
Jason Lenko  
Sal Marcantonio  
Gerald Schafer  
Danny Torres  
Michael Wiggins

If approved all need to complete their paperwork, be fingerprinted and Drug and Alcohol tested. If you would like to see their full application, please come to my office and I will have them readily available. A start date on or after January 8, 2015.



# HIGHWAY DEPARTMENT

90 GARDNERTOWN ROAD  
NEWBURGH, NEW YORK 12550

TELEPHONE 845-561-2177  
FAX 845-561-8987

TODD DEPEW  
HIGHWAY SUPERINTENDENT

**TO:** Charlene Black, Personnel Department  
**FROM:** Todd DePew, Highway Superintendent  
**DATE:** December 23, 2014  
**RE:** Seasonal Employees

I am recommending the following candidates for full time seasonal work at the Town of Newburgh Highway Department. Their titles will be seasonal laborer and the rate of pay will be \$12.00 per hour, with a tentative start date of on or after January 8, 2015. Thank you.

Joseph Baker  
Matthew Jones  
Jason Lenko  
Sal Marcantonio  
Gerald Shafer  
Danny Torres  
Michael Wiggins

TD:ch



## Orange County Board of Elections

25 Court Lane, PO Box 30

Goshen, NY 10924

Office (845) 291-2444

Fax (845) 291-2437

Toll Free 888-879-7655

[www.orangecountygov.com/elections](http://www.orangecountygov.com/elections)

[elections@orangecountygov.com](mailto:elections@orangecountygov.com)

22n  
+  
22B

Susan Bahren  
*Commissioner*

David C. Green  
*Commissioner*

December 23, 2014

Gilbert Piaquadio, Supervisor  
Town of Newburgh  
1496 Route 300  
Newburgh, NY 12550

Dear Supervisor Piaquadio,

On December 18, 2014 the Orange County Legislature approved a resolution to apportion and levy expenses against the cities and towns in the County of Orange to pay a portion of three elections, the June 24<sup>th</sup> Federal Primary Election, the September 9<sup>th</sup> State & Local Primary Election and November 4<sup>th</sup> General Election expenses incurred by the County in 2014.

Section 3-226 of the New York State Election Law provides that all or any part of the type of expenses connected with elections and matters preliminary or relating thereto that were previously incurred by towns and cities, may be apportioned to a city or town.

Section 361-a of County Law provides for the levy of unpaid expenses upon the tax rolls of the said towns and cities in the next succeeding year.

The charge to the Town of Newburgh for cost associated with the three elections in 2014 is \$65,581.79. All checks are to be made payable to the Commissioner of Finance and mailed to the Orange County Board of Elections at 25 Court Lane, PO BOX 30, Goshen, NY 10924 by March 1, 2015. Uncollected charges shall be levied on the 2016 tax rolls of said towns and cities.

An itemization of the 2014 election expenses for the Town of Newburgh is provided as follows,

Election Inspectors (incl. training)		
Federal Primary	\$ 7,343.48	
State & Local Primary	17,879.72	
General Election	27,329.07	
Total Inspector Expenses		\$52,552.27
Poll Site Rental Expenses		\$ 1,450.00
Machine Delivery		
Federal Primary	\$ 1,290.00	
State & Local Primary	2,520.00	
General Election	2,720.00	
Total Delivery Expenses		\$ 6,530.00
Pre-Election Machine Logic & Accuracy Testing		
State & Local Primary	\$ 563.40	
General Election	551.85	
Total Pre-Lat Testing		\$ 1,115.25
Field Technician Expenses		
Federal Primary	\$ 340.00	
State & Local Primary	340.00	
General Election	340.00	
Total Field Technician Expense		\$ 1,020.00
Post-Election Allocated Audit Expense		
Federal Primary	\$ 12.00	
State & Local Primary	38.28	
General Election	431.60	
Total Post-Election Audit Expense		\$ 481.88
Polling Place Set-Up/Take Down		
Federal Primary	\$ 240.00	
State & Local Primary	960.00	
General Election	960.00	
Total Polling Place Set-Up/Take Down		\$ 2,160.00

Warehouse Allocated Expense

Incl. packing cost for election bags and carts \$ 272.39

TOTAL EXPENSE

\$65,581.79

Should you have any questions regarding this matter please feel free to contact us.

Sincerely,



Susan Bahren  
Commissioner of Elections



David C. Green  
Commissioner of Elections

Cc: Andrew Zarutskie, Town Clerk

12-29-2014

To: Town Board Members

I am requesting \$ 13,582.00 from 001-1990-0499 to 001-1450-0497 this transfer is necessary to pay Orange County for the 2014 Elections.

A handwritten signature in black ink, consisting of a large, stylized 'G' followed by a cursive name, all enclosed within a circular flourish.