

Wednesday, November 12, 2014
7:00 p.m.

1. ROLL CALL
2. PLEDGE OF ALLEGIANCE TO THE FLAG
3. MOMENT OF SILENCE
4. CHANGES TO AGENDA
5. APPROVAL OF AUDIT
6. RECEIVER OF TAXES: Approval of 2014 Water & Sewer Relevy
7. JUSTICE COURT:
 - A. Replacement of Postage Machine
 - B. Court Officer Residency Local Law
8. UNSAFE BUILDING:
 - A. 19 Wintergreen Avenue
 - B. 5228 Route 9W Update
9. INSURANCE: Update by William A. Smith
10. SALE OF PROPERTY (Baxter)
11. DARRIGO PROPERTY AERIAL USE
12. ROSETON HILLS SEWAGE WORKS
13. HIGHWAY DEPARTMENT:
 - A. GPS Tracking Presentation
 - B. Budget Transfer
 - C. 2 Box Sanders for New 450 Pick Ups
 - D. Plow & Sander for Class 8 Truck
 - E. Funds for Vactor Purchase Transfer to Capital Account
14. ZONING UPDATES:
 - A. Solar Law
 - B. Hotel and Motel Text Change
 - C. Sign Law Update
 - D. Driveups in B Zone
 - E. Personal Services in IB Zone
15. DATA PROCESSING: Purchase of a Desktop for New Filter Plant
16. IDA: Barton Chevrolet
17. POLICE: Budget Transfer
18. STREET LIGHTING:
 - A. Dogwood Hill Road
 - B. Susan Drive
 - C. Vermont Drive and Maine Drive
19. POWDER MILL ROAD STONE WALL REPAIR
20. BRIGHTON GREEN: Release of Securities
21. GARDNERTOWN RD CULVERT REPLACEMENT: Request for Qualifications
22. ADJOURNMENT

6

TOWN of Newburgh
Crossroads of the Northeast
Deborah A. Smith
RECEIVER OF TAXES AND ASSESSMENT
1496 Route 300
Newburgh, New York 12550

Telephone (845) 564-4553

Fax (845) 566-1432

MEMORADUM

DATE: October 29, 2014
TO: Gilbert Piaquadio, Deputy Supervisor, Acting as Supervisor
FROM: Deborah A. Smith, Receiver of Taxes
Subject: 2014 Water & Sewer Relevy

I am requesting to be on the November 12, 2014 Audit Workshop Meeting agenda for the approval of the 2014 Water & Sewer Relevy.

Town of Newburgh
Crossroads of the Northeast
 1496 Route 300
 Newburgh, NY 12550

Date: 11/06/14
 To: Gilbert Piaquadio, Acting Supervisor
 From: Deborah A. Smith, Receiver of Taxes
 Subject: Relevy Unpaid Water & Sewer

Attached are the delinquent Water & Sewer Accounts in the Town of Newburgh from July 1, 2013 through June 30, 2014. Accounts are to be transferred to the County and Town Roll. A Resolution requesting the Orange County Legislature to authorize the procedure is attached. The total to be relieved is \$369,723.79 The following breakdown applies:

	District	Amount
Edgewood	3	\$ 2,423.46
Stewart Heights	4	\$ 3,322.25
Wintergreen	5	\$ 5,315.77
Fenlo	6	\$ 814.05
Gidney Thornwood	7	\$ 35,292.50
Algonquin	8	\$ 12,235.35
Meadow Hill So	9	\$ 32,221.15
Meadow Hill No	10	\$ 22,288.22
Fleetwood *	11	\$ 9,074.41
Chadwick Lake	12	\$ 10,720.93
Green Acres	13	\$ 975.33
Chestnut Lane	14	\$ 6,440.56
Folin Heights	15	\$ 12,534.86
Union Ave	16	\$ 22,044.08
Route 52	17	\$ 30,194.18
Pinebrook	18	\$ 13,193.60
Meadow Hill West	19	\$ 13,120.59
Fostertown	20	\$ 22,704.07
Union Ave	21	\$ 4,317.37
Rt 17K	22	\$ -
Folin Heights	23	\$ 7,989.23
Crossroads	1,2, 24-34	\$ 102,501.83
Total		\$ 369,723.79

Included in above figures is Town of Montgomery \$192.57

George Woolsey, Councilman
Paul Ruggiero, Councilman
Elizabeth Greene, Councilwoman

RESOLUTION LEVYING UNPAID
WATER AND SEWER CHARGES
AND ASSESSMENTS
SECTION 198 TOWN LAW

Councilman/woman presented the following resolution which was seconded

Councilman/woman

WHEREAS, the Supervisor of the Town of Newburgh, on Nov. 12, 2014 transmitted to the Board, a statement of the UNPAID WATER AND SEWER charges and filed by the Receiver of Taxes containing a brief description of the property on which the water and sewer and assessments are unpaid, and the amounts chargeable to each, and

BE IT RESOLVED, that there be levied on the 2015 tax roll of the Town of Newburgh against the properties hereinafter described as the Unpaid Water/Sewer in the amount of \$369,723.79 so transmitted to this Board and that the amount thereof be set forth on the tax roll of the said Town of Newburgh under the name "UNPAID UTILITIES" to wit

(see schedule attached hereto) and *Town of Newburgh portion	\$ 369,531.22
--	---------------

*Town of Montgomery portion	\$ 192.57
-----------------------------	-----------

BE IT FURTHER RESOLVED, that the amount so levied shall be placed in the warrant of the Orange County Legislature to the Receiver of Taxes of the said Town of Newburgh, and that the sewer charges and water charges levied shall be collected and paid to the Supervisor of the Town of Newburgh in the same manner as general taxes until the amount thereof is paid.

The question of the adoption of the foregoing resolution was duly put to a roll call vote which resulted as follows:

George Woolsey, Councilman	VOTING
Elizabeth J. Greene, Councilwoman	VOTING
Paul L. Ruggiero, Councilman	VOTING
Gilbert J. Piaquadio, Deputy Supervisor & Councilman	VOTING

The resolution was thereupon declared duly adopted.

7A

Cindy Martinez

From: Chris Beaton <chris.beaton@pb.com>
Sent: Wednesday, November 05, 2014 10:47 AM
To: cmmartinez@townofnewburgh.org
Subject: FW: Agreement for Court House
Attachments: Connect+ Proposal.pdf; Lease Agreement.pdf; Lease Terms and Conditions.pdf; 8038GC Form.pdf

Chris Beaton, Major Account Manager
Pitney Bowes, U.S. Mailing Solutions
C: 203-892-1565 / F: 203-617-6103
chris.beaton@pb.com

From: Chris Beaton
Sent: Thursday, October 23, 2014 12:37 PM
To: rclumaccountant@townofnewburgh.org
Cc: Gil Piaquadio (councilmanpiaquadio@townofnewburgh.org)
Subject: Agreement for Court House

Hi Ron,

Thanks for the time yesterday. As we discussed I have attached the proposal and contract for the court house. Just like you folks were able to obtain a new machine while LOWERING your lease payment the court house can do the same thing.

Unfortunately, due to space limitations, they have decided to proceed with the Connect+ without the WOW.

If you have any questions please let me know – if not please sign and scan back the lease agreement and tax exempt 8038 form (do not fill this out just sign)

Thank you

Chris Beaton, Major Account Manager
Pitney Bowes, U.S. Mailing Solutions
C: 203-892-1565 / F: 203-617-6103
chris.beaton@pb.com

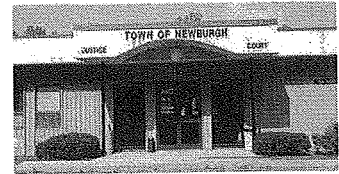

Early Equipment Replacement Opportunity

Background

- PB Announced End of Sales of Current Equipment
- Replace Current Equipment to Avoid Part Backlog
- Comply with upcoming USPS Changes
- Obtain Latest Technology

Connect+ 5lb Scale 10" Display



Specifications:

- Automatic Feed Deck with Anti-Skew Rollers
- 10" Touch Screen App Center
- Inline Electronic Rate Calculation (Weigh on the Way) Option 1
- Process 130 Letters per Minute and 70 Letters per Minute in WOW Mode
- Able to feed and seal mail 5/8" Thick AT ALL TIMES*
 - *While Sealing and In WOW Mode
- 5lb or 10lb Integrated Scale

Investment Options:

1. Weigh On the Way and 10lb Scale (Recently Purchased by Town of Newburgh)

Term	Lease Payment	Current Payment	Total Monthly Savings
51/mo	\$295	\$317	\$22 Savings per Month

2. Without Weigh on the Way and has 5lb Scale

Term	Lease Payment	Current Payment	Total Monthly Savings
51/mo	\$275	\$317	\$42 Savings per Month

PITNEY BOWES TERM RENTAL TERMS AND CONDITIONS

L1. DEFINITIONS

Capitalized terms that are not defined in this document are defined in the Pitney Bowes Terms. PBI is the manufacturer of the equipment. PBGFS, a wholly-owned subsidiary of PBI, provides you with the leasing services.

L2. AGREEMENT

L2.1 You are leasing the Equipment listed on the Order.

L2.2 **You may not cancel this Lease for any reason. All payment obligations are unconditional.**

L2.3 You authorize us to file a Uniform Commercial Code financing statement naming you as debtor/lessee with respect to the Equipment.

L3. PAYMENT TERMS

L3.1 We will invoice you in arrears each month for all payments on the Order (each, a "Monthly Payment"), except as provided in any statement of work attached to the Order. You will make each Monthly Payment by the due date shown on our invoice.

L3.2 Your Quarterly Payment may include an origination fee, amounts carried over from a previous unexpired lease, software license and maintenance fees and other charges.

L3.3 Any Meter rental fees and SLA fees (collectively "PBI Payments"), will be included with your Monthly Payment and begin with the start of the Lease Term (as defined below). After the Initial Term, your Monthly Payment will increase if your PBI Payments increase.

L3.4 Your obligations, including your obligation to pay the Monthly Payments due in any fiscal year during the term of this Agreement, shall constitute a current expense for such fiscal year and shall not constitute indebtedness within the meaning of the constitution and laws of the state in which you are located. Nothing herein shall constitute a pledge by you of any taxes or other moneys (other than moneys lawfully appropriated from time to time by or for your benefit for this Agreement) to the payment of any Total Payment due under this Agreement.

L4. EQUIPMENT OWNERSHIP

L4.1 PBI owns any Meter. Title to the Equipment shall pass to you upon installation. However, you and we agree that title shall automatically revert to us in the event of default, or termination due to your non-appropriation under Section L10.

L5. TERM

L5.1 This Agreement shall commence on the date of delivery and shall continue until the earlier of (i) termination at our option upon the occurrence of an event of default, or (ii) the occurrence of an event of a non-appropriation under Section L10, or (iii) the expiration of the Term and your payment of all Monthly Payments and other sums due and your fulfillment of all other obligations under this Agreement.

L6. SURRENDER OF EQUIPMENT

L6.1 If you default, or terminate this Agreement by non-appropriation under Section L10, you, at your expense, shall return all Equipment by delivering it to us in the same condition as when delivered to you, reasonable wear and tear excepted, to such place or on board such carrier, packed for shipping, as we may specify. Until the Equipment is returned as required above, all terms of this Agreement remain in effect including, without limitation, your obligations to make payments relating to your continued use of the Equipment and to insure the Equipment.

L7. WARRANTY AND LIMITATION OF LIABILITY

L7.1 PBI PROVIDES YOU WITH THE LIMITED WARRANTY IN THE PITNEY BOWES TERMS.

L7.2 PBGFS MAKES NO WARRANTIES, EXPRESS OR IMPLIED, INCLUDING ANY WARRANTY OF MERCHANTABILITY, FITNESS FOR A PARTICULAR PURPOSE, OR FREEDOM FROM INTERFERENCE OR INFRINGEMENT.

L7.3 WE ARE NOT LIABLE FOR ANY LOSS, DAMAGE (INCLUDING INCIDENTAL, CONSEQUENTIAL OR PUNITIVE DAMAGES), OR EXPENSE CAUSED DIRECTLY OR INDIRECTLY BY THE EQUIPMENT.

L8. EQUIPMENT OBLIGATIONS

L8.1 Condition and Repairs. You will keep the Equipment free from liens and in good repair, condition, and working order.

L8.2 Inspection. We may inspect the Equipment and related maintenance records.

L8.3 Location. You may not move the Equipment from the location specified on the Order without our prior written consent.

L9. RISK OF LOSS

L9.1 Risk of Loss.

- (a) You bear the entire risk of loss to the Equipment from the date of shipment by PBI until the Equipment is returned to, and received by, us, regardless of cause, ordinary wear and tear excepted ("Loss").
- (b) No Loss will relieve you of any of your obligations under this Lease. You must immediately notify us in writing of any Loss.
- (c) To protect the equipment from loss, you will either (i) keep the Equipment insured against Loss for its full replacement value under a comprehensive policy of insurance or other arrangement with an insurer of your choice, provided that it is reasonably satisfactory to us ("Insurance")
- (d) **YOU MUST CALL US AT 1-800-732-7222 AND PROVIDE US WITH EVIDENCE OF INSURANCE.**

L10. NON-APPROPRIATION

L10.1 You warrant that you have funds available to pay all payments until the end of your current fiscal period, and shall use your best efforts to obtain funds to pay all payments in each subsequent fiscal period through the end of the Term. If your appropriation request to your legislative body, or funding authority ("Governing Body") for funds to pay the payments is denied, you may terminate this Agreement on the last day of the fiscal period for which funds have been appropriated, upon (i) submission of documentation reasonably satisfactory to us evidencing the Governing Body's denial of an appropriation sufficient to continue this Agreement for the next succeeding fiscal period, and (ii) satisfaction of all charges and obligations under this Agreement incurred through the end of the fiscal period for which funds have been appropriated, including the return of the Equipment at your expense.

L11. REPRESENTATIONS

L11.1 You hereby represent and warrant that (a) you are a state or political subdivision thereof within the meaning of Section 103(c) of the Internal Revenue Code of 1986, as amended (the "Code"); and (b) you have the power and authority under applicable law to enter into this Agreement and you have been duly authorized to execute and deliver this Agreement and carry out your obligations hereunder. You acknowledge that a portion of each Monthly Payment you shall pay includes interest and that this Agreement is entered into based on the assumption that the interest portion of each Monthly Payment is not includable in gross income of the owner thereof for Federal income tax purposes under Section 103(a) of the Code. You shall, at all times, do and perform all acts and things necessary and within your control in order to assure that such interest component shall be so excluded. If any interest is determined not to be excludable from gross income, your Monthly Payment shall be adjusted in an amount sufficient to maintain our original after tax yield utilizing our consolidated marginal tax rate, which adjusted Monthly Payments you agree to pay as provided in this Agreement, subject to Section L10. The rate at which the interest portion of Monthly Payments is calculated is not intended to exceed the maximum rate or amount of interest permitted by applicable law. If such interest portion exceeds such maximum, then at our option, if permitted by law, the interest portion will be reduced to the legally permitted maximum amount of interest, and any excess will be used to reduce the principal amount of your obligation or be refunded to you. You shall not do (or cause to be done) any act which will cause, or by omission of any act allow, this Agreement to be an "arbitrage bond" within the meaning of Section 148(a) of the Code or a "private activity bond" within the meaning of Section 141(a) of the Code. At the time of your execution of this Agreement, you shall provide us with a properly prepared and executed copy of the appropriate US Treasury Form 8038-G or 8038-GC and you appoint us as your agent for the purpose of maintaining a registration system as required by Section 149(a) of the Code. This Section shall survive the termination of this Agreement.

L12. MISCELLANEOUS

L12.1 If more than one lessee is named in this Lease, liability is joint and several.

L12.2 **YOU MAY NOT ASSIGN OR SUBLET THE EQUIPMENT, THE METER OR THIS LEASE WITHOUT OUR PRIOR WRITTEN CONSENT, WHICH WILL NOT BE UNREASONABLY WITHHELD.**

L12.3 We may sell, or assign all or any part of this Lease or the Equipment. Any sale or assignment will not affect your rights or obligations under this Agreement.

Information Return for Small Tax-Exempt Governmental Bond Issues, Leases, and Installment Sales

Under Internal Revenue Code section 149(e)

Caution: If the issue price of the issue is \$100,000 or more, use Form 8038-G.

Part I Reporting Authority Check Box if Amended Return
1. Issuer's name: TOWN OF NEWBURGH TOWN JUSTICE
2. Issuer's employer identification number (EIN)
3. Number and street (or P.O. box if mail is not delivered to street address): 311 ROUTE 32
4. City, town, or post office, state, and ZIP code: NEWBURGH, NY 12550-8856
5. Report number (For IRS Use Only)
6. Name and title of officer or other employee of issuer or designated contact person whom the IRS may call for more information
7. Telephone number of officer or legal representative

Part II Description of Obligations Check one: a single issue [X] or a consolidated return []
8a Issue price of obligation(s)
b Issue date (single issue) or calendar date (consolidated)
9 Amount of the reported obligation(s) on line 8a that is:
a For leases for Vehicles
b For leases for office equipment
c For leases for real property
d For leases for other (see instructions)
e For bank loans for vehicles
f For bank loans for office equipment
g For bank loans for real property
h For Bank loans for other (see Instructions)
i Used to refund prior issue(s)
j Representing a loan from the proceeds of another tax-exempt obligation (for example, bond bank)
k Other
10 If the issuer has designated any issue under section 265(b)(3)(B)(i)(III), (small issuer exceptions), check this box
11 If the issuer has elected to pay a penalty in lieu of arbitrage rebate, check this box
12 Vendor's or bank's name: PITNEY BOWES INC
13 Vendor's or bank's employer identification number: 060495050

Signature and Consent
Under penalties of perjury, I declare that I have examined this return and accompanying schedules and statements, and to the best of my knowledge and belief, they are true, correct, and complete. I further declare that I consent to the IRS's disclosure of the issuer's return information, as necessary to process this return, to the person(s) that I have authorized above.
Signature of issuer's authorized representative Date Type or print name and title

Paid Preparer's Use Only
Print/Type preparer's name Preparer's signature Date Check if self-employed PTIN
Firm's name Firm's EIN
Firm's address Phone no.

General Instructions

Section references are to the Internal Revenue Code unless otherwise noted.

What's New

The IRS has created a page on IRS.gov for information about the Form 8038 series and its instructions, at www.irs.gov/form8038. Information about any future developments affecting the Form 8038 series (such as legislation enacted after we release it) will be posted on that page.

Purpose of Form

Form 8038-GC is used by the issuers of tax-exempt governmental obligations to provide the IRS with the information required by section 149(e) and to monitor the requirements of sections 141 through 150.

Who Must File

Issuers of tax-exempt governmental obligations with issue prices of less than \$100,000 must file Form 8038-GC.

Issuers of a tax-exempt governmental obligation with an issue price of \$100,000 or more must file Form 8038-G, Information Return for Tax-Exempt Governmental Obligations.

Filing a separate return for a single issue.

Issuers have the option to file a separate Form 8038-GC for any tax-exempt governmental obligation with an issue price of less than \$100,000.

An issuer of a tax-exempt bond used to finance construction expenditures must file a separate Form 8038-GC for each issue to give notice to the IRS that an election was made to

pay a penalty in lieu of arbitrage rebate (see the line 11 instructions).

Filing a consolidated return for multiple issues.

For all tax-exempt governmental obligations with issue prices of less than \$100,000 that are not reported on a separate Form 8038-GC, an issuer must file a consolidated information return including all such issues issued within the calendar year.

Thus, an issuer may file a separate Form 8038-GC for each of a number of small issues and report the remainder of small issues issued during the calendar year on one consolidated Form 8038-GC. However, if the issue is a construction issue, a separate Form 8038-GC must be filed to give the IRS notice of the election to pay a penalty in lieu of arbitrage rebate.

When To File

To file a separate return for a single issue, file Form 8038-GC on or before the 15th day of the second calendar month after the close of the calendar quarter in which the issue is issued.

To file a consolidated return for multiple issues, file Form 8038-GC on or before February 15th of the calendar year following the year in which the issue is issued.

Late filing. An issuer may be granted an extension of time to file Form 8038-GC under section 3 of Rev. Proc. 2002-48, 2002-37 I.R.B. 531, if it is determined that the failure to file on time is not due to willful neglect. Type or print at the top of the form, "Request for Relief under section 3 of Rev. Proc. 2002-48." Attach to the Form 8038-GC a letter briefly stating why the form was not submitted to the IRS on time. Also indicate whether the obligation in question is under examination by the IRS. Do not submit copies of any bond documents, leases, or installment sale documents. See *Where To File* next.

Where To File

File Form 8038-GC, and any attachments, with the Department of the Treasury, Internal Revenue Service Center, Ogden, UT 84201.

Private delivery services. You can use certain private delivery services designated by the IRS to meet the "timely mailing as timely filing/paying" rule for tax returns and payments. These private delivery services include only the following:

- DHL Express (DHL): DHL Same Day Service.
- Federal Express (FedEx): FedEx Priority Overnight, FedEx Standard Overnight, FedEx 2Day, FedEx International Priority, and FedEx International First.
- United Parcel Service (UPS): UPS Next Day Air, UPS Next Day Air Saver, UPS 2nd Day Air, UPS 2nd Day Air A.M., UPS Worldwide Express Plus, and UPS Worldwide Express.

The private delivery service can tell you how to get written proof of the mailing date.

Other Forms That May Be Required

For rebating arbitrage (or paying a penalty in lieu of arbitrage rebate) to the Federal Government, use Form 8038-T, Arbitrage Rebate, Yield Reduction and Penalty in Lieu of Arbitrage Rebate. For private activity bonds, use Form 8038, Information Return for Tax-Exempt Private Activity Bond Issues.

For a tax-exempt governmental obligation with an issue price of \$100,000 or more, use Form 8038-G.

Rounding to Whole Dollars

You may show the money items on this return as whole-dollar amounts. To do so, drop any amount less than 50 cents and increase any amount from 50 to 99 cents to the next higher dollar.

Definitions

Obligations. This refers to a single tax-exempt governmental obligation if Form 8038-GC is used for separate reporting or to

multiple tax-exempt governmental obligations if the form is used for consolidated reporting.

Tax-exempt obligation. This is any obligation including a bond, installment purchase agreement, or financial lease, on which the interest is excluded from income under section 103.

Tax-exempt governmental obligation. A tax-exempt obligation that is not a private activity bond (see below) is a tax-exempt governmental obligation. This includes a bond issued by a qualified volunteer fire department under section 150(e).

Private activity bond. This includes an obligation issued as part of an issue in which:

- More than 10% of the proceeds are to be used for any private activity business use, and
- More than 10% of the payment of principal or interest of the issue is either (a) secured by an interest in property to be used for a private business use (or payments for such property) or (b) to be derived from payments for property (or borrowed money) used for a private business use.

It also includes a bond, the proceeds of which (a) are to be used to make or finance loans (other than loans described in section 141(c)(2)) to persons other than governmental units and (b) exceeds the lesser of 5% of the proceeds or \$5 million.

Issue. Generally, obligations are treated as part of the same issue only if they are issued by the same issuer, on the same date, and as part of a single transaction, or a series of related transactions. However, obligations issued during the same calendar year (a) under a loan agreement under which amounts are to be advanced periodically (a "draw-down loan") or (b) with a term not exceeding 270 days, may be treated as part of the same issue if the obligations are equally and ratably secured under a single indenture or loan agreement and are issued under a common financing arrangement (for example, under the same official statement periodically updated to reflect changing factual circumstances). Also, for obligations issued under a draw-down loan that meets the requirements of the preceding sentence, obligations issued during different calendar years may be treated as part of the same issue if all of the amounts to be advanced under the draw-down loan are reasonably expected to be advanced within 3 years of the date of issue of the first obligation. Likewise, obligations (other than private activity bonds) issued under a single agreement that is in the form of a lease or installment sale may be treated as part of the same issue if all of the property covered by that agreement is reasonably expected to be delivered within 3 years of the date of issue of the first obligation.

Arbitrage rebate. Generally, interest on a state or local bond is not tax-exempt unless the issuer of the bond rebates to the United States arbitrage profits earned from investing proceeds of the bond in higher yielding nonpurpose investments. See section 148(f).

Construction issue. This is an issue of tax-exempt bonds that meets both of the following conditions:

1. At least 75% of the available construction proceeds of the issue are to be used for construction expenditures with respect to property to be owned by a governmental unit or a 501(c)(3) organization, and

2. All of the bonds that are part of the issue are qualified 501(c)(3) bonds, bonds that are not private activity bonds, or private activity bonds issued to finance property to be owned by a governmental unit or a 501(c)(3) organization.

In lieu of rebating any arbitrage that may be owed to the United States, the issuer of a construction issue may make an irrevocable election to pay a penalty. The penalty is equal to 1-1/2% of the amount of construction proceeds that do not meet certain spending requirements. See section 148(f)(4)(C) and the Instructions for Form 8038-T.

Specific Instructions

In general, a Form 8038-GC must be completed on the basis of available information and reasonable expectations as of the date of issue. However, forms that are filed on a consolidated basis may be completed on the basis of information readily available to the issuer at the close of the calendar year to which the form relates, supplemented by estimates made in good faith.

Part I—Reporting Authority

Amended return. An issuer may file an amended return to change or add to the information reported on a previously filed return for the same date of issue. If you are filing to correct errors or change a previously filed return, check the "Amended Return" box in the heading of the form.

The amended return must provide all the information reported on the original return, in addition to the new corrected information. Attach an explanation of the reason for the amended return and write across the top "Amended Return Explanation."

Line 1. The issuer's name is the name of the entity issuing the obligations, not the name of the entity receiving the benefit of the financing. In the case of a lease or installment sale, the issuer is the lessee or purchaser.

Line 2. An issuer that does not have an employer identification number (EIN) should apply for one on Form SS-4, Application for Employer Identification Number. You can get this form on the IRS website at IRS.gov or by calling 1-800-TAX-FORM (1-800-829-3676). You may receive an EIN by telephone by following the instructions for Form SS-4.

Lines 3 and 4. Enter the issuer's address or the address of the designated contact person listed on line 6. If the issuer wishes to use its own address and the issuer receives its mail in care of a third party authorized representative (such as an accountant or attorney), enter on the street address line "C/O" followed by the third party's name and street address or P.O. box. Include the suite, room, or other unit number after the street address. If the post office does not deliver mail to the street address and the issuer has a P.O. box, show the box number instead of the

street address. If a change in address occurs after the return is filed, use Form 8822, Change of Address, to notify the IRS of the new address.

Note. The address entered on lines 3 and 4 is the address the IRS will use for all written communications regarding the processing of this return, including any notices. By authorizing a person other than an authorized officer or other employee of the issuer to communicate with the IRS and whom the IRS may contact about this return, the issuer authorizes the IRS to communicate directly with the individual listed on line 6, whose address is entered on lines 3 and 4 and consents to disclose the issuer's return information to that individual, as necessary, to process this return.

Line 5. This line is for IRS use only. Do not make any entries in this box.

Part II—Description of Obligations

Check the appropriate box designating this as a return on a single issue basis or a consolidated return basis.

Line 8a. The issue price of obligations is generally determined under Regulations section 1.148-1(b). Thus, when issued for cash, the issue price is the price at which a substantial amount of the obligations are sold to the public. To determine the issue price of an obligation issued for property, see sections 1273 and 1274 and the related regulations.

Line 8b. For a single issue, enter the date of issue (for example, 03/15/2010 for a single issue issued on March 15, 2010), generally the date on which the issuer physically exchanges the bonds that are part of the issue for the underwriter's (or other purchaser's) funds; for a lease or installment sale, enter the date interest starts to accrue. For issues reported on a consolidated basis, enter the first day of the calendar year during which the obligations were issued (for example, for calendar year 2010, enter 01/01/2010).

Lines 9a through 9h. Complete this section if property other than cash is exchanged for the obligation, for example, acquiring a police car, a fire truck, or telephone equipment through a series of monthly payments. (This type of obligation is sometimes referred to as a "municipal lease.") Also complete this section if real property is directly acquired in exchange for an obligation to make periodic payments of interest and principal.

Do not complete lines 9a through 9d if the proceeds of an obligation are received in the form of cash even if the term "lease" is used in the title of the issue. For lines 9a through 9d, enter the amount on the appropriate line that represents a lease or installment purchase. For line 9d, enter the type of item that is leased. For lines 9e through 9h, enter the amount on the appropriate line that represents a bank loan. For line 9h, enter the type of bank loan.

Lines 9i and 9j. For line 9i, enter the amount of the proceeds that will be used to pay principal, interest, or call premium on any other issue of bonds, including proceeds that will be used to fund an escrow account for this purpose. Several lines may apply to a particular obligation. For example, report on lines 9i and 9j obligations used to refund prior issues which represent loans from the proceeds of another tax-exempt obligation.

Line 9k. Enter on line 9k the amount on line 8a that does not represent an obligation described on lines 9a through 9j.

Line 10. Check this box if the issuer has designated any issue as a "small issuer exception" under section 265(b)(3)(B)(i)(III).

Line 11. Check this box if the issue is a construction issue and an irrevocable election to pay a penalty in lieu of arbitrage rebate has been made on or before the date the bonds were issued. The penalty is payable with a Form 8038-T for each 6-month period after the date the bonds are issued. Do not make any payment of penalty in lieu of rebate with Form 8038-GC. See Rev. Proc. 92-22, 1992-1 C.B. 736, for rules regarding the "election document."

Line 12. Enter the name of the vendor or bank who is a party to the installment purchase agreement, loan, or financial lease. If there are multiple vendors or banks, the issuer should attach a schedule.

Line 13. Enter the employer identification number of the vendor or bank who is a party to the installment purchase agreement, loan, or financial lease. If there are multiple vendors or banks, the issuer should attach a schedule.

Signature and Consent

An authorized representative of the issuer must sign Form 8038-GC and any applicable certification. Also print the name and title of the person signing Form 8038-GC. The authorized representative of the issuer signing this form must have the authority to consent to the disclosure of the issuer's return information, as necessary to process this return, to the person(s) that has been designated in this form.

Note. If the issuer authorizes in line 6 the IRS to communicate with a person other than an officer or other employee of the issuer, (such authorization shall include contact both in writing regardless of the address entered in lines 3 and 4, and by telephone) by signing this form, the issuer's authorized representative consents to the disclosure of the issuer's return information, as necessary to process this return, to such person.

Paid Preparer

If an authorized representative of the issuer filled in its return, the paid preparer's space should remain blank. Anyone who prepares the return but does not charge the organization should not sign the return. Certain others who prepare the return should not sign. For example, a regular, full-time employee of the issuer, such as a clerk, secretary, etc., should not sign.

Generally, anyone who is paid to prepare a return must sign it and fill in the other blanks in the *Paid Preparer Use Only* area of the return. A paid preparer cannot use a social security number in the *Paid Preparer Use Only* box. The paid preparer must use a preparer tax identification number (PTIN). If the paid preparer is self-employed, the preparer should enter his or her address in the box.

The paid preparer must:

- Sign the return in the space provided for the preparer's signature, and
- Give a copy of the return to the issuer.

Paperwork Reduction Act Notice

We ask for the information on this form to carry out the Internal Revenue laws of the United States. You are required to give us the information. We need it to ensure that you are complying with these laws.

You are not required to provide the information requested on a form that is subject to the Paperwork Reduction Act unless the form displays a valid OMB control number. Books or records relating to a form or its instructions must be retained as long as their contents may become material in the administration of any Internal Revenue law. Generally, tax returns and return information are confidential, as required by section 6103.

The time needed to complete and file this form will vary depending on individual circumstances. The estimated average time is:

Learning about the law or the form 4 hr., 46 min.

Preparing the form 2 hr., 22 min.

Copying, assembling, and sending the form to the IRS . 2 hr., 34 min.

If you have comments concerning the accuracy of these time estimates or suggestions for making this form simpler, we would be happy to hear from you. You can write to the Internal Revenue Service, Tax Products Coordinating Committee, SE:W:CAR:MP:T:M:S, 1111 Constitution Ave. NW, IR-6526, Washington, DC 20224. Do not send the form to this address. Instead, see *Where To File*.

7B

**INTRODUCTORY LOCAL LAW #__ OF 2014
PROVIDING FOR THE RESIDENCY AND ELECTOR REQUIREMENTS
FOR COURT OFFICERS
OF THE TOWN OF NEWBURGH**

BE IT ENACTED by the Town Board of the Town of Newburgh as follows:

SECTION 1 - TITLE

This Local Law shall be referred to as “A Local Law Providing for the Residency and Elector Requirements for Court Officers of the Town of Newburgh”.

SECTION 2 – PURPOSE AND AUTHORITY

The purpose of this Local Law is to add Court Officers to the list of Town officers who are not required to reside in or be electors of the Town of Newburgh provided they reside within the geographical limitations set forth in the Municipal Code. This local law is adopted pursuant to Municipal Home Rule Law, §10(l)(ii)(a)(1) which grants to local governments the authority to enact local laws regarding the qualifications of local officers. This local law recognizes that the State Legislature previously amended Public Officers Law, §3 expanding the residency requirements for any appointed public office, thereby rendering Public Officers Law a special law with respect to any appointed town officer.

SECTION 3 – RESIDENCY REQUIREMENTS AMENDMENT

Section 42-3 entitled “Eligibility for certain Town offices” of Chapter 42 entitled “Residency Requirements of the Town of Newburgh Municipal Code is hereby amended to read as follows:

“§42-3 Eligibility for Certain Town Offices. Notwithstanding any other provision of law to the contrary, individuals otherwise qualified, appointed to hold the following offices, shall not be required to be a resident or an elector of the Town of Newburgh at the time of appointment and during the term of office, but must reside with the County of Orange or an adjoining county within the State of New York, provided the individual’s residence in an adjoining county is within thirty (30) linear miles of the nearest boundary of the Town:

- A. Second (Additional) Deputy Town Clerk ;and
- B. Second (Additional) Deputy Receiver of Taxes and Assessments and
- C. Court Officers.”

SECTION 4 - SUPERSESSION

This local law shall supersede the requirement of local residency set forth in § 3, Subdivision 1, of the Public Officers Law of the State of New York and shall also supersede the requirement of being a local elector set forth in § 23, Subdivision 1, of the Town Law of the State of New York with respect to the certain Town officers specified in Section 42-3 below.

SECTION 5 - INCONSISTENCY

Any other Local Laws and ordinances of the Town of Newburgh that are inconsistent with the provisions of this Local Law are hereby repealed; provide however, that such repeal shall only be to the extent of such inconsistency and in all other respects this Local Law shall be in addition to such other Local Laws or ordinances regulating and governing the subject matter covered by the Local Law.

SECTION 6 - UNCONSTITUTIONALITY OR ILLEGALITY

If any clause, sentence, paragraph, word, section or part of this Local Law shall be adjudged by any court of competent jurisdiction to be unconstitutional, illegal or invalid, such judgment shall not affect, impair or invalidate the remainder thereof, but shall be confined in its operation to the clause, sentence, paragraph, word section or part thereof directly involved in the controversy in which such judgment shall have been rendered.

SECTION 7 - EFFECTIVE DATE

This Local Law shall take effect immediately when it is filed in the Office of the New York State Secretary of State in accordance with Section 27 of the Municipal Home Rule Law.

84

TOWN OF NEWBURGH

Crossroads of the Northeast

OLD TOWN HALL
308 GARDNERTOWN ROAD
NEWBURGH, NEW YORK 12550

CODE COMPLIANCE DEPT.
TELEPHONE 845-564-7801
FAX LINE 845-564-7802

November 7, 2014

To: Acting Supervisor Piaquadio and Town Board Members

From: Thomas Dubetsky, Asst. Fire Inspector

Re: Proposed Unsafe Building 19 Wintergreen Ave.
SBL – 67-3-9

Following an inspection of the conditions at the above named structure pursuant to Section 75-3 of the Town of Newburgh Municipal Code the above identified structure is being submitted to the Town Board for adoption of an Unsafe Building Resolution per Section 75-4.

Based on an examination of the structure it is the finding of the Code Compliance Department that the following structural deficiencies apply as stipulated in section 75-2 under the "Criteria for determination of unsafe conditions".

E. Those which have become or are so dilapidated, decayed, unsafe, or unsanitary or which so utterly fail to provide the amenities essential to decent living that they are unfit for human habitation or are likely to cause sickness or disease so as to work injury to the health, morals, safety or general welfare of those living therein.

H. Those which have parts thereof which are so attached that they may fall and injure members of the public or property.

I. Those which because of their condition are unsafe, unsanitary, or dangerous to the health, morals, safety or general welfare of the people of this town.

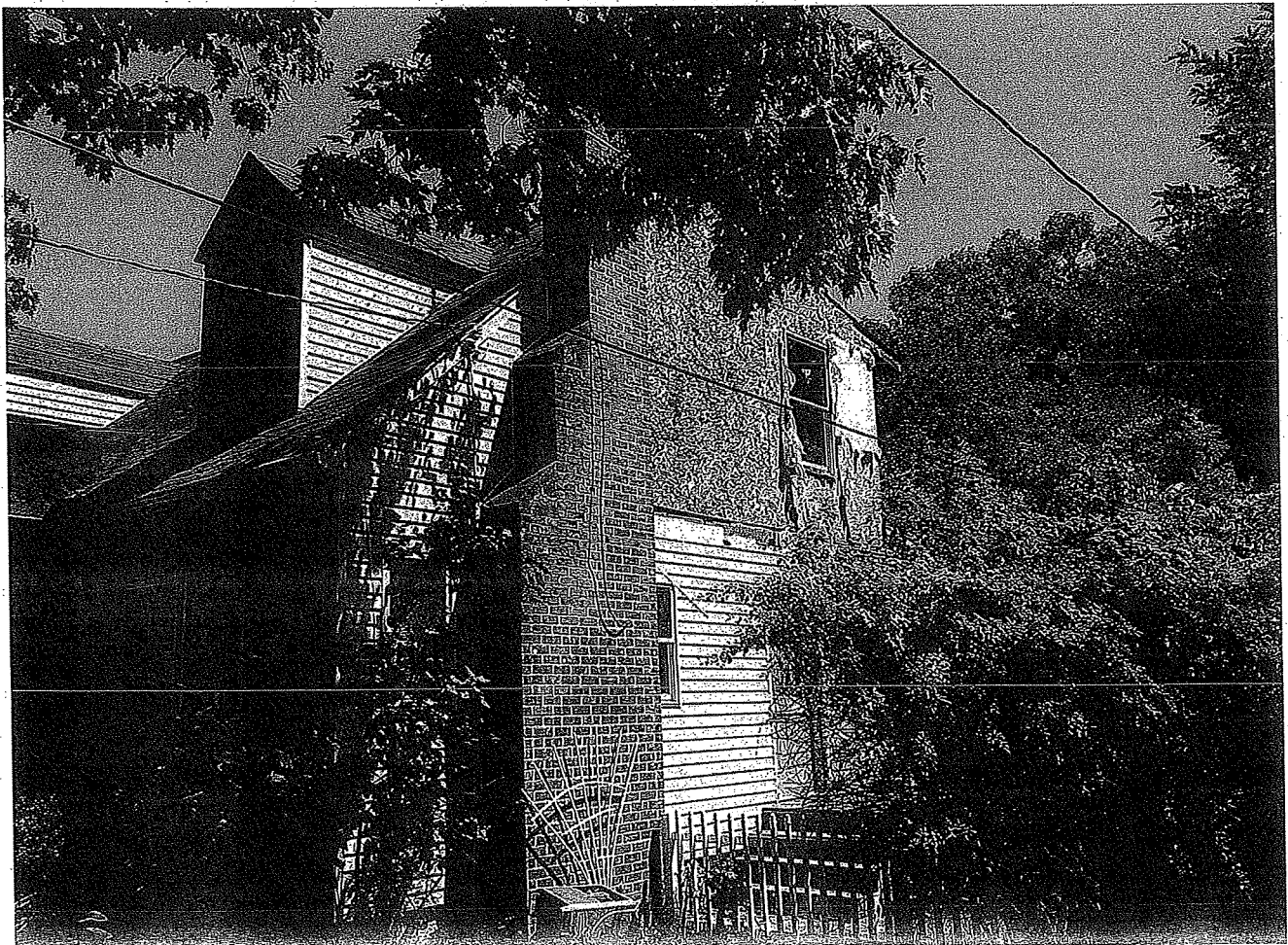

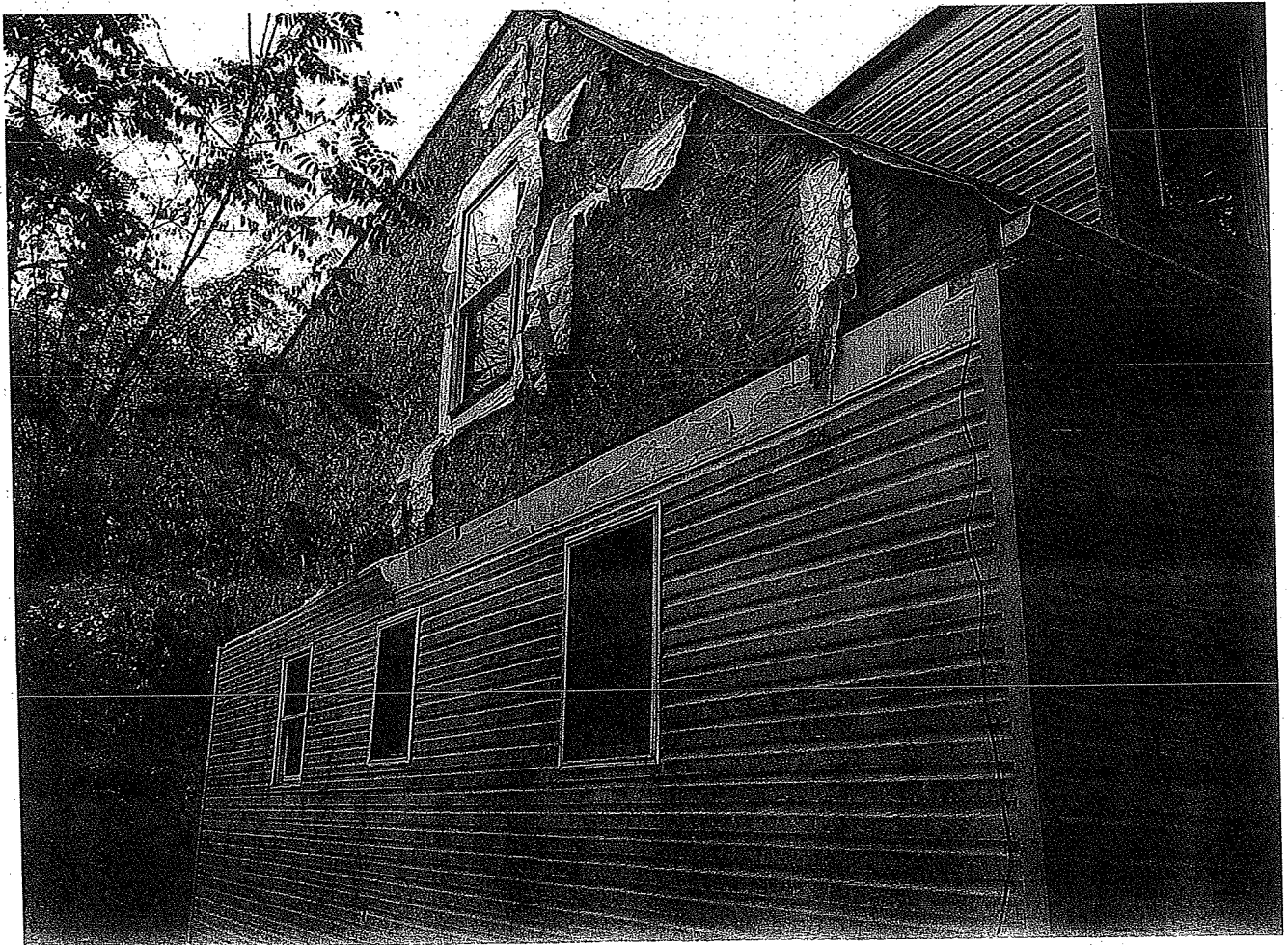



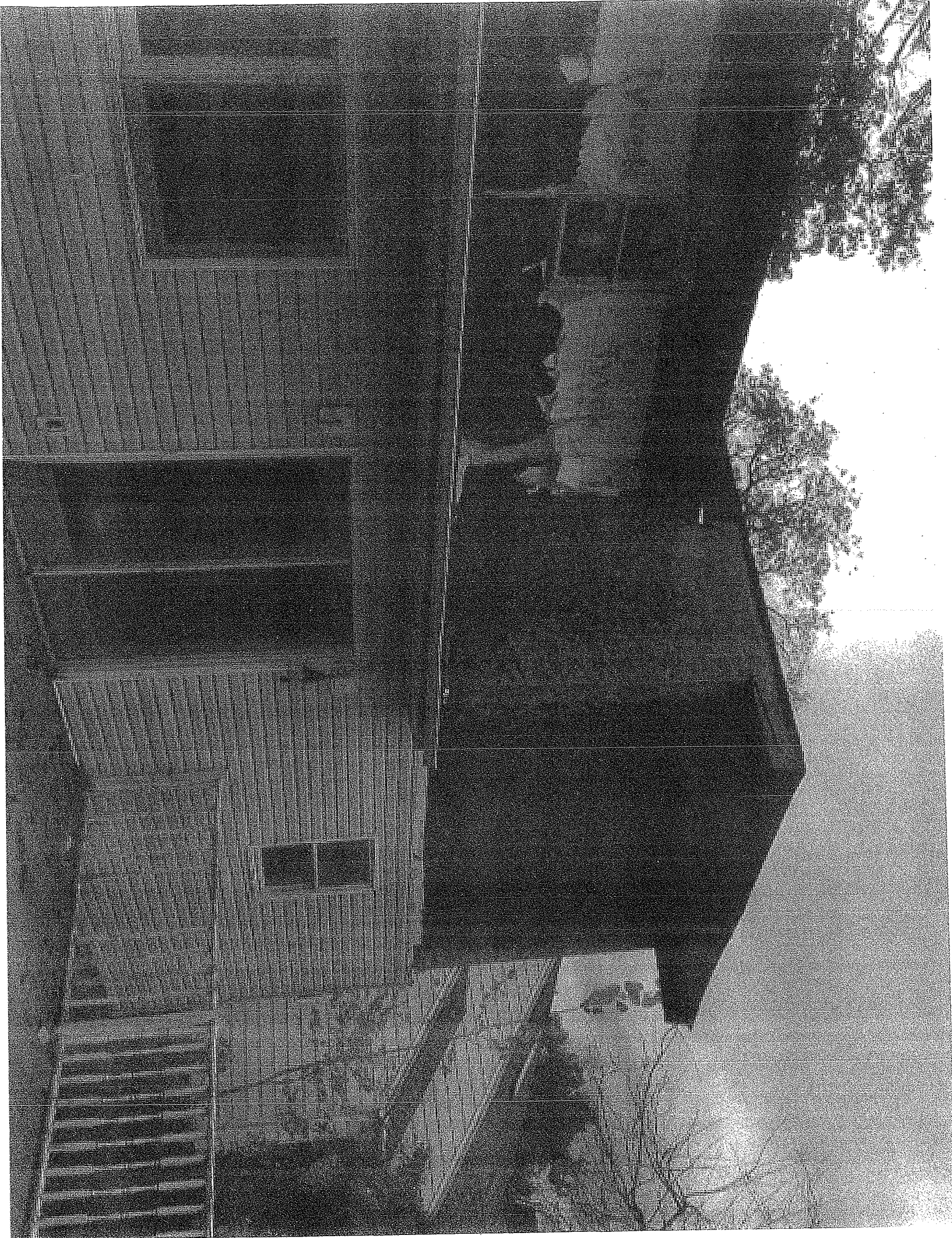



8A

Unsafe Building
Town of Newburgh
Tax Map Section: 67-3-9
19 Wintergreen Ave.
Code Compliance Department
Town of Newburgh
308 Gardnertown Rd.
Newburgh, New York 12550

Dear William M. Friberg / Wells Fargo Bank,

With reference to the above described property, the house has been declared by the Town Board of the Town of Newburgh to be unsafe due to structural instability brought about by uncompleted construction and abandonment.

This notice as of this date includes an ORDER to make safe and secure or to remove said building shall commence within twenty (20) days of the serving notice as hereinafter provided, and shall be completed within forty – five (45) days thereafter.

That in the event of neglect or refusal of the persons served with this notice and order to comply with same, the Town Board will cause said building to be demolished and removed.

That the land on which said buildings or structures are located will be assessed for all costs and expenses incurred by the Town in connection with the proceedings to remove or secure including the cost of actually removing the said building or structure and/or a special proceeding to collect said cost including legal fees, may be instituted by the Town Board.

That on the 1st day of December 2014 at 7:00pm, at the Town Hall, 1496 Rte. 300 in the Town of Newburgh, a hearing will be held before the Town Board at which time and place you will be given an opportunity to be heard in response to the evidence presented by the Town.

Attached is a certified copy of the “Resolution Determining Unsafe Building and Order to Make Safe or Remove” as passed by the Town Board, Town of Newburgh, on the 12th day of November 2014.

This was certified by the Town Clerk on the 13th day of November 2014

Your full cooperation in this matter will be appreciated and expected.

Dated: November 12th, 2014

Thomas Dubetsky
Asst. Fire Inspector/Safety Officer
Town of Newburgh

At a meeting of the Town Board
held at 1496 Rte. 300, in the Town of
Newburgh on the 12th day of
November 2014 at 7:00 pm

Present:

Gilbert Piaquadio, Councilman/ Acting Supervisor
Elizabeth Greene, Councilwoman
Paul Ruggerio, Councilman
George Woolsey, Councilman

RESOLUTION DETERMINING
UNSAFE BUILDINGS AND
ORDER TO MAKE SAFE OR
REMOVE

WHERE AS, it was reported to the Town Board that a building addressed as 19 Wintergreen Ave. in the Town of Newburgh owned by William Friberg/ Wells Fargo Bank, said premises designated as Section 67, Block 3, Lot 9 , might be dangerous or unsafe to the public and

WHERE AS, the Town Board ordered the Code Compliance Dept. to make an inspection and report of said site, and

WHERE AS, the Code Compliance Dept. did so inspect and deliver a report on said building to said Town Board on the 12th , day of November 2014 and

WHERE AS, the Town Board has carefully considered said report.

NOW, THEREFORE, BE IT RESOLVED, that the Town Board of the Town of Newburgh declares that the building located on a portion of 19 Wintergreen Ave. premises owned by William Friberg/ Wells Fargo Bank said premises designated as Section 67, Block 3, Lot 9 is unsafe and dangerous and comes within the confines of Chapter 75, Subsection 2, of the Town of Newburgh Municipal Code.

BE IT FURTHER RESOLVED AND ORDERED, that said building shall be made safe or removed and that work shall commence within (20) days of the serving of notice of this Resolution and shall be completed (45) days thereafter.

BE IT FURTHER RESOLVED AND ORDERED THAT a notice containing the information required under Section 75.5A.

The foregoing resolution was duly put to a vote on roll call which resulted as follows:

Gilbert Piaquadio voting
Elizabeth Greene voting
Paul Ruggerio voting
George Woolsey voting

WHERE AS, a Hearing has been scheduled for the 1st of December 2014 at 7:00 pm for the hearing of all disputes and challenges to the claiming of Unsafe Building status for the structure listed as 19 Wintergreen Ave. in the Town of Newburgh.

TOWN OF NEWBURGH

Crossroads of the Northeast

OLD TOWN HALL
308 GARDNERTOWN ROAD
NEWBURGH, NEW YORK 12550

82

CODE COMPLIANCE DEPT.
TELEPHONE 845-564-7801
FAX LINE 845-564-7802

October 31, 2014

To: Acting Supervisor Piaquadio and Town Board Members

From: Thomas Dubetsky, Asst. Fire Inspector

Re: Proposed Unsafe Building 5228 Rte. 9W
SBL - 27-2-25

Following an inspection of the structural conditions at the above named structure pursuant to Section 75-3 of the Town of Newburgh Municipal Code the above identified structure is being submitted to the Town Board for adoption of an Unsafe Building Resolution per Section 75-4.

Based on an examination of the structure it is the finding of the Code Compliance Department that the following structural deficiencies apply as stipulated in section 75-2 under the "Criteria for determination of unsafe conditions".

- B. Those which exclusive of the foundation, show thirty-three percent (33%) or more of damage or deterioration of the supporting member or members or fifty (50%) of damage or deterioration of the nonsupporting enclosing or outside walls or covering.
- C. Those which have improperly distributed loads upon the floors or roofs or in which the same are overloaded or which have insufficient strength to be reasonably safe for the purpose used.
- D. Those which have been damaged by fire, wind or other causes so as to have become dangerous to life, safety, morals or the general health and welfare of the occupants or the people of the Town of Newburgh.
- E. Those which have become or are so dilapidated, decayed, unsafe, or unsanitary or which so utterly fail to provide the amenities essential to decent living that they are unfit for human habitation or are likely to cause sickness or disease so as to work injury to the health, morals, safety or general welfare of those living therein.

APPROVED
NOV 3-2014

At a meeting of the Town Board
held at 1496 Rte. 300, in the Town of
Newburgh on the 3rd day of
November 2014 at 7:00 pm

Present:

Gilbert Piaquadio, Councilman/ Acting Supervisor
Elizabeth Greene, Councilwoman
Paul Ruggiero, Councilman
George Woolsey, Councilman

**RESOLUTION DETERMINING
UNSAFE BUILDINGS AND
ORDER TO MAKE SAFE OR
REMOVE**

WHERE AS, it was reported to the Town Board that a building addressed as 5228 Rte. 9W in the Town of Newburgh owned by Rayjas Realty Corp., said premises designated as Section 27, Block 2, Lot 25 , might be dangerous or unsafe to the public and

WHERE AS, the Town Board ordered the Code Compliance Dept. to make an inspection and report of said site, and

WHERE AS, the Code Compliance Dept. did so inspect and deliver a report on said building to said Town Board on the 31st , day of October 2014 and

WHERE AS, the Town Board has carefully considered said report.

NOW, THEREFORE, BE IT RESOLVED, that the Town Board of the Town of Newburgh declares that the building located on a portion of 5228 Rte.9W. premises owned by Rayjas Realty Corp. said premises designated as Section 27, Block 2, Lot 25 is unsafe and dangerous and comes within the confines of Chapter 75, Subsection 2, of the Town of Newburgh Municipal Code.

BE IT FURTHER RESOLVED AND ORDERED, that said building shall be made safe or removed and that work shall commence within (20) days of the serving of notice of this Resolution and shall be completed (45) days thereafter.

BE IT FURTHER RESOLVED AND ORDERED THAT a notice containing the information required under Section 75.5A.

The foregoing resolution was duly put to a vote on roll call which resulted as follows:

Gilbert Piaquadio voting
Elizabeth Greene voting
Paul Ruggerio voting
George Woolsey voting

WHERE AS, a Hearing has been scheduled for the 12th of November 2014 at 7:00 pm for the hearing of all disputes and challenges to the claiming of Unsafe Building status for the structure listed as 5228 Rte. 9W in the Town of Newburgh.

Aerial Challenge Course at Darrigo Farm

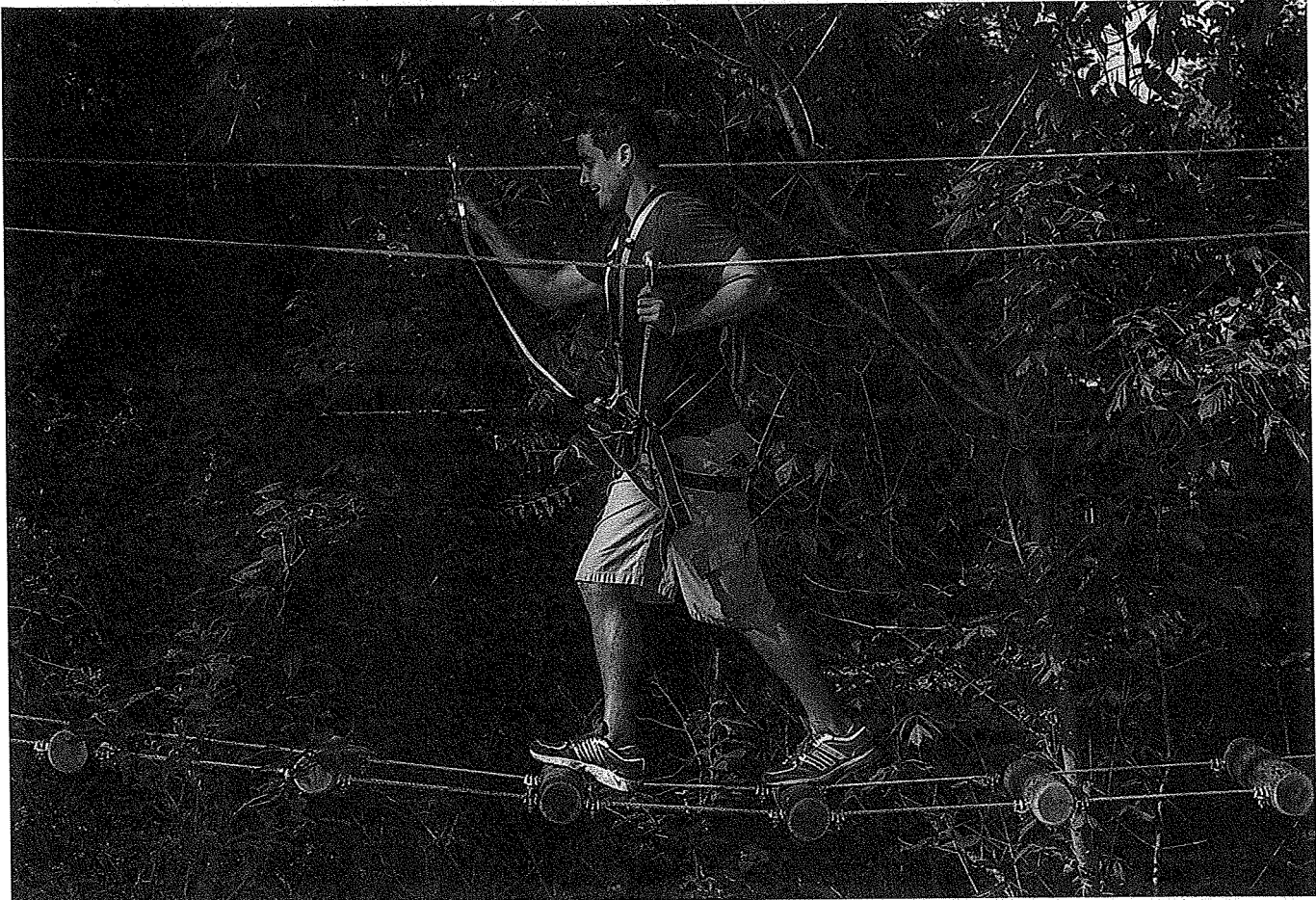

Challenge courses bring people to new heights in a safety first setting. From the beginning of the course customers are harnessed up and are safely connected to the course at all times through a self belay system, preventing a fall. The courses are designed for ages 7 to senior. Guests must navigate through obstacles between platforms while enduring both mental and physical challenges.

5 courses 60 elements

Quick Facts	Involved Parties
<ul style="list-style-type: none">• Utilizing both trees and telephone poles• Fully outdoor• Harness and clipping system always keeps customers connected to course• Spring – Fall operating season• 3 hour ticket for 75 harnesses• Compliant with ACCT, ASTM, and all relevant ANSI standards	<ul style="list-style-type: none">• NYS Geotech Engineer• NYS Arborist• NYS Structural Engineer• Certified ACCT Designer/Builder• Third Party Safety Inspector• NYS Dept of Health & Labor



Clip on at the start

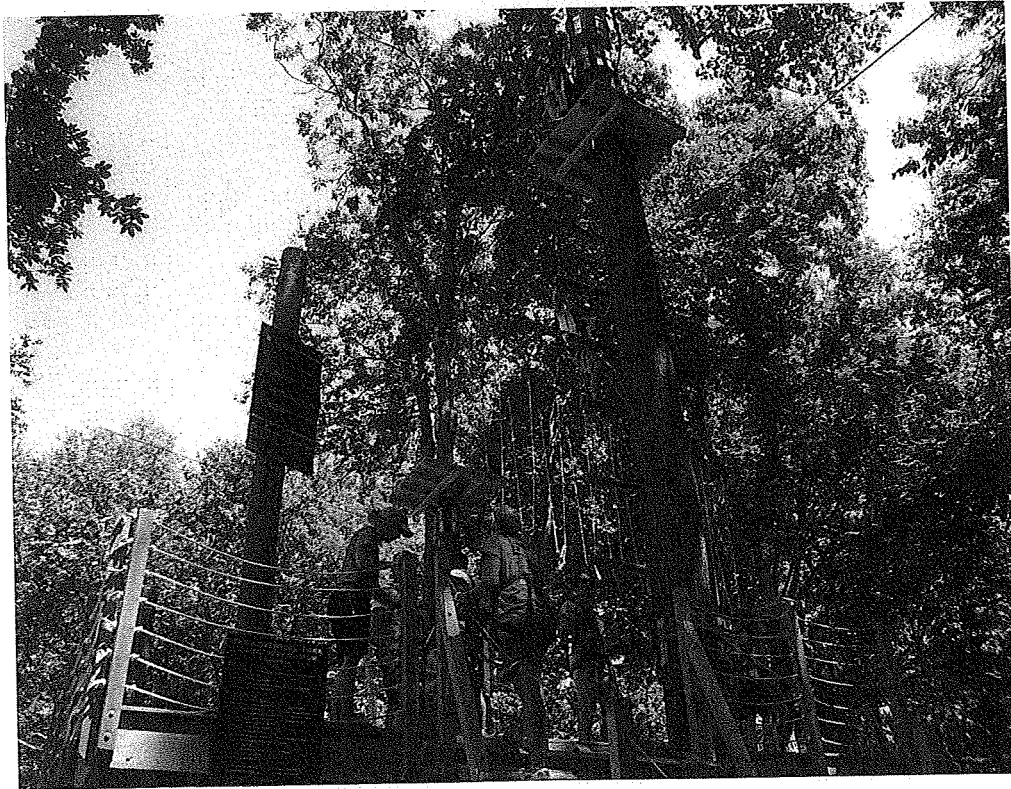

Choose your course from the starting platform







Aerial Challenge Course

Parking

Google

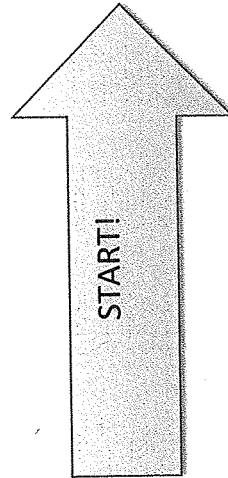
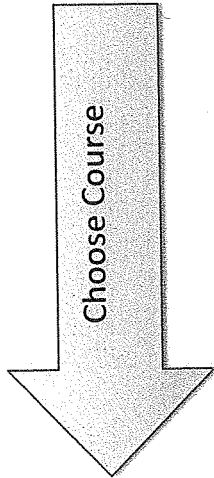
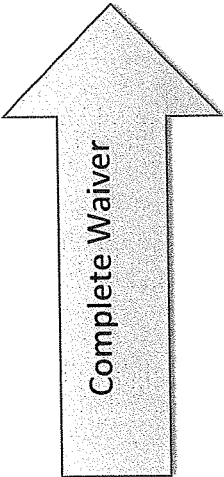
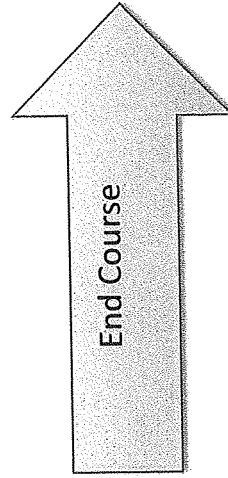
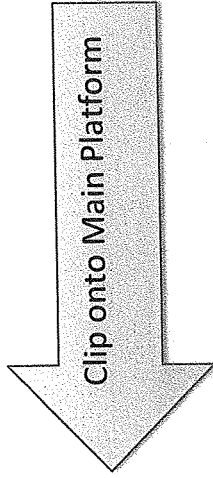
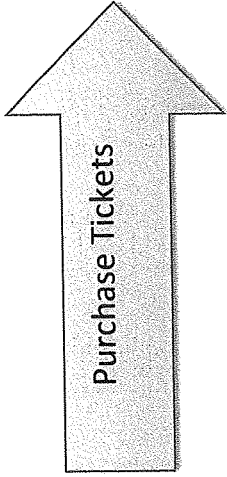
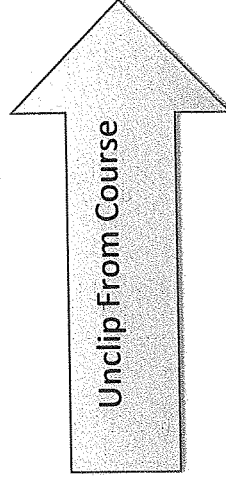
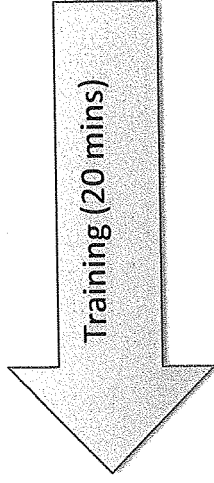
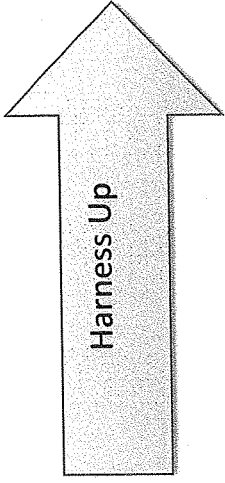

Projected Season

January						
S	M	T	W	T	F	S
				1	2	3
4	5	6	7	8	9	10
11	12	13	14	15	16	17
18	19	20	21	22	23	24
25	26	27	28	29	30	31

February						
S	M	T	W	T	F	S
1	2	3	4	5	6	7
8	9	10	11	12	13	14
15	16	17	18	19	20	21
22	23	24	25	26	27	28

March						
S	M	T	W	T	F	S
1	2	3	4	5	6	7
8	9	10	11	12	13	14
15	16	17	18	19	20	21
22	23	24	25	26	27	28
29	30	31				

April						
S	M	T	W	T	F	S
			1	2	3	4
5	6	7	8	9	10	11
12	13	14	15	16	17	18
19	20	21	22	23	24	25
26	27	28	29	30		

May						
S	M	T	W	T	F	S
					1	2
3	4	5	6	7	8	9
10	11	12	13	14	15	16
17	18	19	20	21	22	23
24	25	26	27	28	29	30
31						

June						
S	M	T	W	T	F	S
	1	2	3	4	5	6
7	8	9	10	11	12	13
14	15	16	17	18	19	20
21	22	23	24	25	26	27
28	29	30				

July						
S	M	T	W	T	F	S
			1	2	3	4
5	6	7	8	9	10	11
12	13	14	15	16	17	18
19	20	21	22	23	24	25
26	27	28	29	30	31	

August						
S	M	T	W	T	F	S
						1
2	3	4	5	6	7	8
9	10	11	12	13	14	15
16	17	18	19	20	21	22
23	24	25	26	27	28	29
30	31					

September						
S	M	T	W	T	F	S
		1	2	3	4	5
6	7	8	9	10	11	12
13	14	15	16	17	18	19
20	21	22	23	24	25	26
27	28	29	30			

October						
S	M	T	W	T	F	S
				1	2	3
4	5	6	7	8	9	10
11	12	13	14	15	16	17
18	19	20	21	22	23	24
25	26	27	28	29	30	31

November						
S	M	T	W	T	F	S
1	2	3	4	5	6	7
8	9	10	11	12	13	14
15	16	17	18	19	20	21
22	23	24	25	26	27	28
29	30					

December						
S	M	T	W	T	F	S
		1	2	3	4	5
6	7	8	9	10	11	12
13	14	15	16	17	18	19
20	21	22	23	24	25	26
27	28	29	30	31		

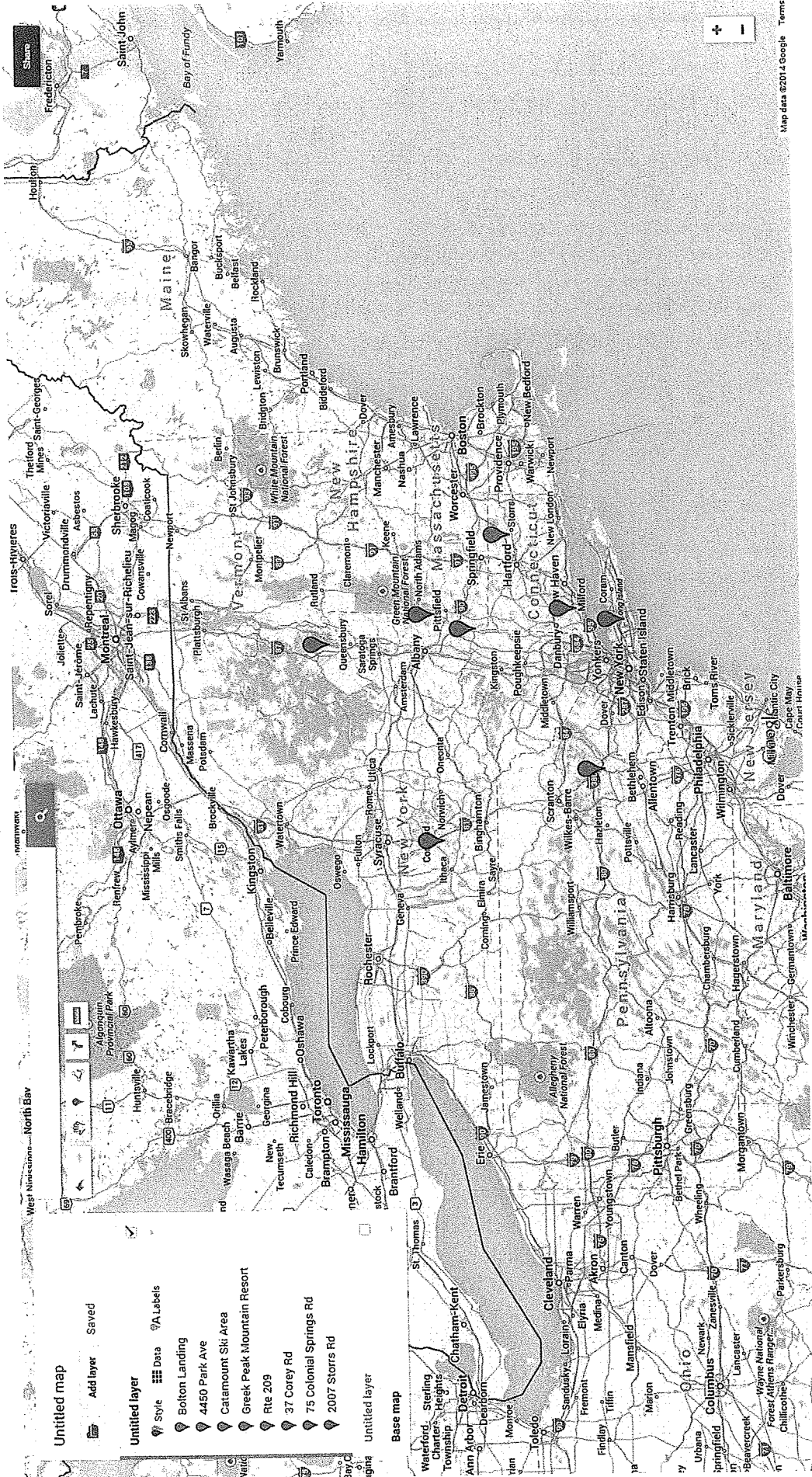

Untitled map

Add layer Saved

Untitled layer

- Style Data Labels
- Bolton Landing
- 4450 Park Ave
- Catamount Ski Area
- Greek Peak Mountain Resort
- Rte 209
- 37 Corey Rd
- 75 Colonial Springs Rd
- 2007 Storrs Rd

Untitled layer

Base map

Scope:

- Signage at the end of the driveway on Lakeside Road
- 20x30 or 20x40 building for ticketing, harnessing, and office
- Starting platform
- Approx. 12 telephone poles installed
- 48 5'x5'/6'x6' platforms on the poles/trees
- 60 elements/obstacles installed

GPS Tracking Solutions



for Municipalities

Management Issues:

Community service

Excessive overtime

Fleet tracking

High fuel costs

Inefficient routing

Insurance risks

Liability protection

Unauthorized vehicle use

Poor vehicle maintenance

Tracking Systems provides:

Asset Management & Tracking

Equipment Tracking

Improved accountability

Improved documentation

Time card verification

Competitive advantage for funding

Driver/passenger protection

Improved routing

Improved vehicle maintenance

Trailer Tracking

"True" leasing



Municipalities have the same issues as the private sector. What makes these issues more difficult is that counties, cities, towns and villages are funded with public dollars. Today, most municipalities are forced to work with reduced state and federal funding while having to maintain the same high levels of service their constituents have come to expect.

Tracking Systems is your answer to these challenges. Our full range of fleet services — including detailed mapping and reporting capabilities — has helped municipalities save thousands of dollars in maintenance costs while providing substantial fuel savings, identifying and eliminating wasted man hours and reducing insurance costs.

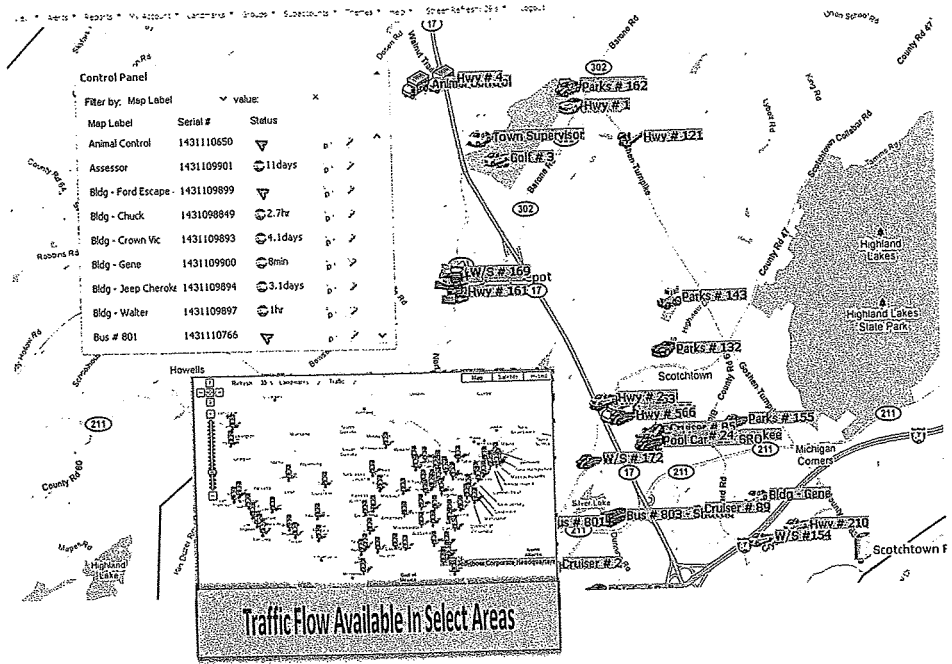

Why Tracking Systems?

- Flexible
- Customizable
- Easy to use
- No software purchase necessary
- Web-based and hosted
- Multiple hardware configuration
- Fleets separated by department
- Highly secure data center
- Local customer support
- Woman-owned enterprise

Tracking Systems... keeping watch over what matters most.

Features

- Services are available from any Internet connection
- Multiple workstations can be connected simultaneously
- Administrator has control over all access parameters and can identify each user with separate login and password
- Information to and from the server is encrypted and secure
- Vehicle route replay for up to 6 months
- Monitors oil changes, registration and maintenance schedules
- Hardware sensors for doors, seats, plows, sanders, sirens, emergency lights, gunlocks, drug cabinets and more

- Alerts from sensor triggers can be transmitted via cell phone and email, and are displayed on dispatch screen for immediate response
- All reports can be saved in Microsoft® Excel for historical comparisons in PDF format or printed

Benefits

- Increased employee efficiency
- Improved emergency response times
- Reduced maintenance costs
- Reduced fuel costs
- Reduced overtime costs
- Potential liability reduction
- Added safety and security
- Enhanced employee accountability
- Reduced paperwork
- Peace of mind



343 Hill Avenue | Montgomery, NY 12549 | 845-738-2200
 www.track-sys.com | sales@track-sys.com



Gil Piaquadio <councilmanpiaquadio@townofnewburgh.org>

council live presentation

2 messages

Robert H Glemming <rglemming@track-sys.com>

Wed, Oct 29, 2014 at 10:45 AM

Reply-To: rglemming@track-sys.com

To: Gil Piaquadio <councilmanpiaquadio@townofnewburgh.org>

Hi Gil,

Have you given any thought on having us present to the entire council? We can do it at your next work shop if you'd like.

Thank you for considering Tracking Systems.

Regards,

Tracking Systems, Inc.

Bob

Robert H. Glemming

Vice President, Marketing and Sales

rglemming@track-sys.com

845-738-2200

914-315-9470

860-546-8551-CT

845-313-2731 Cell

888-335-2162 Fax

Please Visit us at:

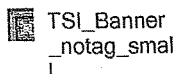

123

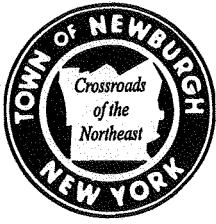

HIGHWAY DEPARTMENT

90 GARDNERTOWN ROAD
NEWBURGH, NEW YORK 12550

TELEPHONE 845-561-2177
FAX 845-561-8987

TODD DEPEW
HIGHWAY SUPERINTENDENT

TO: Gil Piaquadio, Acting Supervisor
FROM: Todd DePew, Highway Superintendent
DATE: November 12, 2014
RE: Transfer Request

I would like to request the following budget transfer could you please put this on the agenda for the next meeting:

FROM:	TO:	AMOUNT:
030.5110.0412	030.5130.0452	\$6,550.00
General Repairs	Machinery	
Street Paving & Resurfacing	Vehicle Contract Repairs	

If you have any questions please feel free to contact me. Thank you.

TD:ch
cc: R. Clum, Accounting
J. Platt, DPW Commissioner

13C



HIGHWAY DEPARTMENT

90 GARDNERTOWN ROAD
NEWBURGH, NEW YORK 12550

TELEPHONE 845-561-2177
FAX 845-561-8987

TODD DEPEW
HIGHWAY SUPERINTENDENT

TO: Gil Piaquadio, Acting Supervisor & Town Board Members
FROM: Todd DePew, Highway Superintendent 
DATE: November 7, 2014
RE: 2 Fisher Sanders

I would like to be put on the agenda, to purchase 2 (two) Fisher 2.5 cu yd. Sanders, 2 (two) stainless steel inverted vee's and 2 (two) strap kits from Hudson River Truck & Trailer for the cost of \$10,560.00 for both.

If you have any questions please feel free to call me. Thanking you in advance.

TD/ch

cc: John Platt, DPW Commissioner

TOWN OF NEWBURGH
SUMMARY OF QUOTATION FORM

11/7/14

REQUESTED BY: Todd DeFews DATE PREPARED: _____
ITEM/SERVICE PURCHASED: 2 - Fisher Polycaster Spreader w/ve's & StrapKits
VENDOR NAME: Automotive Audio Hudson River Truck & Trailer BUKQUIP
ADDRESS: 195 S Plank Rd 12 Commerce St Ext 235 Adams St
CITY/STATE/ZIP: Newburgh NY Poughkeepsie NY Bedford Hills NY
PHONE #: 863-1234 454-7669 914-241-0950

CONTACT PERSON: _____
PRICE QUOTED: \$12,300 \$10,560⁰⁰ \$13,542.00

EXPIRATION DATE: _____
VENDOR CHOSEN: Hudson River Truck & Trailer

*NOTE: If the vendor you wish to purchase from did not give the lowest quote, state reason why you did not purchase from the lowest cost vendor.

DEPARTMENT HEAD SIGNATURE: [Signature] DATE: 11/7/14

(ATTACH WRITTEN QUOTES)

Hudson River Truck and Trailer
 12 Commerce Street Ext.
 Poughkeepsie, NY 12603

Voice: 845-454-7669
 Fax: 845-454-7726

QUOTATION

Quote Number: 28620-WB
 Quote Date: Nov 7, 2014
 Page: 1

Customer:
 Town of Newburgh
 90 Gardnertown Road
 Newburgh, NY 12550

Quote #	Quote Date	Payment Terms	Sales Tax
NEW2177	12/7/14	C.O.D.	

Quantity	Description	Unit Price	Amount
1.00	FISHER POLY-CASTER 8 FT. 2.5 YD ELECTRIC SANDER W/ TIE DOWNS AND "V" INSTALLED ATTN: TODD FAX: 561-8987	5,280.00	5,280.00
Subtotal			5,280.00
Sales Tax			
TOTAL			5,280.00

Burquip
 235 Adams St
 Bedford Hills, NY 10507

QUOTE

Date	Est. #
11/7/2014	13

Page 1 of 1

www.burquip.com burquip@optonline.net

Phone 914 241 0950 Fax 914 666 4790

MON-FRI 8:00-5:00

T/O NEWBURGH HWY

FAX - 845-561-8987

VIN	Good Thru	Vehicle	Sales Rep.

Qty.	Part #	Description	UNIT PRICE	EXTENDED
		FISHER 2.5 POLY CASTER VARIABLE SPEED CONTROL TIE DOWNS		\$6,495.00
	78120	INVERTED V		\$276.00
			Subtotal	\$6,771.00
			Sales Tax	EX
			Total	\$6,771.00

Please provide authorized signature to accept order

We are pleased to submit the above quotation for your consideration.
 Should you place an order, be assured it will receive our prompt attention.
 This quotation is valid for 5 days and does not reflect any unseen increases
 in steel charges. Thereafter it is subject to changes without notice. Deposits
 and special orders are Non-Refundable.

X _____ Date ____/____/____



AUTOMOTIVE AUDIO LTD.

195 S. Plank Rd.
NEWBURGH, NY 12550
(845) 853-1234

CUSTOMER'S ORDER NO.		PHONE	DATE					
		501-277	Oct 23, 14					
NAME								
Town of Newburgh								
ADDRESS								
2 - Fisher Polycaster-Spreaders								
SOLD BY	CASH	C.O.D.	CHARGE	ON ACCT.	ADSE. RET'D.	PAID OUT		
QTY.	DESCRIPTION				PRICE	AMOUNT		
2	Fisher Polycaster				6200	5800 -		
	2.5 @ yd. 6200					5800 -		
2	Twisted vee's				250	500 ⁰⁰ -		
2	Strap kits				100	200 ⁰⁰ -		
						12300 -		
						TAX		
RECEIVED BY						TOTAL	\$12300 -	

C PRODUCT #10

All claims and returned goods must be accompanied by this bill.

Thank You

13D



HIGHWAY DEPARTMENT

90 GARDNERTOWN ROAD
NEWBURGH, NEW YORK 12550

TELEPHONE 845-561-2177
FAX 845-561-8987

TODD DEPEW
HIGHWAY SUPERINTENDENT

TO: Gil Piaquadio, Acting Supervisor & Town Board Members
FROM: Todd DePew, Highway Superintendent
DATE: November 7, 2014
RE: Truck Body & Plows Bid

I would like to be put on the agenda, to go out to bid for a Truck Body & Plows for the Single Axle Class 8 Truck.

If you have any questions please feel free to call me. Thanking you in advance.

TD/ch

cc: John Platt, DPW Commissioner

DRAFT: 7/18/2014 rev. 11/4/2014

INTRODUCTORY LOCAL LAW NO. __ OF 2014

A LOCAL LAW ADDING ARTICLE XVII
ENTITLED
"SOLAR SITING"
TO CHAPTER 185 ENTITLED "ZONING" OF
THE CODE OF THE TOWN OF NEWBURGH

SECTION 1 - TITLE

This Local Law shall be referred to as "A Local Law Adding Article XVII Entitled 'Solar Siting' to Chapter 185 Entitled 'Zoning' of the Code of the Town of Newburgh".

SECTION 2 – SOLAR SITING

A new Article XVII entitled "Solar Siting" is hereby added to Chapter 185 entitled "Zoning" of the Town of Newburgh Municipal Code to read as follows:

"Article XVII: Solar Siting

§185-78 Purpose and Intent.

- A. Solar energy is a renewable and non-polluting energy resource that can prevent fossil fuel emissions and reduce a municipality's energy load. Energy generated from solar energy systems can be used to offset energy demand on the grid where excess solar power is generated.
- B. The use of solar energy equipment for the purpose of providing electricity and energy for heating and/or cooling is a priority and is a necessary component of the Town of Newburgh's current and long-term sustainability agenda.
- C. This Article aims to promote the accommodation of solar energy systems and equipment and the provision for adequate sunlight and convenience of access necessary therefor, and to balance the potential impact on neighbors when solar collectors may be installed near their property while preserving the rights of property owners to install solar energy systems without excess regulation. In particular, this legislation is intended to apply to free standing, ground mounted or pole mounted solar energy system installations based upon certain placement. This legislation is not intended to override agricultural exemptions that are currently in place.

§185-79 Definitions.

As used in this Article, the following terms shall have the meanings indicated, unless the context or subject matter requires otherwise. The definitions contained in Section 185-3 shall also apply.

ALTERNATIVE ENERGY SYSTEMS - Structures, equipment, devices or construction techniques used for the production of heat, light, cooling, electricity or other forms of energy on site and may be attached to or separate from the principal structure.

BUILDING-INTEGRATED PHOTOVOLTAIC (BIPV) SYSTEMS - A solar energy system that consists of integrating photovoltaic modules into the building structure, such as the roof or the façade and which does not alter the relief of the roof.

COLLECTIVE SOLAR - Solar installations owned collectively through subdivision homeowner associations, college student groups, "adopt-a-solar-panel" programs, or other similar arrangements.

~~**EXPEDITED REVIEW** - The grant of a priority status to an application that results in the review of the application ahead of applications filed prior thereto, including applications which may be currently under review by the applicable agency.~~

FLUSH MOUNTED SOLAR PANEL - A photovoltaic panel or tile that is installed flush to the surface of a roof and which cannot be angled or raised.

FREESTANDING OR GROUND-MOUNTED SOLAR ENERGY SYSTEM - A solar energy system that is directly installed in the ground and is not attached or affixed to an existing structure. Pole mounted solar energy systems shall be considered Freestanding or Ground-Mounted Solar Energy Systems for purposes of this Local Law.

NET-METERING - A billing arrangement that allows solar customers to get credit for excess electricity that they generate and deliver back to the grid so that they only pay for their net electricity usage at the end of the month.

PERMIT GRANTING AUTHORITY - The Town Code Compliance Department, which is charged with granting permits for the operation of solar energy systems.

PHOTOVOLTAIC (PV) SYSTEMS - A solar energy system that produces electricity by the use of semiconductor devices, called photovoltaic cells that generate electricity whenever light strikes them.

QUALIFIED SOLAR INSTALLER - A person who has skills and knowledge related to the construction and operation of solar electrical equipment and installations and has received safety training on the hazards involved. Persons who are on the list of eligible photovoltaic installers maintained by the New York State Energy Research

and Development Authority (NYSERDA), or who are certified as a solar installer by the North American Board of Certified Energy Practitioners (NABCEP), shall be deemed to be qualified solar installers for the purposes of this definition. Persons who are not on NYSERDA's list of eligible installers or NABCEP's list of certified installers may be deemed to be qualified solar installers if the Town Code Compliance Supervisor or such other Town officer or employee as the Town Board designates determines such persons have had adequate training to determine the degree and extent of the hazard and the personal protective equipment and job planning necessary to perform the installation safely. Such training shall include the proper use of special precautionary techniques and personal protective equipment, as well as the skills and techniques necessary to distinguish exposed energized parts from other parts of electrical equipment and to determine the nominal voltage of exposed live parts.

ROOFTOP OR BUILDING MOUNTED SOLAR SYSTEM - A solar power system in which solar panels are mounted on top of the structure of a roof either as a flush-mounted system or as modules fixed to frames which can be tilted toward the south at an optimal angle.

SETBACK - The distance from a front lot line, side lot line or rear lot line of a parcel within which a free standing or ground mounted solar energy system is installed.

SMALL-SCALE SOLAR - For purposes of this Chapter, the term "small-scale solar" refers to solar photovoltaic systems that produce up to ten kilowatts (kW) per hour of energy or solar-thermal systems which serve the building to which they are attached, and do not provide energy for any other buildings.

SOLAR ACCESS - Space open to the sun and clear of overhangs or shade including the orientation of streets and lots to the sun so as to permit the use of active and/or passive solar energy systems on individual properties.

SOLAR COLLECTOR - A solar photovoltaic cell, panel, or array, or solar hot air or water collector device, which relies upon solar radiation as an energy source for the generation of electricity or transfer of stored heat.

SOLAR EASEMENT - An easement recorded pursuant to NY Real Property Law § 335-b, the purpose of which is to secure the right to receive sunlight across real property of another for continued access to sunlight necessary to operate a solar collector.

SOLAR ENERGY EQUIPMENT/SYSTEM - Solar collectors, controls, energy storage devices, heat pumps, heat exchangers, and other materials, hardware or equipment necessary to the process by which solar radiation is collected, converted into another form of energy, stored, protected from unnecessary dissipation and distributed. Solar systems include solar thermal, photovoltaic and concentrated solar. For the purposes of this law, a solar energy system does not include any solar energy system of four square feet in size or less.

SOLAR FARM OR SOLAR POWER PLANT – Energy generation facility or area of land principally used to convert solar energy to electricity, whether by photovoltaics, concentrating solar thermal devices or various experimental solar technologies, with the primary purpose of wholesale or retail sales of electricity.

SOLAR PANEL - A device for the direct conversion of solar energy into electricity.

~~SOLAR POWER FAST TRACK PROGRAM - A program to expedite all applications for commercial and residential solar panel installation to encourage the use of reliable and clean renewable energy.~~

SOLAR STORAGE BATTERY - A device that stores energy from the sun and makes it available in an electrical form.

SOLAR-THERMAL SYSTEMS - Solar thermal systems directly heat water or other liquid using sunlight. The heated liquid is used for such purposes as space heating and cooling, domestic hot water, and heating pool water.

§185-80 Applicability.

- A. The requirements of this local law shall apply to all solar energy system and equipment installations modified or installed after the effective date of this local law.
- B. Solar energy system installations for which a valid building permit has been issued or, if no building permit is presently required, for which installation has commenced before the effective date of this local law shall not be required to meet the requirements of this local law.
- C. All solar energy systems shall be designed, erected and installed in accordance with all applicable codes, regulations and industry standards as referenced in the State Building Code and the Town Code.
- D. Solar collectors, unless part of a Solar Farm or Solar Power Plant, shall be permitted only to provide power for use by owners, lessees, tenants, residents, or other occupants of the premises on which they are erected, but nothing contained in this provision shall be construed to prohibit “collective solar” installations or the sale of excess power through a “net billing” or “net-metering” arrangement in accordance with New York Public Service Law § 66-j or similar state or federal statute.

§185-81 Permit required.

- A. No Small Scale solar energy system or device shall be installed or operated in the Town except in compliance with this article.
- B. Rooftop and Building-Mounted Solar Collectors: Rooftop and building mounted solar collectors are permitted in all zoning districts in the Town subject to the following conditions:
- 1 Building permits shall be required for installation of all rooftop and building-mounted solar collectors, except a building permit shall not be required for Flush-Mounted Photovoltaic Panels.
 - 2 Rooftop and Building-Mounted Solar Collectors Building shall not ~~any~~ exceed the maximum allowed height of the principal use in any zoning district.
 - 3 In order to ensure firefighter and other emergency responder safety, except in the case of accessory buildings under 1,000 square feet in area, there shall be a minimum perimeter area around the edge of the roof and structurally supported pathways to provide space on the roof for walking around all Rooftop and Building-Mounted Solar Collectors. Additionally, installations shall provide for adequate access and spacing in order to:
 - i. Ensure access to the roof
 - ii. Provide pathways to specific areas of the roof
 - iii. provide for smoke ventilation opportunity areas
 - iv. provide emergency egress from the roof.

Formatted: Font: Not Italic, Font color: Auto

Exceptions to these requirements may be requested where access, pathway or ventilation requirements are reduced due to:

- i. Unique site specific limitations;
- ii. alternative access opportunities (as from adjoining roofs)
- iii. ground level access to the roof area in question;
- iii. other adequate ventilation opportunities when approved by the Code Compliance Department;
- iv. adequate ventilation opportunities afforded by panel set back from other rooftop equipment (for example: shading or structural constraints may leave significant areas open for ventilation near HVAC equipment.);
- v. automatic ventilation device; or
- vi. New technology, methods, or other innovations that ensure adequate emergency responder access, pathways and ventilation opportunities.

Formatted: Indent: Left: 1"

In the event any of the standards in this subsection B(3) are more stringent than the New York State Uniform Fire Prevention and Building Code (the "State Code"), they shall be deemed to be installation guidelines only and the standards of the State Code shall apply.

C. Building-Integrated Photovoltaic (BIPV) Systems: BIPV systems are permitted in all zoning districts and shall be shown on the plans submitted for the building permit application for the building containing the system.

D. ~~Ground Mounted and Free Standing and ground mounted Solar Collectors:~~
~~Ground mounted and free standing or ground mounted solar collectors~~ are permitted as accessory structures in all zoning districts of the Town except the R-3 District subject to the following conditions:

1. Building permits are required for the installation of all ground-mounted and free standing solar collectors.

2. In the R-2 District, a lot must have a minimum size of 40,000 square feet in order for a ground-mounted or free standing solar collector to be permitted

3. The location of the ground mounted or free standing solar collector shall meet the greater of the setback requirements for Accessory Buildings set forth in Section 185-15 or the following setback requirements and limitations set forth in this provision:

i. RR District

- minimum required side yard setback- 50 feet
- minimum required rear yard setback- 100 feet
- minimum required front yard setback- 250 feet

ii. AR District

- minimum required side yard setback- 30 feet
- minimum required rear yard setback- 50 feet
- minimum required front yard setback- 250 feet

iii. R-1 District

- minimum required side yard setback- 30 feet
- minimum required rear yard setback- 40 feet
- no ground mounted or free standing solar collectors allowed in front yard

iv. R-2 District

- minimum required side yard setback- 30 feet
- minimum required rear yard setback- 40 feet
- no ground mounted or free standing solar collectors allowed in front yard

v. R-3 District

Formatted: Font: Bold
Formatted: Indent: Left: 0.63", No bullets or numbering
Formatted: Numbered + Level: 1 + Numbering Style: 1, 2, 3, ... + Start at: 1 + Alignment: Left + Aligned at: 0.63" + Indent at: 0.88"
Formatted: Indent: Left: 0.88", First line: 0"

Ground-mounted and free standing solar collectors are not permitted in the R-3 District in connection with ANY USE

Formatted: Font: 16 pt
Formatted: Font: Italic

- ~~• minimum required side yard setback- 30 feet~~
- ~~• minimum required rear yard setback- 40 feet~~
- ~~• no ground mounted or free standing solar collectors allowed in front yard~~

vi. B District

- minimum required side yard setback- 1530 feet
- minimum required rear yard setback- 50 feet
- no ground mounted or free standing solar collectors allowed in front yard

vii. IB District

- minimum required side yard setback- 1530 feet
- minimum required rear yard setback- 40 feet
- minimum required front yard setback- 250 feet

viii. I District

- minimum required side yard setback- 30 feet
- minimum required rear yard setback- 40 feet
- minimum required front yard setback- 250 feet

Yards having a line bounding on the right of way of Interstate 87 or Interstate Route 84 shall not be considered front yards for purposes of this Section.

~~2-4.~~ The height of the solar collector and any mounts shall not exceed 20 feet when oriented at maximum tilt.

Formatted: Indent: Left: 0.63", No bullets or numbering

~~3-5.~~ Ground mounted and freestanding solar collectors shall be screened when possible and practicable from adjoining lots and street rights of way through the use of architectural features, earth berms, landscaping, fencing or other screening which will harmonize with the character of the property and surrounding area.

Formatted: Indent: Left: 0.63", No bullets or numbering

~~4-6.~~ Solar energy equipment shall be located in a manner to reasonably minimize view blockage for surrounding properties and shading of property to the north, while still providing adequate solar access for collectors.

Formatted: Indent: Left: 0.63", No bullets or numbering

~~5-7.~~ Solar energy equipment shall not be sited within any required buffer area.

Formatted: Indent: Left: 0.63", No bullets or numbering

~~6-8.~~ The total surface area of all ground-mounted and freestanding solar collectors on a lot shall not exceed _____ square feet the area of the ground covered by the

Formatted: Indent: Left: 0.63", No bullets or numbering

building structure of the largest building on the lot measured from the exterior walls, excluding patios, decks, balconies, screened and open porches and attached garages, provided that non-residential placements exceeding this size may be approved by the Planning Board, subject to site plan review pursuant to Article IX of this Chapter /Zoning Board of Appeals, and a determination such placement will still constitute an accessory use.

7-9- The area beneath ground mounted and freestanding solar collectors shall be included in calculating whether the lot meets maximum permitted Lot Building Coverage and Lot Surface Coverage requirements for the applicable District, notwithstanding that the collectors are not "buildings."

Formatted: Indent: Left: 0.63", No bullets or numbering

8-10. The installation of ground mounted and freestanding solar collectors shall be considered a Development or Development Activity for purposes of Chapter 157, Stormwater Management, of the Code of the Town of Newburgh.

Formatted: Indent: Left: 0.63", No bullets or numbering

- E. Solar-Thermal Systems: Solar-thermal systems are permitted in all zoning districts subject to the following condition:
1. Building permits are required for the installation of all solar-thermal systems.
 2. Ground mounted and free standing solar-thermal systems shall be subject to the same requirements set forth in Subsection D above as for Ground Mounted and Free Standing Solar Collectors.
- F. Solar energy systems and equipment shall be permitted only if they are determined by the Town not to present any unreasonable safety risks, including, but not limited to, the following:
1. Weight load
 2. Wind resistance
 3. Ingress or egress in the event of fire or other emergency.
- G. Solar collectors and related equipment shall be surfaced, designed and sited so as not to reflect glare onto adjacent properties and roadways.

§185-82. Safety.

A. All solar collector installations must be performed by a qualified solar installer.

- B. Prior to operation, electrical connections must be inspected by a Town Code Enforcement Officer and by an appropriate electrical inspection person or agency, as determined by the Town.
- C. Any connection to the public utility grid must be inspected by the appropriate public utility.
- D. Solar energy systems shall be maintained in good working order.
- E. Rooftop and building-mounted solar collectors shall meet New York's Uniform Fire Prevention and Building Code standards.
- F. If solar storage batteries are included as part of the solar collector system, they must be placed in a secure container or enclosure meeting the requirements of the New York State Building Code when in use and when no longer used shall be disposed of in accordance with the laws and regulations of the Town and other applicable laws and regulations.
- G. If a solar collector ceases to perform its originally intended function for more than 12 consecutive months, the property owner shall remove the collector, mount and associated equipment by no later than 90 days after the end of the twelve-month period.
- H. Solar Energy Systems and Equipment shall be marked in order to provide emergency responders with appropriate warning and guidance with respect to isolating the solar electric system. Materials used for marking shall be weather resistant. For residential applications, the marking may be placed within the main service disconnect. If the main service disconnect is operable with the service panel closed, then the marking should be placed on the outside cover.
For commercial application, the marking shall be placed adjacent to the main service disconnect in a location clearly visible from the location where the lever is operated.

§185-83 Solar Farms and Solar Power Plants.

Solar Farms and Solar Power Plants shall be permitted in the I District as an "Electric Generating" use subject to site plan review by the Planning Board, subject to the following supplementary regulations:

- A. Solar farms and solar power plants shall be enclosed by perimeter fencing to restrict unauthorized access at a height of 8 ½ feet.
- B. The manufacturer's or installer's identification and appropriate warning signage shall be posted at the site and clearly visible.

~~*[Optional add-on: Solar Panel Fast Track Program]*~~

~~*I. This section applies to the installation of solar panels for commercial buildings and residences.*~~

~~*J. All building permit application fees for the construction and installation of solar panels on residential and non-residential buildings shall be waived.*~~

~~*K. All building permit applications for the installation of solar panels on residential and non-residential buildings shall receive expedited review by the Code Compliance Department in order to expedite such applications and the issuance of building permits for solar panel installation.*~~

Formatted: Indent: Left: 0"
Formatted: No bullets or numbering
Formatted: Indent: Left: 0"
Formatted: No bullets or numbering
Formatted: Indent: Left: 0"
Formatted: No bullets or numbering

Optional add-on: Guidelines for Future Solar Access

I. New structures will be sited to take advantage of solar access insofar as practical, including the orientation of proposed buildings with respect to sun angles, the shading and windscreen potential of existing and proposed vegetation on and off the site, and the impact of solar access to adjacent uses and properties.¹

M. J. To permit maximum solar access to proposed lots and future buildings, wherever reasonably feasible, consistent with other appropriate design considerations and to the extent practicable, new streets shall be located on an east-west axis to encourage building siting with the maximum exposure of roof and wall area to the sun. The Planning Board shall also consider the slope of the property and the nature and location of existing vegetation as they affect solar access.²

N. K. The impact of street trees on the solar access of the surrounding property shall be minimized to the greatest possible extent in selecting and locating shade trees. Every effort shall be made to avoid shading possible locations of solar collectors.

O. L. When the Planning Board reviews and acts upon applications for subdivision approval or site plan approval, it shall take into consideration whether the proposed construction would block access to sunlight between the hours of [9:00 a.m. and 3:00 p.m.] Eastern Standard Time for existing approved solar energy collectors or for solar energy collectors for which a permit has been issued.

P.A. The Planning Board may require subdivisions to be platted so as to preserve or enhance solar access for either passive or active systems, consistent with the other requirements of the Town Code.

P.N. The plan for development of any site within cluster subdivisions shall be designed and arranged in such a way as to promote solar access for all dwelling units. Considerations may include the following:

- 1. In order to maximize solar access, the higher-density dwelling units should be placed on a south-facing slope and lower-density dwelling units sited on a north-facing slope.*
- 2. Subject to the Town's] setback requirements, structures should be sited as close to the north lot line as possible to increase yard space to the south for reduced shading of the south face of a structure.*
- 3. A tall structure should be sited to the north of a short structure.]*

§185-86 Penalties for offenses.

Section 185-52 of the Zoning Code applies to violations of this Article.”

SECTION 3 - SEVERABILITY

If any word, phrase, sentence, part, section, subsection, or other portion of this Law or any application thereof to any person or circumstance is declared void, unconstitutional, or invalid for any reason, then such word, phrase, sentence, part, section, subsection, or other portion, or the proscribed application thereof, shall be severable, and the remaining provisions of this Law, and all applications thereof, not having been declared void, unconstitutional, or invalid, shall remain in full force and effect.

SECTION 4 - CONFLICT WITH OTHER LAWS

Where this Law differs or conflicts with other Laws, rules and regulations, unless the right to do so is preempted or prohibited by the County, State or Federal government, the more restrictive or protective of the Town and the public shall apply.

SECTION 5 - EFFECTIVE DATE.

This Law shall become effective upon filing with the New York State Secretary of State.

SECTION 6 - AUTHORITY.

This Local Law is enacted pursuant to the Municipal Home Rule Law. This Local Law shall supersede the provisions of Town Law to the extent it is inconsistent with the same, and to the extent permitted by the New York State Constitution, the Municipal Home Rule Law, or any other applicable statute.

15

November 12th Audit Meeting

Purchase of one (1) Desktop Computer for a cost of \$ 900.00 to be used at the New DAT location

From Account _____



FID Number: 74-2616805
 Sales Rep: RACHEL CHRISTMAN
 For Sales: (800)981-3355
 Sales Fax: (800)433-9527
 For Customer Service: (800)981-3355
 For Technical Support: (800)822-8965
 Dell Online: <http://www.dell.com>

Customer Number: 000459815
 Purchase Order: G20140328
 Order Number: 590906612
 Order Date: 03/28/14
 83 01 O 01 01 N

Invoice Number: **XJD1TCKK3**

Invoice Date: 04/01/14
 Payment Terms: NET DUE 30 DAYS
 Due Date: 05/01/14
 Shipped Via: FEDEX GROUND
 Waybill Number: 918193487130763

SOLD TO:
 #BWNHKPV
 #0004 598157#
 GIL PIAQUADIO
 TOWN OF NEWBURGH
 1496 ROUTE 300
 NEWBURGH, NY 12550-2677

SHIP TO:
 GIL PIAQUADIO
 TOWN OF NEWBURGH
 1496 ROUTE 300
 NEWBURGH, NY 12550-2677

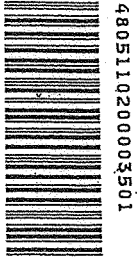

PLEASE REVIEW IMPORTANT TERMS & CONDITIONS ON THE REVERSE SIDE OF THIS INVOICE

Order	Shipped	Item Number	Description	Unit	Unit Price	Amount
1	1	210-AATM	OptiPlex 9020 Mini Tower	EA	642.31	642.31
1	1	370-AAME	4GB (1x4GB) 1600MHz DDR3 Non-E CC	EA	-	-
1	1	580-AAQX	US English (QWERTY) Dell KB212 -B QuietKey USB Keyboard Black	EA	-	-
1	1	480-ABHJ	No Monitor	EA	-	-
1	1	490-BBIK	AMD RadeonHD 8490, 1GB DDR3, F H, 1 DP 1 DVI, Dell OptiPlex	EA	-	-
1	1	555-BBFO	No Wireless	EA	-	-
1	1	400-AANQ	320GB 2.5inch Serial ATA (7.20 0 Rpm) Hard Drive	EA	-	-
1	1	470-AAED	Cable, SATA, 280MM, Black	EA	-	-
1	1	575-BBBR	Bracket for 2.5inch HDD, OptiPlex	EA	-	-
1	1	470-AAEF	Cable for SATA HDD, OptiPlex	EA	-	-
1	1	340-ADBJ	Thank You for Choosing Dell	EA	-	-
1	1	421-5606	Windows 7 Professional, No Media, 64-bit, OptiPlex, English	EA	-	-
1	1	570-AAACR	Dell USB Optical Mouse MS111	EA	-	-
1	1	555-BBKH	No Bcom required	EA	-	-
1	1	429-AAED	16X Half Height DVD+/-RW Drive	EA	-	-
1	1	520-AABP	Internal Dell Business Audio Speaker	EA	-	-
1	1	555-BBFO	No Wireless	EA	-	-
1	1	450-AAOJ	System Power Cord (Philippine/T H/US)	EA	-	-
1	1	340-ABSZ	Safety/Environment and Regulatory Guide (English)	EA	-	-
1	1	696-BBBC	No Bios Required	EA	-	-
1	1	630-AABE	Microsoft Office Home and Business 2013, OptiPlex, Precision Latitude	EA	-	-
1	1	933-8134	*Basic Hardware Service: Next Business Day Onsite Service After Remote Diagnosis 4 Year Extended	EA	-	-
1	1	939-2491	*Basic Hardware Service: Next Business Day Onsite Service After Remote Diagnosis Initial Year	EA	-	-
1	1	939-1018	*Dell Limited Hardware Warranty Plus Service Extended Year(s)	EA	-	-
1	1	935-6167	*Dell Limited Hardware Warranty Plus Service Initial Year	EA	-	-

Ship. &/or Handling	\$	0.00
Subtotal	\$	860.31
Taxable:	Tax:	
\$ 0.00	\$	0.00
ENVIRO FEE	\$	0.00
Invoice Total	\$	860.31

FOR SHIPMENTS TO CALIFORNIA, A STATE ENVIRONMENTAL FEE OF UP TO \$5 PER ITEM WILL BE ADDED TO INVOICES FOR ALL ORDERS CONTAINING A DISPLAY GREATER THAN 4 INCHES. PLEASE KEEP ORIGINAL BOX FOR ALL RETURNS. COMPREHENSIVE, ONLINE CUSTOMER CARE INFORMATION AND ASSISTANCE IS A CLICK AWAY AT WWW.DELL.COM/PUBLIC-ECARE TO ANSWER A VARIETY OF QUESTIONS REGARDING YOUR DELL ORDER.



DETACH AT PERFORM AND RETURN WITH PAYMENT

MAKE CHECK PAYABLE/REMIT TO:

DELL MARKETING L.P.
 C/O DELL USA L.P.
 PO BOX 643561
 PITTSBURGH, PA 15264-3561

Invoice Number: XJD1TCKK3
 Customer Name: TOWN OF NEWBURGH
 Customer Number: 000459815
 Purchase Order: G20140328
 Order Number: 590906612

Ship. &/or Handling	\$	0.00
Subtotal	\$	860.31
Taxable:	Tax:	
\$ 0.00	\$	0.00
ENVIRO FEE	\$	0.00
Invoice Total	\$	860.31
	\$	
	\$	
	\$	
Balance Due	\$	860.31
Amt. Enclosed	\$	

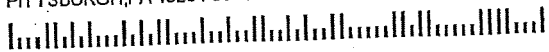



FID Number: 74-2616805
 Sales Rep: RACHEL CHRISTMAN
 For Sales: (800)981-3355
 Sales Fax: (800)433-9527
 For Customer Service: (800)981-3355
 For Technical Support: (800)822-8965
 Dell Online: <http://www.dell.com>

Customer Number: 000459815
 Purchase Order: G20140328
 Order Number: 590906612
 Order Date: 03/28/14

Invoice Number: **XJD1TCKK3**

Invoice Date: 04/01/14
 Payment Terms: NET DUE 30 DAYS
 Due Date: 05/01/14
 Shipped Via: FEDEX GROUND
 Waybill Number: 918193487130763

83 01 0 01 01 N

SOLD TO:

GIL PIAQUADIO
 TOWN OF NEWBURGH
 1496 ROUTE 300
 NEWBURGH, NY 12550-2677

SHIP TO:

GIL PIAQUADIO
 TOWN OF NEWBURGH
 1496 ROUTE 300
 NEWBURGH, NY 12550-2677

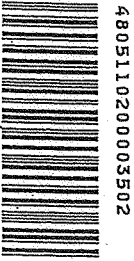

PLEASE REVIEW IMPORTANT TERMS & CONDITIONS ON THE REVERSE SIDE OF THIS INVOICE

Order	Shipped	Item Number	Description	Unit	Unit Price	Amount
1	1	631-AABI	Intel vPro Technology Enabled	EA	12.00	12.00
1	1	340-ABJK	Resource DVD contains Diagnost ics and Drivers, 9020	EA	3.00	3.00
1	1	340-ACJI	Englis Setup and Features Guid e	EA	-	-
1	1	429-AAHB	No Internal Optical Drive	EA	-	-
1	1	470-AAIO	DisplayPort-DVI Adapter	EA	15.00	15.00
1	1	332-1286	Non-Canada Orders only	EA	-	-
1	1	329-BBIE	OptiPlex 9020 MT up to 90% eff icient PSU Base Mini Tower Cha ssis	EA	-	-
1	1	387-BBDC	Dell Energy Star 5.2 - D	EA	-	-
1	1	338-BCCE	Intel Core i5-4570 Processor (Quad Core, 6MB Cache, 3.2GHz, w/HD Graphics 4600)	EA	182.00	182.00
1	1	954-3465	*No DDPE Encryption Software	EA	-	-
1	1	461-AAAZ	Chassis Intrusion Switch	EA	3.00	3.00
1	1	551-BBBJ	NO INTEL RESPONSIVE	EA	-	-
1	1	412-AAAV	Minitower Chassis Mainstream H eatsink (95watts)	EA	-	-
1	1	340-ABVE	Shipping Material for System,M initower,Dell OptiPlex	EA	-	-
1	1	429-AAGQ	PowerDVD Software not included	EA	-	-
1	1	340-ADBJ	Thank You for Choosing Dell	EA	-	-
1	1	340-ADBJ	Thank You for Choosing Dell	EA	-	-
1	1	389-BCCV	Regulatory Label	EA	-	-
1	1	382-BBBZ	No Add On Card	EA	-	-
1	1	389-BBWQ	Intel Core i5 vPro Label	EA	-	-
1	1	389-BCCZ	Windows 7 Label, OptiPlex, Fix ed Precision, Vostro Desktop	EA	-	-
1	1	421-9982	Thank you for buying Dell	EA	-	-
1	1	422-0008	Dell Data Protection System To ols Digital Delivery/DT	EA	-	-
1	1	421-4047	Dell Digital Delivery Client	EA	-	-
1	1	632-BBBZ	Visit www.dell.com/encryption	EA	-	-
1	1	632-BBCB	Thank you for buying Dell	EA	-	-
1	1	658-BBNH	Waves Maxx Audio	EA	-	-
1	1	658-BBMQ	Enable Low Power Mode	EA	-	-
1	1	658-BBMT	Dell Client System	EA	-	-
1	1	640-BBDF	Adobe Reader 11	EA	-	-
1	1	640-BBEV	Dell Data Protection Protect ed Workspace	EA	-	-
1	1	817-BBBN	NO RAID	EA	-	-
1	1	650-AAHJ	No Anti-Virus software	EA	-	-
1	1	620-AALT	Windows 7 Professional 64bit M edia Kit (Multiple Language)	EA	3.00	3.00
1	1	637-AAAK	Dell Back-up and Recovery Mana ger for Windows 7, Multiple La nguage POET #P566020186NO STIMULUS FUNDING83AEA PT65340 System Service Tags 4C19K02	EA	-	-



TOWN OF NEWBURGH POLICE DEPARTMENT

300 Gardnertown Road, Newburgh, New York 12550

Michael P. Clancy
Chief of Police

(845) 564-1100

Date: 11/07/14

To: Town Board Members

From: Chief Michael Clancy

Subject: Fund Transfer

Dear Acting Town Supervisor:

To cover the cost of HCC claim # NY6170856 I request that the following be transferred:
\$1,000.00 from account # 3030.466, \$10,000 from account # 3010.497, \$6,000 from
account # 3020.455 and \$3,219.42 from account # 3120.100 to account # 001-1910-0499.
Thank you for your consideration on this matter.

Respectfully Submitted:

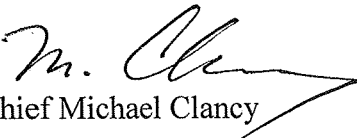
Chief Michael Clancy

17

TOWN OF NEWBURGH

1496 Route 300
Newburgh, New York 12550
(845) 564-4552

DO NOT WRITE IN THIS BOX

DEPARTMENT _____

CLAIMANT'S
NAME
AND
ADDRESS

HCC

TERMS Net 30 Days

Date Voucher Received		VOUCHER NO.
FUND - APPROPRIATION	AMOUNT	
Total		
Abstract #		

Invoice # _____

Dates	Quantity	Description of Materials or Services	Unit Price	Amount
		RE: Claim # NY 170856 "Town driver failed to yield right of way and struck claimant (school bus)." Date of incident: 8/11/14		
TOTAL				20,219.42

CLAIMANT'S CERTIFICATION

Starmania Barnes certify that the above account in the amount of \$ _____ is true and correct; that the items, services and disbursements charged were rendered to or for the municipality on the dates stated; that no part has been paid or satisfied; that taxes, from which the municipality is exempt, are not included; and that the amount claimed is actually due.

10/21/14
DATE

Starmania Barnes
SIGNATURE

Claims Adjuster
TITLE

(Space below for municipal use)

DEPARTMENT APPROVAL

The above services or materials were rendered or furnished to the municipality on the dates stated and the charges are correct.

Date _____

Authorized Official _____

APPROVAL FOR PAYMENT

This claim is approved and ordered for paid from the appropriations indicated above

Date _____

Auditing Board _____



HCC

HCC Public Risk Claim Service, Inc.
1700 Opdyke Court, Auburn Hills, Michigan 48326
main 800 225 6561 facsimile 248 371 3091

October 21, 2014

Attn: Cindy Wartinez
Town of Newburgh
1496 Route 300
Newburgh, NY 12550

Program: HCC Public Risk
Our Insured: Town of Newburgh
Date of Loss: 8/11/2014
Our Claim #: NY6 170856
Claimant: First Student, Inc.

Dear Ms. Wartinez:

We handle the claims for the HCC Public Risk through which the Town of Newburgh is insured. We have completed our investigation and handling of the above-stated claim in which the Town employee operating a police vehicle when he struck the claimant's vehicle.

We have issued a check to the claimant in the amount of \$20,219.42. This represents the amount of money that we paid for the claimant's vehicle. The Town's auto liability deductible is \$25,000.00.

Please issue a check payable to "HCC Public Risk Claim Service, Inc." in the amount of \$20,219.42 for the Town's deductible.

If you have any questions, please do not hesitate to call me.

Sincerely,

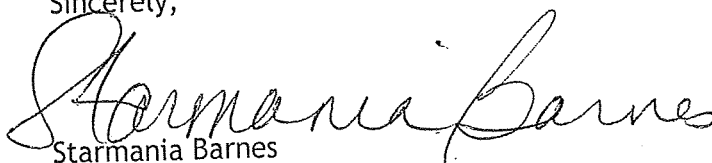
Starmania Barnes
Claims Adjuster II

CC: Corieri & Associate, Inc. (601)

INVOICE

Date: October 21, 2014

Attn: Carly Williams
Town of Newburgh
1496 Route 300
Newburgh, NY 12550

Claim #: NY6 170856

Department:

Terms: Due up receipt

Insured: Town of Newburgh

Policy # CPKG80620021

Date of Loss 8/11/2014

Claimant: First Student Inc.

Service:

Drive Time

Automobile \$25,000.00 (liability deductible)

Photographs

Office Expense

Other Expense-
Deductible

Subtotal \$20,219.42

Sales Tax (0%)

Invoice Total \$20,219.42

Please Remit to: HCC Public Risk Claim Service, Inc.
1700 Opdyke Court
Auburn Hills, MI 48326

Please make check payable to HCC Public Risk Claim Service, Inc. and reference claim number on all correspondence. Thanks.

RELEASE OF PROPERTY DAMAGE CLAIM

KNOW ALL BY THESE PRESENTS, That the Undersigned, First Group America a/s/o First Student, Inc., being of lawful age, in consideration of the payment by HCC Public Risk Claim Service, Inc., HCC Public Risk, and U.S. Specialty Insurance Company the sum of Twenty Thousand Two Hundred Nineteen and 42/100 Dollars (\$20,219.42) to be paid to First Group America a/s/o First Student, Inc. on behalf of the Town of Newburgh the receipt where of is hereby acknowledged, has released and discharged, and by these presents does hereby forever release and discharge, the Town of Newburgh, its directors, officers, employees, adjusters, managers, agents, attorneys, successors, affiliated companies, and assigns, for and from any and all property damage claims, demands, controversies, damages, and particularly on account of all property damage claims arising, known or unknown, which may have resulted from an incident which occurred on or about August 11, 2014.

It is understood and agreed that the consideration paid by HCC Public Risk Claim Service, Inc., HCC Public Risk, and U.S. Specialty Insurance Company is not to be construed as an admission of any liability but that the payment is being made in compromise and settlement of claims that are in dispute.

First Group America a/s/o First Student, Inc. acknowledges that this release contains the entire agreement between the parties and that that it is not relying upon any representation of HCC Public Risk Claim Service, Inc., HCC Public Risk, and U.S. Specialty Insurance Company beyond the amount of consideration to be paid in return for the release's execution.

By signing below, the undersigned warrants that he or she has the authority to bind themselves to the terms of this release.

THE UNDERSIGNED HAS READ THE FOREGOING RELEASE AND FULLY UNDERSTANDS IT.

SIGNED, SEALED AND READ THIS 20th DAY OF October, 2014, IN THE PRESENCE OF:

CAUTION: READ BEFORE SIGNING BELOW ↓

Elizabeth M. Dagon
Witness
Anna Cook
Witness

Glenn Degen Heller Sebastian Adjuster
First Group America a/s/o First Student, Inc.

STATE OF Texas)
COUNTY OF Tarrant)

On the 20th day of October, 2014, before me personally appeared

First Group America a/s/o First Student, Inc. to me known to be the person(s) named herein and executed the foregoing Release and acknowledged to me that First Group America a/s/o First Student, Inc. voluntarily executed the same.

My term expires June 20, 2017

Helena Campbell
Notary Public

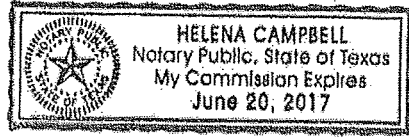

New York State Department of Motor Vehicles
POLICE ACCIDENT REPORT

MV-104A (6/04)

Local Codes
5811993
SPM2123CXJWK

AMENDED REPORT

1 Accident Date: Month 8, Day 11, Year 2014, Day of Week Monday, Military Time 15:40, No. of Vehicles 2, No. Injured 2, No. Killed 0, Not Investigated at Scene , Left Scene , Police Photos Yes No, Accident Reconstructed

2 VEHICLE 1: VEHICLE 2: BICYCLIST PEDESTRIAN OTHER PEDESTRIAN

3 VEHICLE 1 - Driver License ID Number 843211128, State of Lic. NY, Driver Name - exactly as printed on license KARABELAS, TASO, Address (include Number and Street) 300 GARDNERTOWN ROAD, Apt. No. [blank]

3 VEHICLE 2 - Driver License ID Number 501811255, State of Lic. NY, Driver Name - exactly as printed on license SMITH, CHARLES, Address (include Number and Street) PO BOX 85, Apt. No. [blank]

3 Date of Birth: Month 2, Day 21, Year 1980, Sex M, Unlicensed , No. of Occupants 01, Public Property Damaged ; Date of Birth: Month 3, Day 21, Year 1973, Sex M, Unlicensed , No. of Occupants 04, Public Property Damaged

4 Name - exactly as printed on registration: C, Date of Birth: [blank], Sex C, Name - exactly as printed on registration: FIRST STUDENT INC., Sex C, Date of Birth: [blank]

4 Address (include Number and Street): 1496 STATE ROUTE 300, Apt. No. [blank], State NY, Zip Code 12550; Address (include Number and Street): PO BOX 346, Apt. No. [blank], State NY, Zip Code 12589

5 City or Town: NEWBURGH, State NY, Zip Code 12550; City or Town: WALLKILL, State NY, Zip Code 12589

6 Plate Number: POLICE, State of Reg. NY, Vehicle Year & Make: 2013 FORD, Vehicle Type: POLI, Ins. Code: 716; Plate Number: 23153BB, State of Reg. NY, Vehicle Year & Make: 2014 THMS, Vehicle Type: BUS, Ins. Code: 228

7 Violation Section(s): [blank]; Violation Section(s): [blank]

7 Check if involved vehicle is: more than 95 inches wide; more than 34 feet long; operated with an overweight permit; operated with an overdimension permit; VEHICLE 1 DAMAGE CODES: Box 1 - Point of Impact [blank], Box 2 - Most Damage [blank]; VEHICLE 2 DAMAGE CODES: Box 1 - Point of Impact [blank], Box 2 - Most Damage [blank]; Enter up to three more damage codes: [blank]

7 Vehicle By: QUALITY TOWING, Towed To: NEWBURGH DPW; Vehicle By: QUALITY TOWING, Towed To: QUALITY TOWING

7 VEHICLE DAMAGE CODING: 1-13 SEE DIAGRAM ON RIGHT. 14. UNDERCARRIAGE, 15. TRAILER, 16. OVERTURNED, 17. DEMOLISHED, 18. NO DAMAGE, 19. OTHER

7 ACCIDENT DIAGRAM: See the last page of the MV-104A for the accident diagram. Cost of repairs to any one vehicle will be more than \$1000. Unknown/Unable to determine Yes No

8 Reference Marker: [blank]; Coordinates (if available): Latitude/Northing 4600617, Longitude/Easting 579606; Place Where Accident Occurred: County ORANGE, City/Village/Town of NEWBURGH, Road on which accident occurred FOSTERTOWN RD, at 1) Intersecting street N FOSTERTOWN DR

8 Accident Description/Officer's notes: The accident occurred in a police vehicle owned/operated by the Town of Newburgh Police Department while responding to an emergency. V-1 traveling n/b on New Rd, V-2 traveling w/b on Fostertown Rd near intersection with New Rd. V-1 stopped at stop sign and then proceeds n/b crossing Fostertown Rd. V-1 subsequently strikes V-2 in the driver side rear, causing V-2 to lose control and travel w/b in e/b lane of Fostertown Rd while spinning around. V-2 travels w/b

8	9	10	11	12	13	14	15	16	17 BY	18	Names of all involved	Date of Death Only	
A	1	1	4	1	34	M	11	12	6	12032et	3509	KARABELAS, TASO	
B	2	1	4	1	41	M	10	12	5			SMITH, CHARLES	
C	2	3	1	1	43	F	-	-	-			GONZALEZ, TRACEY	
D	2	4	1	1	18	M	-	-	-			SEELAND, ROBERT	
E	2	7	1	1	19	M	-	-	-			BEATTIE, RYAN	

9 Officer's Rank and Signature: SGT MICHAEL W SUMNICK, Badge # 5049, NCIC No. 13503, Precinct/Post Troop/Zone: F2, Station/Beat Sector: 31, Reviewing Officer: WHITTEL, JAMES, Date/Time Reviewed: 8/19/2014 17:39

Page 2 of 3 Pages

New York State Department of Motor Vehicles

POLICE ACCIDENT REPORT

MV-104A (6/04)

Local Codes
 5811993
 SPM2123CXJWK

AMENDED REPORT

1	Accident Date			Day of Week	Military Time	No. of Vehicles	No. Injured	No. Killed	Not Investigated at Scene	Left Scene	Police Photos	
	Month	Day	Year								<input checked="" type="checkbox"/> Yes	<input type="checkbox"/> No
	8	11	2014	Monday	15:40	2	2	0	<input type="checkbox"/>	<input type="checkbox"/>	<input checked="" type="checkbox"/>	<input type="checkbox"/>

VEHICLE BICYCLIST PEDESTRIAN OTHER PEDESTRIAN

2

3

4

5

6

7

VEHICLE DAMAGE CODING:

1-13 SEE DIAGRAM ON RIGHT.

14. UNDERCARRIAGE 17. DEMOLISHED
 18. TRAILER 19. NO DAMAGE
 16. OVERTURNED 15. OTHER

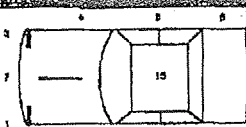

Circle the diagram below that describes the accident, or draw your own diagram in space #9. Number the vehicles.

1. Rear End	3. Left Turn	4. Right Angle	5. Right Turn	7. Head On
2. Side/Swipe (same direction)	6. Left Turn		8. Right Turn	9. Backstop (opposite direction)

9.

Cost of repairs to any one vehicle will be more than \$1000.
 Unknown/Unable to determine Yes No

Reference Marker	Coordinates (if available)	Place Where Accident Occurred:	
	Latitude/Northing	County <u>ORANGE</u>	<input type="checkbox"/> City <input type="checkbox"/> Village <input type="checkbox"/> Town of _____
	Longitude/Easting	Road on which accident occurred _____ (Route Number or Street Name)	
		at 1) Intersecting street _____ or 2) _____ of _____ (Route Number or Street Name)	

Accident Description/Officer's notes

the south shoulder and comes to rest in a ditch partially on the passenger side facing e/b. V-1 becomes disabled facing w/b on the north shoulder of Fostertown Rd at intersection with North Fostertown Rd. WITNESS #1 HONEEL A SENIOR 653 FOSTERTOWN RD WALLKILL, 12589 (845) 590-2274

ALL INVOLVED	B	9	10	11	12	13	14	16	18	17 BY	TO 18	Names of all Involved	Date of Death Only
A													
B													
C													
D													
E													
F													
G													
H													
I													
J													

Officer's Rank and Signature	SGT <i>[Signature]</i>	Badge/ID No.	NCIC No.	Precinct/Post Troop/Zone	Station/Beat Sector	Reviewing Officer	Date/Time Reviewed
Print Name in Full	MICHAEL W SUMNICK	5049	13503	F2	31	WHITTEL, JAMES	8/19/2014 17:39

Page 3 of 3 Pages

New York State Department of Motor Vehicles POLICE ACCIDENT REPORT

MV-104A (6/04)

Local Codes
5811993
SPM2123CKJWK

AMENDED REPORT

Accident Date			Day of Week	Military Time	No. of Vehicles	No. Injured	No. Killed	Not Investigated at Scene	Left Scene	Police Photos
Month	Day	Year						<input type="checkbox"/>	<input type="checkbox"/>	<input checked="" type="checkbox"/> Yes <input type="checkbox"/> No
8	11	2014	Monday	15:40	2	2	0	<input type="checkbox"/>	<input type="checkbox"/>	
								Accident Reconstructed	<input type="checkbox"/>	

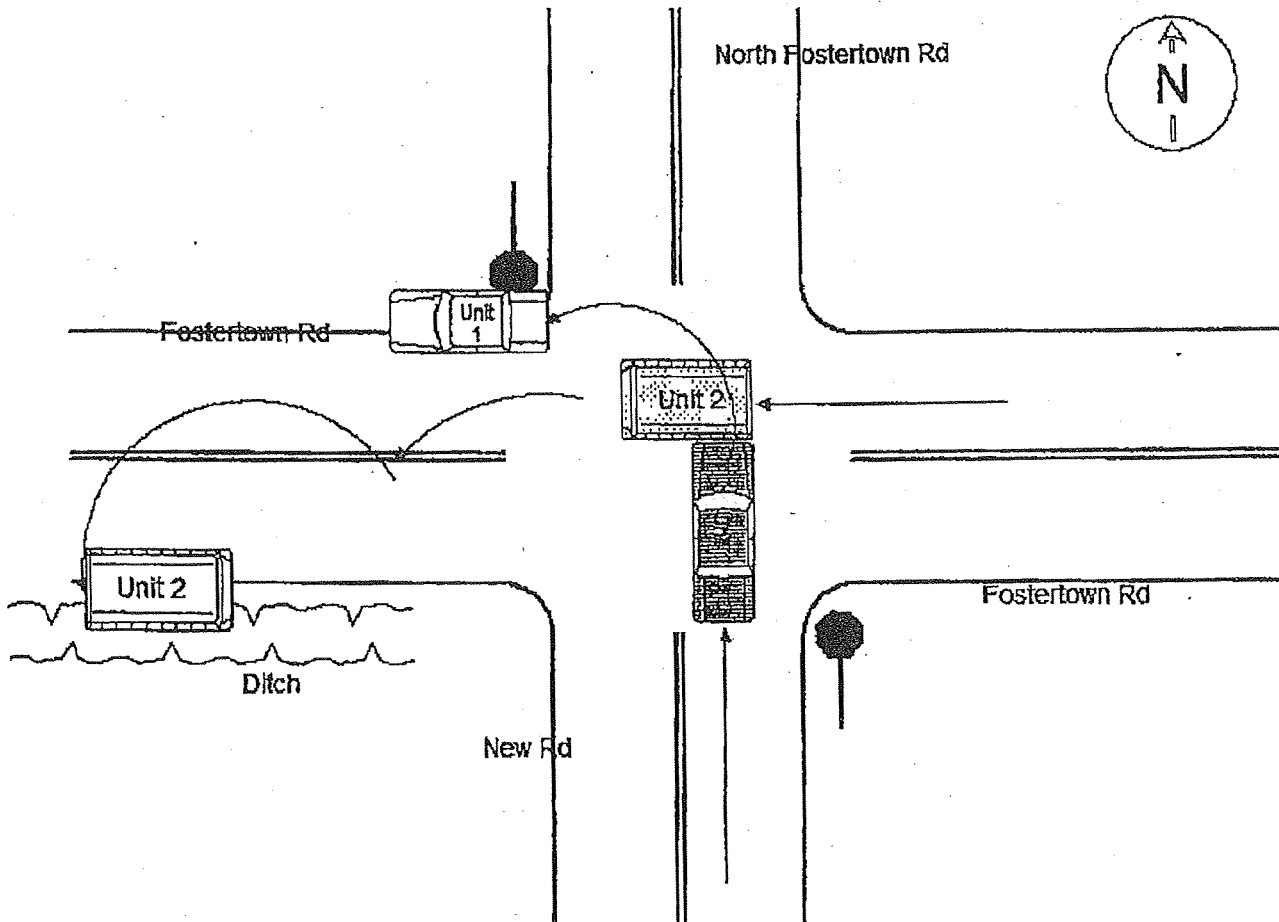

1-B4

Cindy Martinez

From: Anita Carfora <ACarfora@cenhud.com>
Sent: Wednesday, October 15, 2014 2:47 PM
To: cmmartinez@townofnewburgh.org
Subject: Street Light Request - Dogwood Hill Road
Attachments: CS-10152014144147.pdf

Importance: High

Hi there...

As per our conversation, please see attached the "Street Light Authority Order" to add 2 lights on Dogwood Hill Road. As discussed, Town Resident Joan Kaplan is requesting them stating that it is very dark and unsafe on her road.

If Central Hudson is authorized by the Town to install these lights, please have this document signed and email back to me so I may process the order...

Thank you...

Anita Carfora
Business Development Associate
610 Little Britain Road
New Windsor NY 12553
Phone (845) 563-4585
Fax (845) 563-4503
acarfora@cenhud.com

*This message contains **confidential information** and is only for the intended recipient. If the reader of this message is not the intended recipient, or an employee or agent responsible for delivering this message to the intended recipient, please notify the sender immediately by replying to this note and deleting all copies and attachments. Thank you.*

CENTRAL HUDSON GAS & ELECTRIC CORPORATION
610 LITTLE BRITAIN ROAD
NEW WINDSOR, NY 12553-6114
(845) 452-2700

STREET LIGHTING AUTHORITY ORDER

PAGE 1

TOWN OF NEWBURGH
ATTN ACCOUNTS PAYABLE
1496 ROUTE 300
NEWBURGH NY 12550-2677

ORDER NO.: H8-03309
ACCOUNT NO.: 8411-1980-00
DATE: 10/15/14

TO CENTRAL HUDSON GAS & ELECTRIC CORPORATION:

YOU ARE HEREBY AUTHORIZED TO MAKE CHANGES SPECIFIED BELOW TO THE STREET LIGHTING SERVICE FOR THE CONSOLIDATED LGTG DISTRICT #1 IN ACCORDANCE WITH A RESOLUTION DULY ADOPTED AS PROVIDED BY LAW BY THE _____ (COUNCIL/BOARD OF THE _____ OF _____ AT A MEETING HELD ON _____, 20__ AS FOLLO

ACTION:

INSTALL OR REMOVE	TYP & SIZE OF LAMP	POLE NO	RATE **	MAP & GRID	LOCATION	DATE COMPLETE	ADJ AMT
INSTALL	HPS 16000	41287	A		DOGWOOD HILLS RD		13.82
INSTALL	HPS 5800	40030	A		DOGWOOD HILLS RD		12.43

INSTALL STREET LIGHTS

- ** A. COMPANY OWNED AND MAINTAINED; ANNUAL OR SEASONAL SERVICE
- ** B. CUSTOMER OWNED/COMPANY MAINTAINED
- ** C. CUSTOMER OWNED/CUSTOMER MAINTAINED

THESE CHANGES ARE SUBJECT TO THE TERMS OF THE EXISTING STREET LIGHTING SERVICE CLASSIFICATIONS. DOES NOT INCLUDE THE COST OF ELECTRICITY.

MUNICIPALITY _____ BY _____
_____, 20 _____ TITLE _____

W.O.NO. 6686A DATE WORK COMPLETED _____ BY _____

102

Cindy Martinez

From: Anita Carfora <ACarfora@cenhud.com>
Sent: Friday, October 31, 2014 8:43 AM
To: cmmartinez@townofnewburgh.org
Subject: Street Light - Susan Drive
Attachments: CS-10312014083515.pdf

Good Morning..

As per our discussion, attached is the street light authority order for Susan Drive....

Thanks..and have a great weekend!!!

Anita Carfora
Business Development Associate
610 Little Britain Road
New Windsor NY 12553
Phone (845) 563-4585
Fax (845) 563-4503
acarfora@cenhud.com

*This message contains **confidential information** and is only for the intended recipient. If the reader of this message is not the intended recipient, or an employee or agent responsible for delivering this message to the intended recipient, please notify the sender immediately by replying to this note and deleting all copies and attachments. Thank you.*

Anthony Talanca
59 Susan Dr.
(845) 401-3086

Pole# 42156

CENTRAL HUDSON GAS & ELECTRIC CORPORATION
610 LITTLE BRITAIN ROAD
NEW WINDSOR, NY 12553-6114
(845) 452-2700

STREET LIGHTING AUTHORITY ORDER

PAGE 1

TOWN OF NEWBURGH
ATTN ACCOUNTS PAYABLE
1496 ROUTE 300
NEWBURGH NY 12550-2677

ORDER NO.: H8-03311
ACCOUNT NO.: 8411-1980-00
DATE: 10/30/14

TO CENTRAL HUDSON GAS & ELECTRIC CORPORATION:

YOU ARE HEREBY AUTHORIZED TO MAKE CHANGES SPECIFIED BELOW TO THE STREET LIGHTING SERVICE FOR THE CONSOLIDATED LGTG DISTRICT #1, IN ACCORDANCE WITH A RESOLUTION DULY ADOPTED AS PROVIDED BY LAW BY THE _____ (COUNCIL/BOARD OF THE _____ OF _____ AT A MEETING HELD ON _____, 20__ AS FOLLOW

ACTION:

INSTALL OR REMOVE	TYP & SIZE OF LAMP	POLE NO	RATE **	MAP & GRID	LOCATION	DATE COMPLETE	ADJ AMT
INSTALL	HPS	5800	42156	A	SUSAN DRIVE		12.43

ADD STREET LIGHT TO POLE #N42156

- ** A. COMPANY OWNED AND MAINTAINED; ANNUAL OR SEASONAL SERVICE
- ** B. CUSTOMER OWNED/COMPANY MAINTAINED
- ** C. CUSTOMER OWNED/CUSTOMER MAINTAINED

THESE CHANGES ARE SUBJECT TO THE TERMS OF THE EXISTING STREET LIGHTING SERVICE CLASSIFICATIONS. DOES NOT INCLUDE THE COST OF ELECTRICITY.

MUNICIPALITY _____ BY _____
_____, 20____ TITLE _____
W.O.NO. 6686A DATE WORK COMPLETED _____ BY _____

18C

Cindy Martinez

From: Mark Calderone <mark@mcsuperior.com>
Sent: Tuesday, November 04, 2014 10:16 AM
To: Cindy Martinez
Subject: Re: Town of Newburgh Lights Thanks Cindy
Attachments: Town of Nwbg. - Vermont & Maine ltg. upgrade.pdf

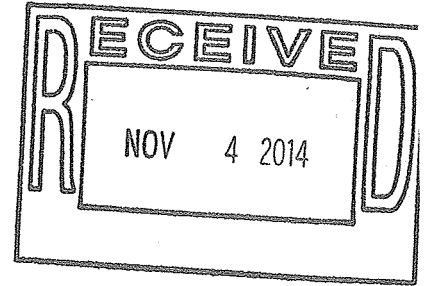

MARK J. CALDERONE
M.C.ELECTRICAL SYSTEMS, INC.
P.O. BOX 453
WALDEN, NEW YORK 12586
PHONE - 845-778-6565
CELL - 914-755-3930
FAX - 845-778-6560
EMAIL: mark@mcsuperior.com

On Tue, Nov 4, 2014 at 10:15 AM, Cindy Martinez <cmmartinez@townofnewburgh.org> wrote:

Estimate

P.O. BOX 453
WALDEN, NEW YORK
12586

PHONE 845-778-6565
FAX 845-778-6560

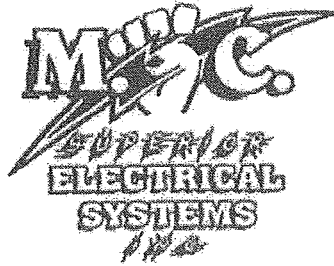

Date	Estimate #
11/3/2014	1944

Name / Address
TOWN OF NEWBURGH 1496 RTE. 300 NEWBURGH, NY 12550

Terms
Net 30

Description	Total
" VERMONT & MAINE - LIGHTING UPGRADES "	
THE FOLLOWING PRICE QUOTE IS FOR :	
- REPLACING THE EXISTING 70 WATT HIGH PRESSURE SODIUM POLE LIGHT HEADS WITH A NEW 100 WATT METAL HALIDE POLE LIGHT HEAD WITH BUILT IN PHOTOCCELL (SIMILAR IN APPEARANCE)	805.00
- COORDINATE WITH CENTRAL HUDSON TO DISCONNECT & RECONNECT THE POLES AS WE WORK ON THEM, POLES WILL BE ENERGIZED DAILY	
- REPLACE HEADS WITH THE USE OF A BUCKET TRUCK, AND A CREW OF TWO MEN	
- PRICE IS PER-POLE.	
*** ADD ALTERNATE : UPGRADE THE NEW HEAD TO A 20 WATT LED HEAD WITH BUILT IN PHOTOCCELL, SIMILAR IN APPEARANCE TO THE EXISTING.	
TOTAL ADDED = \$ 280.00	0.00
Sales Tax	

Thank you for the opportunity to bid on this job.	Total	\$805.00
---	--------------	----------

Pricing for the above Estimate is valid for 30 days.

Signature _____

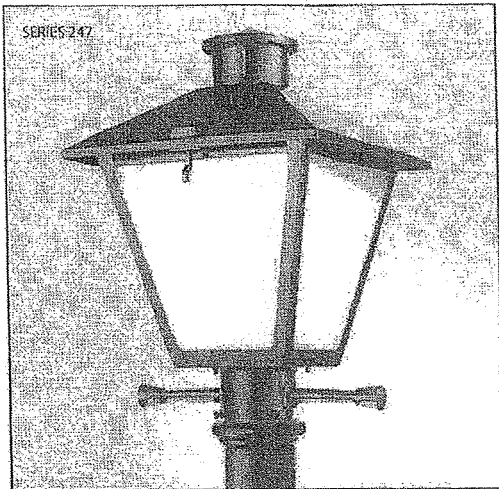

PREFERRED SELECTION CATALOG NUMBERS

Series 247

- 247 10S RN 120 R3 AY
- 247 15S RN 120 R3 AY
- 247 10S RN 120 R5 AY
- 247 15S RN 120 R5 AY

Series 247 Cutoff

- 247 10S RN 120 R2 FC TL
- 247 10M XN MT1 R2 FC TL

Decorative

Features:

- Die-cast aluminum housing and hood for long-life performance
- Die-cast trigger latch (TL) option available for easy access to internal components.
- Optical assembly designed for maximum performance
- Hinged hood and captive screw provision afford quick, easy access to electrical and optical area for relamping or servicing
- Slipfitter with three set screws allows secure installation to pole sizes 2-3/8" or 3" O.D.
- E39 mogul base socket standard
- All electrical components warranted by American Electric Lighting's 6-year guarantee
- Complies with ANSI: C136.2, C136.10, C136.15, C136.31 (regular only), C136.16 (FC only)
- Suitable for -30°C MH & / -40°C HPS

Applications:

- Streetscapes
- Walkways
- Pathways
- Parks

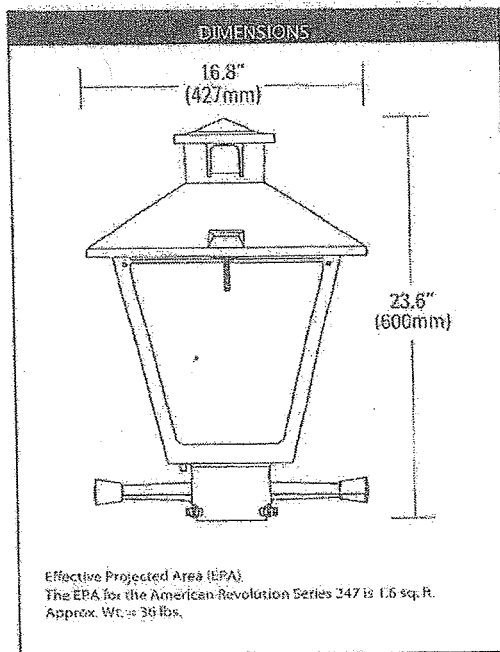

Sheet # DL-247-A



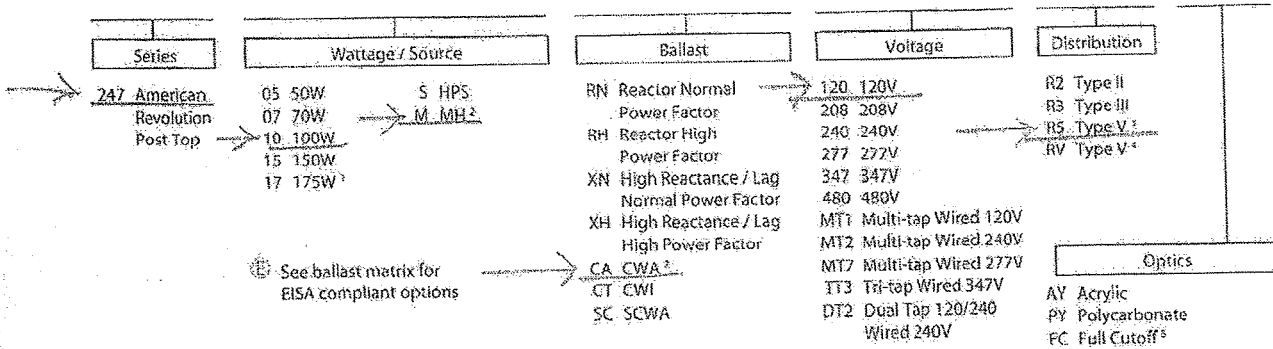

Options

Paint⁶	(blank) Black (standard) BZ Bronze DDB Dark Bronze GY Gray WH White	Lamp	LC Lamp Included, Clear LD Lamp Included, Deluxe/Coated
Terminal Block	(blank) Terminal Block (standard) T2 Wired to L1 & L2 Position T3 3 Wire Operation (L1, N, L2 Position) ⁷	Starter¹⁰	(blank) Open Board (standard) EC Encapsulated Plug-in OP Open Plug-in
Listing	UL UL Listed CS CSA Certified	Misc.	PC Photocontrol Included per Voltage Specified ⁹ SH Shorting Cap ¹⁰ SS Stainless Steel Hardware NL NEMA Label (2x2) HS House Side Shield ¹¹ TE Tool-less Entry LDR Ladder Rest ¹²
Fusing⁸	SF Single Fuse (120, 277, 347V) DF Double Fuse (208, 240, 480V)		
Photocontrol Receptacle	(blank) NEMA Photocontrol Receptacle (standard) NR No Photocontrol Receptacle ⁹		

- Notes:
- When ordered with metal halide, these wattages do not comply with California Title 20 regulations.
 - CA ballast is not available with 175W - 400W metal halide in the U.S.; must use SC
 - Four white panels
 - Four clear panels
 - Nighttime FriendlyTM optic; consult factory for distribution availability
 - Other colors available, please contact your local American Electric Lighting representative
 - T3 option only available with 240, 480, DT2, DT4, MT2
 - Not available in MT, TT, DT voltages; voids UL listing
 - PC and SH not available with NR option
 - HPS only
 - Acrylic only, Not available with FC version
 - Ships with unit, field installed



American Electric Lighting
Acuity Brands Lighting, Inc.
3825 Columbus Rd. S.W., Granville, OH 43023
Phone: 800-537-5710 Fax: 740-587-6114
www.americanelectrictlighting.com

Series 247

Watts	120	200	240	277	347	480	DT2
055	RL, RN						
075	CA, MB, RH, RN, XH, XN	CA, XH, XN	CA, MR, XH, XN	CA, XH, XN		XH, XN	CA, MB, XH, XN
07M	XH, XN	XH, XN	XH, XN	XH, XN			
105	CA, CT, MR, RH, RN, XH, XN	CA, CT, XH, XN	CA, CT, MR, XH, XN	CA, CT, XH, XN		CA	MR, XH, XN
10M	CA, XH, XN	XH, XN	XH, XN	CA, XH, XN	XH, XN	XH, XN	CA, XH, XN
135	RN						
145	RN						
155	CA, CT, RH, RN, XH, XN	CA, CT, XH, XN	CA, CT, XH, XN	CA, CT, XH, XN	XH, XN	CA	CA, CT, XH, XN
15M	XH, XN	XH, XN	XH, XN	XH, XN			
17M	SC	SC	SC	SC			SC

Series 247 continued

Watts	MT1	MT2	MT3	TT3
055				
075	CA, XH, XN	CA, XH, XN	CA, XH, XN	
07M	XH, XN	XH, XN	XH, XN	
105	CA, CT, XH, XN	CA, CT, XH, XN	CA, CT, XH, XN	
10M	XH, XN	XH, XN	XH, XN	XH, XN
135				
145				
155	CA, CT, XH, XN	CA, CT, XH, XN	CA, CT, XH, XN	XH, XN
15M	XH, XN	XH, XN	XH, XN	
17M	SC	SC	SC	

PHOTOMETRICS

247 075 R3 AY

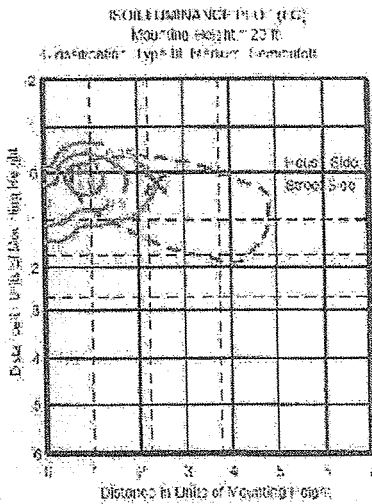

247 155 R5 AY

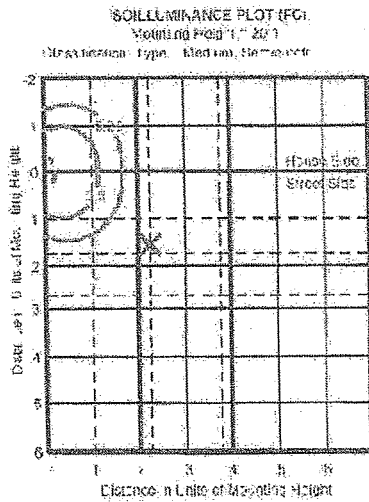

247 105 R2 FC

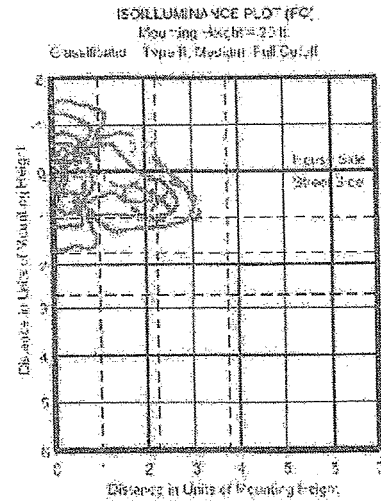

X Maximum Intensity
--- 1/2 Maximum Intensity

Decorative

Sheet 4 DL-247-A

AEL American Electric Lighting

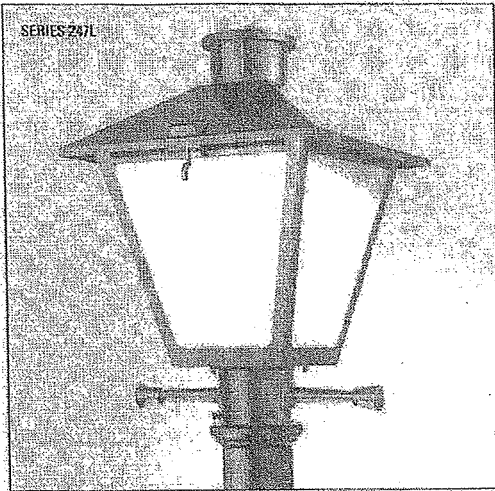

Features:

- Die-cast aluminum housing and hood for long-life performance
- Die-cast trigger latch (TL) and captive thumb screws option available for easy access to internal components
- Optical assembly designed for maximum performance, available in Type II, Type III and Type V
- Hinged hood and captive thumb screws provision afford quick, easy access to electrical and optical area for servicing.
- Slipfitter with three set screws allows secure installation to pole sizes 2-3/8" or 3" O.D.
- Complies with ANSI: C136.2, C136.10, C136.15
- CSA listed and suitable for up to 30°C ambient
- Rated L70, LED-life greater than 100,000 hours at 25°C
- Replaces up to 150W HPS light source incumbent models

Applications:

Streetscapes
Walkways
Pathways
Parks

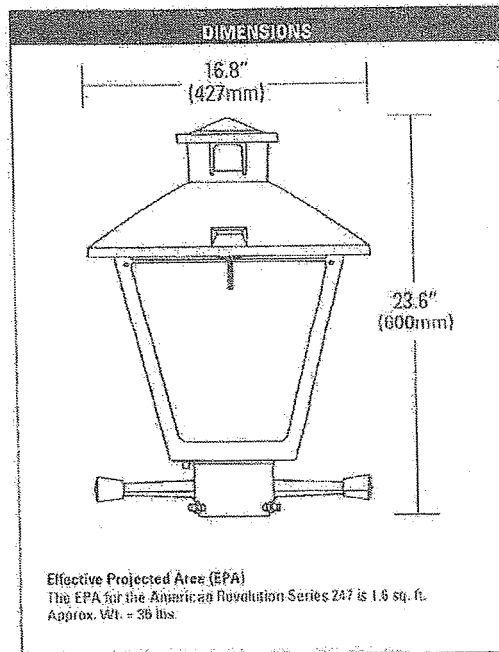

American Revolution Series 247L LED

AEL American
Electric
Lighting

Series	Performance Package	Voltage	Color Temperature (CCT)
247L American Revolution LED	20LEDE10 20 Chips, 1050 mA Driver, 72 input watts 20LEDE70 20 Chips, 700 mA Driver, 45 input watts 10LEDE10 10 Chips, 1050 mA Driver, 38 input watts 10LEDE70 10 Chips, 700 mA Driver, 25 input watts 10LEDE53 10 Chips, 525 mA Driver, 18 input watts 10LEDE35 10 Chips, 350 mA Driver, 13 input watts	MVOLT Multi-volt, 120-277V 347 347V 480 480V	3K 3000K 4K 4000K 5K 5000K

Distribution	Optics	Options				
R2 Type II R3 Type III R5 Type V	AY Acrylic PY Polycarbonate	<table border="0"> <tr> <td> Paint¹ (blank) Black (standard) GY Gray DDB Dark Bronze WH White BZ Bronze </td> <td> Photocontrol (blank) NEMA Photocontrol Receptacle (standard) NR² No Photocontrol Receptacle </td> </tr> <tr> <td colspan="2"> Miscellaneous PCSS^{3,4} Solid State Lighting Photocontrol (120-277V) PGLL^{1,5} Solid State Long Life Photocontrol SS Stainless steel hardware NL NEMA Label XL Not CSA Listed TL Tool-less Entry LDR³ Ladder Rest SH Shoring Cap DE⁶ ROAM Dimming Enabled DS DM DV-10V dimmable driver only (leads attached) HSB House Side Shield Black HSW House Side Shield White CR Enhanced Corrosion Resistant Finish </td> </tr> </table>	Paint¹ (blank) Black (standard) GY Gray DDB Dark Bronze WH White BZ Bronze	Photocontrol (blank) NEMA Photocontrol Receptacle (standard) NR ² No Photocontrol Receptacle	Miscellaneous PCSS ^{3,4} Solid State Lighting Photocontrol (120-277V) PGLL ^{1,5} Solid State Long Life Photocontrol SS Stainless steel hardware NL NEMA Label XL Not CSA Listed TL Tool-less Entry LDR ³ Ladder Rest SH Shoring Cap DE ⁶ ROAM Dimming Enabled DS DM DV-10V dimmable driver only (leads attached) HSB House Side Shield Black HSW House Side Shield White CR Enhanced Corrosion Resistant Finish	
Paint¹ (blank) Black (standard) GY Gray DDB Dark Bronze WH White BZ Bronze	Photocontrol (blank) NEMA Photocontrol Receptacle (standard) NR ² No Photocontrol Receptacle					
Miscellaneous PCSS ^{3,4} Solid State Lighting Photocontrol (120-277V) PGLL ^{1,5} Solid State Long Life Photocontrol SS Stainless steel hardware NL NEMA Label XL Not CSA Listed TL Tool-less Entry LDR ³ Ladder Rest SH Shoring Cap DE ⁶ ROAM Dimming Enabled DS DM DV-10V dimmable driver only (leads attached) HSB House Side Shield Black HSW House Side Shield White CR Enhanced Corrosion Resistant Finish						

Notes:

1. Other colors available; please contact factory
2. PC and SH not available with NR option
3. Ships with unit, field installed
4. Standard failure mode="Fail Off"
5. Photocontrols supplied with ANSI Standard Turn-On levels
6. Specifies a ROAM dimming enabled fixture with a dimming control module factory installed. NEMA photocontrol receptacle required. Additional hardware and services required. ROAM deployment must be purchased separately.



©2014 Acuity Brands Lighting, Inc. 7/14

American Electric Lighting
 Acuity Brands Lighting, Inc.
 3825 Columbus Rd. S.W., Grandville, OH 43023
 Phone: 800-254-0463 Fax: 740-349-4490
 www.americanelectriclighting.com

DLC products are listed in **BOLD**
 Non DLC products are indicated by shaded box

LED Quantity, mA, CCT	Input Watts	TOTAL LUMENS					
		R2-AV	R3-AV	R5-AV	R2-PV	R3-PV	R5-PV
20LEDE10 3k	72	3505	3585	3930	3289	3364	3688
20LEDE10 4k	72	4409	4510	4944	4136	4230	4637
20LEDE10 5k	72	4753	4862	5329	4458	4560	4998
20LEDE70 3k	45	2690	2751	3016	2522	2580	2828
20LEDE70 4k	45	3395	3473	3807	3170	3234	3554
20LEDE70 5k	45	3660	3743	4103	3417	3495	3831
10LEDE10 3k	38	1808	1849	2027	1711	1760	1918
10LEDE10 4k	38	2293	2348	2571	2152	2201	2412
10LEDE10 5k	38	2469	2526	2768	2319	2372	2600
10LEDE70 3k	25	1367	1398	1533	1301	1330	1453
10LEDE70 4k	25	1762	1804	1977	1636	1673	1834
10LEDE70 5k	25	1896	1939	2126	1764	1804	1977
10LEDE53 3k	18	1367	1398	1216	1019	1042	1142
10LEDE53 4k	18	1685	1709	1533	1279	1308	1434
10LEDE53 5k	18	1473	1506	1651	1380	1412	1547
10LEDE35 3k	13	780	798	875	732	749	821
10LEDE35 4k	13	979	1001	1097	922	942	1033
10LEDE35 5k	13	1058	1082	1186	992	1015	1112



©2014 Acuity Brands Lighting, Inc. 7/14

American Electric Lighting
 Acuity Brands Lighting, Inc.
 3825 Columbus Rd. S.W., Granville, OH 43023
 Phone: 800-754-0463 Fax: 740-349-4450
www.americanelectriclighting.com

On November 7th 2013 a vehicle struck the north side of the stone wall over the bridge on Power Mill Road. This vehicle was insured by Travelers Insurance Company
We have received a check from Travelers for \$ 5,174.00

We solicited quotes for the repair of the wall from the following

Lynn Warren Landscaping for \$ 19,900.00

R. Brewer Landscaping \$ 5,200.00 We awarded this contract on September 3rd, 2014 to Brewer Landscaping. Brewer withdrew his quote as it was more work than labor than he had estimated.

1. Albs Sons Construction has supplied a quote of \$ 7800.00 to repair the damaged cause by the vehicle.
2. He has supplied a quote of \$ 1400.00 to repair under the left side of the bridge This was not damaged by the vehicle accident.
3. Reattach Cap Stones to piers \$ 3,220.00

I verbally authorized Albs Sons Construction to perform tasks 1 and 2 for a total of \$ 8800.00 on November 3rd due to the fact the water level in the pond is low and cold weather is approaching

Alba Sons Construction

George Narkaj

(845)-728-2902

albasonsconstruction@yahoo.com

Estimate to:

Town of Newburgh

Repair the wall on the lake: We will repair the wall that was damaged by the car accident. We will try to recover all of the stones that are in the water. For the column that lost its footing, we will start with drywall below the water level and then continue with mortar above it.

NO Tax Charged

Labor Cost: \$7,800

Repair the wall underneath the left side of the bridge. I will provide the motor and cement for this project but stone will not be included.

NO Tax Charged

Labor Cost: \$1,400

Lift all of the caps that have fallen in the lake, bolt them in, and secure them so that they can't be lifted up again.

NO Tax Charged

Labor Cost: \$3,200

Total Cost: \$12,400

Note: You will supply the heavy equipment and provide road barricades (based upon what the townsperson that I spoke to had told me). I am also assuming that you will be

L. S. L. W. Corp.

dba Lynn Warren Landscaping
 18 north fostertown drive
 Newburgh, NY 12550
 (845) 564-8760

Estimate

Date	Estimate #
1/15/2014	137

Name / Address
TOWN OF NEWBURGH,BUILDING & GROUNDS 1496 ROUTE 300 Newburgh, NY 12550

			Project
Description	Qty	Cost	Total
WALL AND PILLAR REPAIR TO BRIDGE ON POWDER MILL ROAD TO ORIGINAL CONDITION. 12 X 6.5 X2 WITH CAPS 4 PILLARS 2X2X4.5 RE-USING THE ORIGINAL STONE WHEN POSSIBLE FOR THE SUM OF			
LABOR	1	15,200.00	15,200.00T
MATERIAL	1	4,700.00	4,700.00T
		Subtotal	\$19,900.00
		Sales Tax (0.00)	\$0.00
		Total	\$19,900.00

Agreed and Accepted: _____

This proposal may be withdrawn by us if not accepted within 15 days. All material is guaranteed to be as specified. All work to be completed in a workmanlike manner according to standard practices. Any alteration or deviation from the above specifications involving extra costs will be executed only upon written orders, and will become an extra charge over and above the estimate. All agreements contingent upon strikes, accidents or delays beyond our control. Owner to carry fire, tornado and other necessary insurance. Our workers are fully covered by Workmen's Compensation Insurance.

10



1789 Route 300, Newburgh, NY 12550
Phone: (845)566-1054 Fax: (845)566-0974
www.RodneyBrewerLandscape.com



PROPOSAL

Customer #	Estimate Date:	Estimate #
479	11/25/13	6793

Bill To:

Town of Newburgh Highway Department
90 Gardnertown Rd.
Newburgh, NY 12550

Install Location:

Town of Newburgh Highway Department
90 Gardnertown Rd.
Newburgh, NY 12550

Contract Details

WALL REPAIR

Repair damaged wall on Powder Mill Road; the last two sections heading east. Includes breaking down wall and using wall stone provided by the town to rebuild it.
Concrete and labor included----- \$5,200.00

*APPROVED
SEP 3 13*

We appreciate the opportunity to be of service!

Agreed and Accepted by:

Representative Signature Date Customer Signature Date

19 B
Add on



TOWN OF NEWBURGH

1496 Route 300, Newburgh, New York 12550

GIL PIAQUADIO
Deputy Supervisor
Acting as Supervisor

845-564-4552
Fax: 845-566-9486
e-mail: councilmanpiaquadio@townofnewburgh.org

November 12, 2014

Budget Transfer

I am requesting a Budget Transfer from Contingency account 001-1990-0499 to Building and Grounds Repairs to Non-Vehicle Account number 001-1620-0474 in the amount of \$ 12,400.00 to cover repair of Stone Wall and under structure repairs on Powder Mill Road

Gil Piaquadio
Deputy Supervisor
Acting as Supervisor

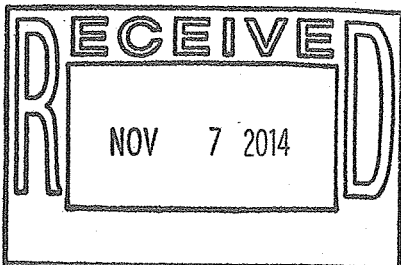

TOWN OF NEWBURGH
TOWN ENGINEER
1496 Rte. 300
Newburgh, NY 12550
(845) 564-7814

MEMORANDUM

TO: Gil Piaquadio, Deputy Supervisor & Town Board
FROM: James W. Osborne, Town Engineer *JWO*
DATE: November 7, 2014
RE: PB \ BRIGHTON GREEN (PULTE HOMES)

Pulte Homes currently has seven (7) performance bonds on file with the Town of Newburgh for both on-site and off-site improvements. Some of the bonds address some deficiencies on the site identified by the HOA; however, several of the bonds are for work that has been satisfactorily completed and they should be released. Based on this, I am recommending the release of the following securities:

1. Off-site water main extension in the amount of \$15,000.
2. Off-site drainage improvements in Meadow Hill Road and Delaware Road in the amount of \$16,100.
3. On-site water main installation in the amount of \$32,100.
4. Guaranty of the water system punch list for Highland Estates – Section 2B in the amount of \$111,500.

As the above requires Town Board action, I am requesting that this item be placed on the next available agenda for approval. If you have any questions or comments, I am available to discuss them with you.

JWO/id
cc: M. Taylor, Attorney
J. Platt, DPW Comm.
G. Canfield, Code Compliance

Dear Sir:

The Town of Newburgh is requesting an Expression of Interest (EOI) and a Statement of Qualifications (SOQ) for the above referenced project. All submittals shall be mailed or delivered to:

James Osborne, Town Engineer
Town of Newburgh Town Hall
1496 Route 300
Newburgh, New York 12550

Description of Project

The Gardnertown Road Culvert carries Gardnertown Road over the Gidneytown Creek in the Town of Newburgh. The culvert is located approximately 150 feet west of the intersection of Gardnertown Road with Gidney Avenue.

The culvert appears to consist of three distinct sections as follows from upstream to downstream: a stone arch culvert, a full diameter corrugated Metal Pipe and a corrugated metal arch on concrete footings. Each section encompasses approximately one third of the culvert length.

During Hurricane Irene / Tropical Storm Lee, the culvert became surcharged and the upstream headwall separated from the culvert and some of the stone arch section failed leading to a collapse along the edge of the westbound travel lane. Emergency repairs were made and the Town is looking to repair / rehabilitate / replace the culvert as necessary.

Requirements for SOQ

The SOQ must address the following items:

1. Firm's experience with work of similar scope and complexity;
2. Qualifications of Personnel;
3. Familiarity with Federal Highway Administration funded projects;
4. References.

Each of these are described in greater detail below:

Experience

The SOQ must contain a description of the firm's experience in designing cost effective solutions for projects of similar scope and complexity. This is especially critical as the funding for this project through the FHA is for the repair of storm-related damage resulting from Hurricane Irene. The project may or may not encompass a full replacement of the existing culvert depending on the extent of the storm related damage. The SOQ should describe the firm's proposed approach to the engineering evaluation of the culvert and subsequent design effort for this project.

Personnel

The SOQ must contain the resumes of the personnel that will be responsible for and directly working on the proposed project. The resumes must specifically show experience related to the Town of Newburgh project. The Town expects that the project team presented in the SOQ will in fact work on the project. Substitutions, if not acceptable to the Town, may result in disqualifications.

FHA Experience

The SOQ must identify the firm's experience successfully completing FHA funded projects – both on time and on budget. The SOQ should identify that the firm has worked with municipal clients on similarly sized projects and demonstrate compliance with the requirements of FHA funded projects.

References

The SOQ must contain a minimum of three references. These references should be able to attest to the firm's professional qualifications as they relate to the Town of Newburgh project and equally important, attest to the firm's qualifications in administering an FHA funded project.

All submittals must be received by no later than 4:00 pm on December __, 2014. Any questions regarding this solicitation should be addressed to my attention at the number / e-mail address shown.

Respectfully,

James W. Osborne
Town Engineer

JWO/id

cc: G. Piaquadio, Deputy Supervisor
J. Platt, DPW Comm.
T. DePew, Hwy. Supt.
C. Ryan, NYS DOT