



**McGOEY, HAUSER and EDSALL
CONSULTING ENGINEERS D.P.C.**

MARK J. EDSALL, P.E., P.P. (NY, NJ & PA)
MICHAEL W. WEEKS, P.E. (NY, NJ & PA)
MICHAEL J. LAMOREAUX, P.E. (NY, NJ, PA, VT & VA)
MATTHEW J. SICKLER, P.E. (NY & PA)
PATRICK J. HINES

Main Office
33 Airport Center Drive
Suite 202
New Windsor, New York 12553

(845) 567-3100
fax: (845) 567-3232
e-mail: mheny@mhepc.com

Principal Emeritus:
RICHARD D. McGOEY, P.E. (NY & PA)
WILLIAM J. HAUSER, P.E. (NY, NJ & PA)

**TOWN OF NEWBURGH
PLANNING BOARD
TECHNICAL REVIEW COMMENTS**

PROJECT: LANDS OF FRISCHKNECHT
PROJECT NO.: 15-06
PROJECT LOCATION: SECTION 70, BLOCK 3, LOT 1
REVIEW DATE: 2 APRIL 2015
MEETING DATE: 2 APRIL 2015
REPRESENTATIVE: JONATHAN CELLA, P.E.

1. Project will require referral to the Zoning Board of Appeals for 2 front yard variances for the existing structure on the site.
2. Project identifies a roadway dedication parcel. Information for this must be submitted for attorney review.
3. Standard notes for connection to Town's water and sewer system must be added to the plans. *A copy is attached.*
4. City of Newburgh Flow Acceptance letter is required for the new residential structure.
5. The EAF should be utilizing the NYSDEC website to fill in information regarding the project site. DEC's interactive website will provide detail information pertaining to environmental factors in the DEC database.
6. Project should address whether blasting is to occur on the site. The design of the house appears to set the easterly most portion of the building of approximately 10 feet into the hillside.
7. Highway Superintendent's comments regarding driveway location should be provided.

Respectfully submitted,

***McGoey, Hauser & Edsall
Consulting Engineers, D.P.C.***

Patrick J. Hines
Principal

MAR 25 2015

JPE
MAR 23 2015

March 9, 2015

To: Town of Newburgh Planning Board
John P. Ewasutyn, Chairman, and Planning Board Members
308 Gardnertown Road
Newburgh, New York 12550

2015-06

Re.: Initial Submission for
Proposed Two Lot Residential Subdivision for Jorg Uwe Frischknecht
2 Chevy Lane (S/B/L: 70-3-1), Town of Newburgh, Orange County, N.Y.

Dear Chairman and Planning Board Members:

Enclosed please find plans for the above referenced project. The subject parcel lies at the southeast corner of East View Road and Fifth Avenue, and has frontage on Fifth Avenue, East View Road, and Chevy Street. The 28,000 square foot parcel contains one existing residential building known as 2 Chevy Lane serviced by municipal water and sewer and lies in the Town of Newburgh R-3 residential zoning district.

This proposal is for a two lot subdivision of the parcel for single family residences serviced by municipal water and sewer. The existing residence is connected to existing municipal water and sewer in the right of way of East View Road, and the proposed residence will connect to existing facilities in Fifth Avenue.

Upon research of East View Road and Chevy Lane, it was determined that both roads are paper streets that were never dedicated to the Town and are currently privately maintained by the residences making use of them. Discussions were had with the Town Engineer, Mr. James Osborne, P.E., and he was in agreement that this subdivision would not trigger any required dedications of property to the Town along East View Road and Chevy Lane as they are considered private roads. Project plans include a dedication of property along Fifth Avenue, which is a Town Road, such that the Town will own 25' from the centerline of the road.

Project plans prepared for this project document that the zoning requirements are satisfied for both the existing residence and the proposed residences, include details for construction, and measures for temporary and permanent erosion and sedimentation control. The current owner/applicant has no current plans for construction of the new residence.

At this time we respectfully request that the submitted material be reviewed and the application be considered for the next available Town of Newburgh Planning Board agenda. Please do not hesitate to contact me with any questions or concerns related to this matter. Thank you.

Sincerely:

Jonathan Cella, P.E.

Project Engineer

51 Hunt Road, Wallkill, New York 12589

845-741-0363, jonathancellahotmail.com

TOWN OF NEWBURGH PLANNING BOARD

APPLICATION PACKAGE

for

SUBDIVISIONS

and

SITE PLANS

Procedures and Requirements

August 2005

TOWN OF NEWBURGH PLANNING BOARD
308 GARDNERTOWN ROAD
NEWBURGH, NEW YORK 12550
(845) 564-7804
fax: (845) 564-7802

August 2005

TO WHOM IT MAY CONCERN:

This package of information and forms is provided to assist the applicant in the preparation of a submission of a site plan, subdivision or lot line change to the Town of Newburgh Planning Board. In most cases the application will be prepared initially by a licensed professional engineer, architect, surveyor or by a land planner. Since in almost every case such professional will be required for the process, they should be retained as early as possible.

Procedurally, the applicant should contact the Planning Board to discuss the potential project and obtain the necessary forms and regulations.

The Zoning and Subdivision Regulations of the Town of Newburgh require that the applicant must present plans to the Secretary of the Planning Board. When your application is complete, it will be placed on the next AVAILABLE agenda. Submittals must be handed in to the Planning Board Secretary at least 10 days prior to the next meeting, but the date of the appearance at a meeting will be determined by the next available time slot, not necessarily the next meeting. You will be notified of the date, time and place of your meeting.

A minimum of FOURTEEN (14) sets of FOLDED PLANS for a major or minor subdivision or a site plan must be submitted with a COMPLETED application, and FIFTEEN (15) sets of plans must be submitted if plans need to be submitted to the Town of Newburgh Traffic Consultant. This completed application must include a LONG FORM OR FULL EAF for every project except lot line changes, 2 lot subdivisions under 3 acres or site plans impacting less than one acre, along with a NARRATIVE of the proposed project. The narrative should include the action being taken, the size of the parcel, what zone the parcel is in, the water and sewer information, any Zoning Board of Appeals relief needed, and whether the parcel is on a private or town road. Complex or unusual projects should be discussed in greater detail.

Upon initial review of a Short Form, the Planning Board may require specific additional environmental information or the preparation of a Long Form. Long Form part 1 should be completed by the applicant. The Board will review and may modify Part 2 prior to making a decision on the SEQRA aspect of the project.

All fees for consulting and professional services that the Planning Board incurs during the review of the applications will be the responsibility of the applicant. An advance deposit for these fees will be required and will be placed in an escrow account with the Town. If the escrow account falls below the 40% of the initial deposit, the applicant will be required to immediately make an additional deposit to the escrow account prior to any further review of the project application by the Planning Board.

Very truly yours,

JOHN P. EWASUTYN, Chairman
Town of Newburgh Planning Board

TOWN OF NEWBURGH
APPLICATION FOR
SUBDIVISION/SITE PLAN REVIEW

RETURN TO: Town of Newburgh Planning Board
308 Gardnertown Road
Newburgh, New York 12550

DATE RECEIVED: _____ TOWN FILE NO: _____
(Application fee returnable with this application)

1. Title of Subdivision/Site Plan (Project name):
TWO LOT RESIDENTIAL SUBDIVISION FOR JORG UWE FRISCHKNECHT

2. Owner of Lands to be reviewed:

Name JORG UWE FRISCHKNECHT
Address 2 OAK RIDGE DRIVE
NEW WINDSOR, NEW YORK 12553
Phone 845-222-3884

3. Applicant Information (If different than owner):

Name SAME
Address _____

Representative N/A
Phone _____
Fax _____
Email _____

4. Subdivision/Site Plan prepared by:

Name JONATHAN CELLA, P.E.
Address 51 HUNT ROAD
WALLKILL, NEW YORK 12589
Phone/Fax 845-741-0363 jonathancella@hotmail.com

5. Location of lands to be reviewed:

2 CHEVY LANE (S/B/L: 70-3-1)

6. Zone R-3 DISTRICT

Acrage 28,001 S.F. = 0.64 ACRES

Fire District GOODWILL

School District NEWBURGH

7. Tax Map: Section 70 Block 3 Lot 1

B. Project Description and Purpose of Review:

Number of existing lots	<u>1</u>	Number of proposed lots	<u>2</u>
Lot line change	<u>N/A</u>		
Site plan review	<u>N/A</u>		
Clearing and grading	<u>N/A</u>		
Other	<u>N/A</u>		

PROVIDE A WRITTEN SINGLE PAGE DESCRIPTION OR NARRATIVE OF THE PROJECT

9. Easements or other restrictions on property:
(Describe generally) N/A

10. The undersigned hereby requests approval by the Planning Board of the above identified application and scheduling for an appearance on an agenda:

Signature [Handwritten Signature] Title OWNER

Date: 3/17/2015

NOTE: If property abuts and has its access to a County or State Highway or road, the following information must be placed on the subdivision map or site plan: entrance location, entrance profile, sizing of pipe (minimum length of pipe to be 24 feet).

TOWN OF NEWBURGH PLANNING BOARD

TWO LOT RESIDENTIAL SUBDIVISION FOR JORG UWE FRISCHKNECHT
PROJECT NAME

CHECKLIST FOR MAJOR/MINOR SUBDIVISION AND/OR SITE PLAN

I. The following items shall be submitted with a COMPLETED Planning Board Application Form.

1. Environmental Assessment Form As Required
2. Proxy Statement
3. Application Fees
4. Completed Checklist (Automatic rejection of application without checklist)

II. The following checklist items shall be incorporated on the Subdivision Plat or Site Plan prior to consideration of being placed on the Planning Board Agenda. Non-submittal of the checklist will result in application rejection.

1. Name and address of applicant
2. Name and address of owner (if different from applicant)
3. Subdivision or Site Plan and Location
4. Tax Map Data (Section-Block-Lot)
5. Location map at a scale of 1" = 2,000 ft. or less on a tax map or USCGS map base only with property outlined
6. Zoning table showing what is required in the particular zone and what applicant is proposing. A table is to be provided for each proposed lot
7. N/A Show zoning boundary if any portion of proposed site is within or adjacent to a different zone
8. Date of plan preparation and/or plan revisions
9. Scale the plan is drawn to (Max 1" = 100')
10. North Arrow pointing generally up

11. Surveyor's Certification
12. Surveyor's seal and signature
13. Name of adjoining owners
14. N/A Wetlands and 100 ft. buffer zone with an appropriate note regarding D.E.C. or A.C.O.E. requirements
15. N/A Flood plain boundaries
16. N/A Certified sewerage system design and placement by a Licensed Professional Engineer must be shown on plans in accordance with Local Law #1 1989
17. Metes and bounds of all lots
18. Name and width of adjacent streets; the road boundary is to be a minimum of 25 ft. from the physical center line of the street
19. N/A Show existing or proposed easements (note restrictions)
20. Right-of-way width and Rights of Access and Utility Placement
21. N/A Road profile and typical section (minimum traveled surface, excluding shoulders, is to be 18 ft. wide)
22. Lot area (in sq. ft. for each lot less than 2 acres)
23. Number of lots including residual lot
24. N/A Show any existing waterways
25. N/A A note stating a road maintenance agreement is to be filed in the County Clerk's Office where applicable
26. Applicable note pertaining to owners review and concurrence with plat together with owner's signature
27. Show any improvements, i.e. drainage systems, water lines, sewer lines, etc.
28. Show all existing houses, accessory structures, wells and septic systems on and within 200 ft. of the parcel to be subdivided
29. Show topographical data with 2 or 5 ft. contours on initial submission

30. N/A Indicate any reference to a previous subdivision, i.e. filed map number, date and previous lot number
31. N/A If a private road, Town Board approval of name is required, and notes on the plan that no town services will be provided and a street sign (per town specs) is to be furnished and installed
32. N/A Number of acres to be cleared or timber harvested
33. N/A Estimated or known cubic yards of material to be excavated and removed from the site
34. N/A Estimated or known cubic yards of fill required
35. N/A The amount of grading expected or known to be required to bring the site to readiness
36. N/A Type and amount of site preparation which falls within the 100 ft. buffer strip of wetlands or within the Critical Environmental Area. Please explain in sq. ft. or cubic yards.
- _____
- _____
- _____
37. N/A Any amount of site preparation within a 100 year floodplain or any water course on the site. Please explain in sq. ft. or cubic yards.
- _____
- _____
- _____

The plan for the proposed subdivision or site has been prepared in accordance with this checklist.

By: JONATHAN CELLA
Jonathan Cella
 Licensed Professional

Date: 3/7/2015

This list is designed to be a guide ONLY. The Town of Newburgh Planning Board may require additional notes or revisions prior to granting approval.

Prepared 8/11/05
 STATEMENT TO APPLICANTS

RE: TOWN OF NEWBURGH CLEARING AND GRADING LAW

The Town of Newburgh Clearing and Grading Control Law requires a separate permit for most site preparation activities, including clearing, grading, tree cutting, excavating and filling. Site preparation activities performed following site plan or subdivision approval by the Planning Board may be exempt from the permit application, public hearing, fee and bonding requirements of the law provided the subdivision or site plan application has been reviewed for conformance with the clearing and grading law and the approval conditioned on compliance with the standards set forth in the law. Completion of the attached form will enable the Planning Board to review your application for conformance with the law's requirements. In the event it is not completed you may be required to apply for a separated permit for your site preparation activities. A sediment and erosion control plan and a plan showing the areas to be cleared, filled, graded or subjected to tree cutting, the types of vegetation affected and the proposed disposition of the destroyed vegetation must accompany the form. A SEQRA long form or full EAF should be utilized to discuss any environmental impacts and must accompany the application.

TOWN OF NEWBURGH
APPLICATION FOR CLEARING AND GRADING

Name of applicant: _____ N/A _____

Name of owner on premises: _____

Address of owner: _____

Telephone number of owner: _____

Telephone number of applicant: _____

State whether applicant is owner, lessee, agent, architect, engineer or contractor: _____

Location of land on which proposed work will be done: _____

Section: _____ Block: _____ Lot: _____ Sub. Div.: _____

Zoning District of Property: _____ Size of Lot: _____

Area of lot to be cleared or graded: _____

Proposed completion of date: _____

Name of contractor/agent, if different than owner: _____

Address: _____

Telephone number: _____

Date of Planning Board Approval: _____ (if required)

I hereby agree to hold the Town of Newburgh harmless from any claims arising from the proposed activity.

Signature of owner: _____ Date: _____

Signature of applicant (if different than owner): _____

TOWN ACTION:

Examined: _____ 20 _____

Approved: _____ 20 _____

Disapproved: _____ 20 _____

FEE LAW SUMMARY

PENDING APPLICATIONS

All applicants with matters pending before the Planning Board as of the effective date of this local law shall be required to post an escrow in the manner and upon the terms and conditions set forth below:

- (a) The Planning Board, in consultation with the applicant, shall compute the amount of the escrow to be posted with the Town. Such amount shall be reasonably related to the costs attendant to the Town's review of the application as of the effective date of this local law. Under no circumstances shall the escrow include amounts attributable to any costs incurred by the Town prior to the effective date of this local law.
- (b) Once computed and established by Resolution of the Planning Board, the applicant shall, within fifteen (15) days of said resolution, post escrow fees with the Secretary of the Planning Board. Failure to deliver the said escrow fees may result in delay of the further processing of the application.

SEVERABILITY

In the event a court of law determined that any provision of this chapter is unenforceable, then only that provision shall be affected and all other provisions shall be fully enforceable.

EFFECTIVE DATE:

This local law shall take effect immediately upon filing in the Office of the Secretary of State.

FEE ACKNOWLEDGEMENT

The town of Newburgh Municipal Code sets forth the schedule of fees for applications to the Planning Board. The signing of this application indicates your acknowledgement of responsibility for payment of these fees to the Planning Board for review of this application, including, but not limited to escrow fees for professional services (planner/consultant, engineering, legal), public hearing and site inspection. Applicant's submissions and resubmissions are not complete and will not be considered by the planning board or placed upon its agenda unless all outstanding fees have been paid. Fees incurred after the stamping of plans will remain the responsibility of the applicant prior to approval of a building permit or certificate of occupancy. Fee schedules are available from the Planning Board Secretary and are on the Town's website.

JORG UWE FRISCHKNECHT
APPLICANT'S NAME (printed)

J. Frischknecht
APPLICANTS SIGNATURE

3/7/2015
DATE

Note: if the property abuts and has access to a County or State Highway or road, the following information must be placed on the subdivision map: entrance location, entrance profile, sizing of drainage pipe (minimum length of pipe to be twenty-four (24) feet).

PROXY

(OWNER) G.K.D. PROPERTIES, L.L.C., DEPOSES AND SAYS THAT HE/SHE

RESIDES AT 26 ADAMS DRIVE, MONTGOMERY, NEW YORK 12549

IN THE COUNTY OF ORANGE

AND STATE OF NEW YORK

AND THAT HE/SHE IS THE OWNER IN FEE OF _____

20 BAUER LANE (S/B/L: 12 - 1 - 6)

WHICH IS THE PREMISES DESCRIBED IN THE FOREGOING
APPLICATION AS DESCRIBED THEREIN TO THE TOWN OF NEWBURGH
PLANNING BOARD AND JONATHAN CELLA, P.E. IS AUTHORIZED
TO REPRESENT THEM AT MEETINGS OF SAID BOARD.

DATED: 03.03.15

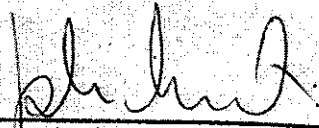

OWNERS SIGNATURE

JORG UWE FRISCHKNECHT

OWNERS NAME (printed)

NAMES OF ADDITIONAL
REPRESENTATIVES



WITNESS SIGNATURE

NOTARY

EVELYN SFRAGA

WITNESS NAME (printed)

NOTARY

March 3, 2015

EVELYN SFRAGA
Notary Public, State of New York
Qualified in Orange County
Registration No. 01SF5081547
Commission Expires July 7, 2015

PLANNING BOARD DISCLAIMER STATEMENT
TO APPLICANTS

The applicant is advised that the Town of Newburgh Municipal Code, which contains the Town's Zoning Law, is subject to amendment. Submission of an application to this Board does not grant the applicant any right to continued review under the Code's current standards and requirements. It is possible that the applicant will be required to meet changed standards or new Code requirements made while the application is pending.

An approval by this Board does not constitute permission, nor grant any right to connect to or use municipal services such as sewer, water or roads. It is the applicant's responsibility to apply for and obtain the Town of Newburgh and other agency approvals not within this Board's authority to grant.

The applicant hereby acknowledges, consents, and agrees to the above.

3/7/2015

DATED

JORG UWE FRISCHKNECHT

APPLICANT'S NAME (printed)



APPLICANT'S SIGNATURE

**DISCLOSURE ADDENDUM STATEMENT TO APPLICATION,
PETITION AND REQUEST**

Mindful of the provisions of Section 809 of the General Municipal Law of the State of New York, and of the Penal provisions thereof as well, the undersigned applicant states that no State Officer, Officer or Employee of the Town of Newburgh, or Orange County, has any interest, financial or otherwise, in this application or with, or in the applicant as defined in said Statute, except the following person or persons who is or are represented to have only the following type of interest, in the nature and to the extent hereinafter indicated:

 X NONE

_____ NAME, ADDRESS, RELATIONSHIP OR INTEREST
(financial or otherwise)

This disclosure addendum statement is annexed to and made a part of the petition, application and request made by the undersigned applicant to the following Board or Officer of the Town of Newburgh.

_____ TOWN BOARD
 X PLANNING BOARD
_____ ZONING BOARD OF APPEALS
_____ ZONING ENFORCEMENT OFFICER
_____ BUILDING INSPECTOR
_____ OTHER

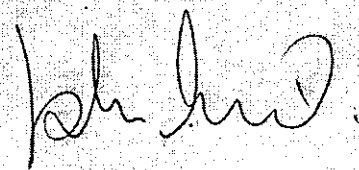

JORG UWE FRISCHKNECHT
INDIVIDUAL APPLICANT

 03.03.15
DATED

March 3, 2015

*STATE OF New York
County of ORANGE*

Evelyn Spraga
EVELYN SPRAGA, NOTARY Public

CORPORATE OR PARTNERSHIP APPLICANT

BY: _____
(Pres.) (Partner) (Vice-Pres.)
(Sec.) (Treas.)

EVELYN SPRAGA
Notary Public, State of New York
Qualified in Orange County
Registration No. 01SF5081547
Commission Expires July 7, 2015

AGRICULTURAL NOTE

(Required to be placed on all plans where property lies within 500 feet of land in active agricultural production or operation)

Property adjacent to lots (1) is in active agricultural operation and production and residents must be aware that such property is protected by New York State "Right to Farm Laws" as regulated by the Department of Agriculture and Markets. From time to time during and prior to the normal growing season land and crops may be sprayed from the ground or by air, manure may be applied, and periodic noise may occur from machinery operation at various times throughout the day. Residents should be aware of this action by the adjacent property owners.

(1) Specific lots adjacent to the active farming area which are impacted shall be inserted in this space.

AGRICULTURAL DATA STATEMENT

(Required pursuant to Agricultural and Markets Law §305-a for applications for site plan approvals, use variances and subdivision approvals that will occur on property within a County Agricultural District containing an active farm operation or on property with boundaries within five hundred feet of an active farm operation located in a County Agricultural District)

Name and address of the applicant: N/A

Description of the proposed project: _____

Location of the proposed project: _____

Name(s) and address(es) of any owner(s) of land within a County Agricultural District containing active farming operations and located within five hundred feet of the boundary of the project property: _____

A tax map or other map showing the site of the proposed project relative to the location of the identified farm operations must be attached to this form.

APPLICANT'S SIGNATURE

DATE

ARCHITECTURAL REVIEW FORM
TOWN OF NEWBURGH PLANNING BOARD

DATE: _____

NAME OF PROJECT: _____

The applicant is to submit in writing the following items prior to signing of the site plans.

EXTERIOR FINISH (skin of the building):

Type (steel, wood, block, split block, etc.)

COLOR OF THE EXTERIOR OF BUILDING:

ACCENT TRIM:

Location: _____

Color: _____

Type (material): _____

PARAPET (all roof top mechanicals are to be screened on all four sides):

ROOF:

Type (gabled, flat, etc.): _____

Material (shingles, metal, tar & sand, etc.): _____

Color: _____

WINDOWS/SHUTTERS:

Color (also trim if different): _____

Type: _____

DOORS:

Color: _____

Type (if different than standard door entrée): _____

SIGN:

Color: _____

Material: _____

Square footage of signage of site: _____

Please print name and title (owner, agent, builder, superintendent of job, etc.)

Signature

ARCHITECTURAL REVIEW

The Town of Newburgh Planning Board had been authorized to act as the Architectural Review Board for all: site plans, projects involving ten or more dwelling units, and any construction that would affect the character of a neighborhood under Section §185-59 of the Town Code (Zoning Law).

In order to perform this task, at some point prior to final approval, the applicant shall provide the Planning Board with elevations of buildings for all sides and a written (separately or on drawings) description of the materials, colors and textures to be used in construction. Plans shall also include topographical information and any screening of portions of the buildings, either existing or proposed.

Samples of the material and colors to be used shall either be submitted to the Planning Board or brought to the meeting at which architectural review will be discussed.

Full Environmental Assessment Form
Part 1 - Project and Setting

Instructions for Completing Part 1

Part 1 is to be completed by the applicant or project sponsor. Responses become part of the application for approval or funding, are subject to public review, and may be subject to further verification.

Complete Part 1 based on information currently available. If additional research or investigation would be needed to fully respond to any item, please answer as thoroughly as possible based on current information; indicate whether missing information does not exist, or is not reasonably available to the sponsor; and, when possible, generally describe work or studies which would be necessary to update or fully develop that information.

Applicants/sponsors must complete all items in Sections A & B. In Sections C, D & E, most items contain an initial question that must be answered either "Yes" or "No". If the answer to the initial question is "Yes", complete the sub-questions that follow. If the answer to the initial question is "No", proceed to the next question. Section F allows the project sponsor to identify and attach any additional information. Section G requires the name and signature of the project sponsor to verify that the information contained in Part 1 is accurate and complete.

A. Project and Sponsor Information.

Name of Action or Project: PROPOSED TWO LOT RESIDENTIAL SUBDIVISION FOR JORG UWE FRISCHKNECHT		
Project Location (describe, and attach a general location map): 2 CHEVY LANE (S/B/L: 70-3-1), TOWN OF NEWBURGH, ORANGE COUNTY, NEW YORK-		
Brief Description of Proposed Action (include purpose or need): PROPOSED TWO LOT RESIDENTIAL SUBDIVISION OF 0.64 ACRES WITH ONE EXISTING RESIDENCE. THE PARCEL IS SERVICED BY MUNICIPAL WATER AND SEWER. PROPOSED CONSTRUCTION WILL INCLUDE ONE ADDITIONAL SINGLE FAMILY RESIDENCE SERVICED BY TOWN WATER AND SEWER.		
Name of Applicant/Sponsor: JORG UWE FRISCHKNECHT	Telephone: 845-222-3884	E-Mail:
Address: 2 OAK RIDGE DRIVE		
City/PO: NEW WINDSOR	State: NEW YORK	Zip Code: 12553
Project Contact (if not same as sponsor; give name and title/role): JONATHAN CELLA, P.E., (PROJECT ENGINEER)	Telephone: 845-741-0363	E-Mail: jonathancell@hotmai.com
Address: 51 HUNT ROAD		
City/PO: WALLKILL	State: NEW YORK	Zip Code: 12589
Property Owner (if not same as sponsor): SAME AS APPLICANT	Telephone:	E-Mail:
Address:		
City/PO:	State:	Zip Code:

B. Government Approvals

B. Government Approvals Funding, or Sponsorship. ("Funding" includes grants, loans, tax relief, and any other forms of financial assistance.)

Government Entity	If Yes: Identify Agency and Approval(s) Required	Application Date (Actual or projected)
a. City Council, Town Board, <input type="checkbox"/> Yes <input checked="" type="checkbox"/> No or Village Board of Trustees		
b. City, Town or Village Planning Board or Commission <input checked="" type="checkbox"/> Yes <input type="checkbox"/> No	TOWN PLANNING BOARD SUBDIVISION APPROVAL	
c. City Council, Town or Village Zoning Board of Appeals <input type="checkbox"/> Yes <input checked="" type="checkbox"/> No		
d. Other local agencies <input type="checkbox"/> Yes <input checked="" type="checkbox"/> No		
e. County agencies <input type="checkbox"/> Yes <input checked="" type="checkbox"/> No		
f. Regional agencies <input type="checkbox"/> Yes <input checked="" type="checkbox"/> No		
g. State agencies <input type="checkbox"/> Yes <input checked="" type="checkbox"/> No		
h. Federal agencies <input type="checkbox"/> Yes <input checked="" type="checkbox"/> No		
i. Coastal Resources. i. Is the project site within a Coastal Area, or the waterfront area of a Designated Inland Waterway? <input type="checkbox"/> Yes <input checked="" type="checkbox"/> No If Yes, ii. Is the project site located in a community with an approved Local Waterfront Revitalization Program? <input type="checkbox"/> Yes <input checked="" type="checkbox"/> No iii. Is the project site within a Coastal Erosion Hazard Area? <input type="checkbox"/> Yes <input checked="" type="checkbox"/> No		

C. Planning and Zoning

C.1. Planning and zoning actions.

Will administrative or legislative adoption, or amendment of a plan, local law, ordinance, rule or regulation be the only approval(s) which must be granted to enable the proposed action to proceed? Yes No

- If Yes, complete sections C, F and G.
- If No, proceed to question C.2 and complete all remaining sections and questions in Part 1

C.2. Adopted land use plans.

a. Do any municipally- adopted (city, town, village or county) comprehensive land use plan(s) include the site where the proposed action would be located? Yes No

If Yes, does the comprehensive plan include specific recommendations for the site where the proposed action would be located? Yes No

b. Is the site of the proposed action within any local or regional special planning district (for example: Greenway Brownfield Opportunity Area (BOA); designated State or Federal heritage area; watershed management plan; or other?) Yes No

If Yes, identify the plan(s):

c. Is the proposed action located wholly or partially within an area listed in an adopted municipal open space plan, or an adopted municipal farmland protection plan? Yes No

If Yes, identify the plan(s):

C.3. Zoning

a. Is the site of the proposed action located in a municipality with an adopted zoning law or ordinance. Yes No
If Yes, what is the zoning classification(s) including any applicable overlay district?
R-3 SINGLE FAMILY RESIDENTIAL

b. Is the use permitted or allowed by a special or conditional use permit? Yes No

c. Is a zoning change requested as part of the proposed action? Yes No

If Yes,
i. What is the proposed new zoning for the site? _____

C.4. Existing community services.

a. In what school district is the project site located? NEWBURGH CENTRAL SCHOOL DISTRICT

b. What police or other public protection forces serve the project site?
TOWN OF NEWBURGH

c. Which fire protection and emergency medical services serve the project site?
GOODWILL

d. What parks serve the project site?
TOWN OF NEWBURGH

D. Project Details

D.1. Proposed and Potential Development

a. What is the general nature of the proposed action (e.g., residential, industrial, commercial, recreational; if mixed, include all components)?
RESIDENTIAL

b. a. Total acreage of the site of the proposed action? 0.64 acres

b. Total acreage to be physically disturbed? 0.30 acres

c. Total acreage (project site and any contiguous properties) owned or controlled by the applicant or project sponsor? 0.64 acres

c. Is the proposed action an expansion of an existing project or use? Yes No

i. If Yes, what is the approximate percentage of the proposed expansion and identify the units (e.g., acres, miles, housing units, square feet)? % 100 Units: ONE ADDITIONAL SINGLE FAMILY RESIDENCE

d. Is the proposed action a subdivision, or does it include a subdivision? Yes No

If Yes,
i. Purpose or type of subdivision? (e.g., residential, industrial, commercial; if mixed, specify types)
RESIDENTIAL

ii. Is a cluster/conservation layout proposed? Yes No

iii. Number of lots proposed? 2

iv. Minimum and maximum proposed lot sizes? Minimum 0.3 Maximum 0.3

e. Will proposed action be constructed in multiple phases? Yes No

i. If No, anticipated period of construction: _____ months

ii. If Yes:

• Total number of phases anticipated _____

• Anticipated commencement date of phase 1 (including demolition) _____ month _____ year

• Anticipated completion date of final phase _____ month _____ year

• Generally describe connections or relationships among phases, including any contingencies where progress of one phase may determine timing or duration of future phases: _____

f. Does the project include new residential uses? Yes No
 If Yes, show numbers of units proposed.

	<u>One Family</u>	<u>Two Family</u>	<u>Three Family</u>	<u>Multiple Family (four or more)</u>
Initial Phase	ONE	_____	_____	_____
At completion of all phases	ONE	_____	_____	_____

g. Does the proposed action include new non-residential construction (including expansions)? Yes No
 If Yes,

i. Total number of structures _____

ii. Dimensions (in feet) of largest proposed structure: _____ height; _____ width; and _____ length

iii. Approximate extent of building space to be heated or cooled: _____ square feet

h. Does the proposed action include construction or other activities that will result in the impoundment of any liquids, such as creation of a water supply, reservoir, pond, lake, waste lagoon or other storage? Yes No
 If Yes,

i. Purpose of the impoundment: _____

ii. If a water impoundment, the principal source of the water: Ground water Surface water streams Other specify: _____

iii. If other than water, identify the type of impounded/contained liquids and their source. _____

iv. Approximate size of the proposed impoundment. Volume: _____ million gallons; surface area: _____ acres

v. Dimensions of the proposed dam or impounding structure: _____ height; _____ length

vi. Construction method/materials for the proposed dam or impounding structure (e.g., earth fill, rock, wood, concrete): _____

D.2. Project Operations

a. Does the proposed action include any excavation, mining, or dredging, during construction, operations, or both? Yes No
 (Not including general site preparation, grading or installation of utilities or foundations where all excavated materials will remain onsite)
 If Yes:

i. What is the purpose of the excavation or dredging? _____

ii. How much material (including rock, earth, sediments, etc.) is proposed to be removed from the site?

- Volume (specify tons or cubic yards): _____
- Over what duration of time? _____

iii. Describe nature and characteristics of materials to be excavated or dredged, and plans to use, manage or dispose of them. _____

iv. Will there be onsite dewatering or processing of excavated materials? Yes No
 If yes, describe. _____

v. What is the total area to be dredged or excavated? _____ acres

vi. What is the maximum area to be worked at any one time? _____ acres

vii. What would be the maximum depth of excavation or dredging? _____ feet

viii. Will the excavation require blasting? Yes No

ix. Summarize site reclamation goals and plan: _____

b. Would the proposed action cause or result in alteration of, increase or decrease in size of, or encroachment into any existing wetland, waterbody, shoreline, beach or adjacent area? Yes No
 If Yes:

i. Identify the wetland or waterbody which would be affected (by name, water index number, wetland map number or geographic description): _____

ii. Describe how the proposed action would affect that waterbody or wetland, e.g. excavation, fill, placement of structures, or alteration of channels, banks and shorelines. Indicate extent of activities, alterations and additions in square feet or acres:

iii. Will proposed action cause or result in disturbance to bottom sediments? Yes No

If Yes, describe: _____

iv. Will proposed action cause or result in the destruction or removal of aquatic vegetation? Yes No

If Yes:

- acres of aquatic vegetation proposed to be removed: _____
- expected acreage of aquatic vegetation remaining after project completion: _____
- purpose of proposed removal (e.g. beach clearing, invasive species control, boat access): _____
- proposed method of plant removal: _____
- if chemical/herbicide treatment will be used, specify product(s): _____

v. Describe any proposed reclamation/mitigation following disturbance: _____

c. Will the proposed action use, or create a new demand for water? Yes No

If Yes:

i. Total anticipated water usage/demand per day: 520 gallons/day

ii. Will the proposed action obtain water from an existing public water supply? Yes No

If Yes:

- Name of district or service area: TOWN OF NEWBURGH
- Does the existing public water supply have capacity to serve the proposal? Yes No
- Is the project site in the existing district? Yes No
- Is expansion of the district needed? Yes No
- Do existing lines serve the project site? Yes No

iii. Will line extension within an existing district be necessary to supply the project? Yes No

If Yes:

- Describe extensions or capacity expansions proposed to serve this project: _____
- Source(s) of supply for the district: _____

iv. Is a new water supply district or service area proposed to be formed to serve the project site? Yes No

If Yes:

- Applicant/sponsor for new district: _____
- Date application submitted or anticipated: _____
- Proposed source(s) of supply for new district: _____

v. If a public water supply will not be used, describe plans to provide water supply for the project: _____

vi. If water supply will be from wells (public or private), maximum pumping capacity: _____ gallons/minute.

d. Will the proposed action generate liquid wastes? Yes No

If Yes:

i. Total anticipated liquid waste generation per day: 520 gallons/day

ii. Nature of liquid wastes to be generated (e.g., sanitary wastewater, industrial; if combination, describe all components and approximate volumes or proportions of each): SANITARY WASTEWATER FROM RESIDENTIAL HOME

iii. Will the proposed action use any existing public wastewater treatment facilities? Yes No

If Yes:

- Name of wastewater treatment plant to be used: CITY OF NEWBURGH
- Name of district: CITY OF NEWBURGH
- Does the existing wastewater treatment plant have capacity to serve the project? Yes No
- Is the project site in the existing district? Yes No
- Is expansion of the district needed? Yes No

- Do existing sewer lines serve the project site? Yes No
 - Will line extension within an existing district be necessary to serve the project? Yes No
- If Yes:
- Describe extensions or capacity expansions proposed to serve this project: _____

- iv. Will a new wastewater (sewage) treatment district be formed to serve the project site? Yes No
- If Yes:
- Applicant/sponsor for new district: _____
 - Date application submitted or anticipated: _____
 - What is the receiving water for the wastewater discharge? _____

v. If public facilities will not be used, describe plans to provide wastewater treatment for the project, including specifying proposed receiving water (name and classification if surface discharge, or describe subsurface disposal plans):

vi. Describe any plans or designs to capture, recycle or reuse liquid waste: _____

- e. Will the proposed action disturb more than one acre and create stormwater runoff, either from new point sources (i.e. ditches, pipes, swales, curbs, gutters or other concentrated flows of stormwater) or non-point source (i.e. sheet flow) during construction or post construction? Yes No

- If Yes:
- i. How much impervious surface will the project create in relation to total size of project parcel?
- _____ Square feet or _____ acres (impervious surface)
- _____ Square feet or _____ acres (parcel size)

ii. Describe types of new point sources. _____

iii. Where will the stormwater runoff be directed (i.e. on-site stormwater management facility/structures, adjacent properties, groundwater, on-site surface water or off-site surface waters)?

- If to surface waters, identify receiving water bodies or wetlands: _____

- Will stormwater runoff flow to adjacent properties? Yes No

iv. Does proposed plan minimize impervious surfaces, use pervious materials or collect and re-use stormwater? Yes No

f. Does the proposed action include, or will it use on-site, one or more sources of air emissions, including fuel combustion, waste incineration, or other processes or operations? Yes No

If Yes, identify:

i. Mobile sources during project operations (e.g., heavy equipment, fleet or delivery vehicles)

ii. Stationary sources during construction (e.g., power generation, structural heating, batch plant, crushers)

iii. Stationary sources during operations (e.g., process emissions, large boilers, electric generation)

g. Will any air emission sources named in D.2.f (above), require a NY State Air Registration, Air Facility Permit, or Federal Clean Air Act Title IV or Title V Permit? Yes No

If Yes:

i. Is the project site located in an Air quality non-attainment area? (Area routinely or periodically fails to meet ambient air quality standards for all or some parts of the year) Yes No

ii. In addition to emissions as calculated in the application, the project will generate:

- _____ Tons/year (short tons) of Carbon Dioxide (CO₂)
- _____ Tons/year (short tons) of Nitrous Oxide (N₂O)
- _____ Tons/year (short tons) of Perfluorocarbons (PFCs)
- _____ Tons/year (short tons) of Sulfur Hexafluoride (SF₆)
- _____ Tons/year (short tons) of Carbon Dioxide equivalent of Hydrofluorocarbons (HFCs)
- _____ Tons/year (short tons) of Hazardous Air Pollutants (HAPs)

h. Will the proposed action generate or emit methane (including, but not limited to, sewage treatment plants, landfills, composting facilities)? Yes No

If Yes:

i. Estimate methane generation in tons/year (metric): _____

ii. Describe any methane capture, control or elimination measures included in project design (e.g., combustion to generate heat or electricity, flaring): _____

i. Will the proposed action result in the release of air pollutants from open-air operations or processes, such as quarry or landfill operations? Yes No

If Yes: Describe operations and nature of emissions (e.g., diesel exhaust, rock particulates/dust): _____

j. Will the proposed action result in a substantial increase in traffic above present levels or generate substantial new demand for transportation facilities or services? Yes No

If Yes:

i. When is the peak traffic expected (Check all that apply): Morning Evening Weekend
 Randomly between hours of _____ to _____

ii. For commercial activities only, projected number of semi-trailer truck trips/day: _____

iii. Parking spaces: Existing _____ Proposed _____ Net increase/decrease _____

iv. Does the proposed action include any shared use parking? Yes No

v. If the proposed action includes any modification of existing roads, creation of new roads or change in existing access, describe: _____

vi. Are public/private transportation service(s) or facilities available within 1/2 mile of the proposed site? Yes No

vii. Will the proposed action include access to public transportation or accommodations for use of hybrid, electric or other alternative fueled vehicles? Yes No

viii. Will the proposed action include plans for pedestrian or bicycle accommodations for connections to existing pedestrian or bicycle routes? Yes No

k. Will the proposed action (for commercial or industrial projects only) generate new or additional demand for energy? Yes No

If Yes:

i. Estimate annual electricity demand during operation of the proposed action: _____

ii. Anticipated sources/suppliers of electricity for the project (e.g., on-site combustion, on-site renewable, via grid/local utility, or other): _____

iii. Will the proposed action require a new, or an upgrade to, an existing substation? Yes No

l. Hours of operation. Answer all items which apply.

<p>i. During Construction:</p> <ul style="list-style-type: none"> • Monday - Friday: _____ • Saturday: _____ • Sunday: _____ • Holidays: _____ 	<p>ii. During Operations:</p> <ul style="list-style-type: none"> • Monday - Friday: _____ • Saturday: _____ • Sunday: _____ • Holidays: _____
--	---

m. Will the proposed action produce noise that will exceed existing ambient noise levels during construction, operation, or both? Yes No

If yes:
i. Provide details including sources, time of day and duration:

ii. Will proposed action remove existing natural barriers that could act as a noise barrier or screen? Yes No
Describe: _____

n. Will the proposed action have outdoor lighting? Yes No

If yes:
i. Describe source(s), location(s), height of fixture(s), direction/aim, and proximity to nearest occupied structures:
RESIDENTIAL LIGHTING FOR SIDEWALKS AND DRIVEWAYS

ii. Will proposed action remove existing natural barriers that could act as a light barrier or screen? Yes No
Describe: _____

o. Does the proposed action have the potential to produce odors for more than one hour per day? Yes No
If Yes, describe possible sources, potential frequency and duration of odor emissions, and proximity to nearest occupied structures: _____

p. Will the proposed action include any bulk storage of petroleum (combined capacity of over 1,100 gallons) or chemical products 185 gallons in above ground storage or any amount in underground storage? Yes No

If Yes:
i. Product(s) to be stored _____
ii. Volume(s) _____ per unit time _____ (e.g., month, year)
iii. Generally describe proposed storage facilities: _____

q. Will the proposed action (commercial, industrial and recreational projects only) use pesticides (i.e., herbicides, insecticides) during construction or operation? Yes No

If Yes:
i. Describe proposed treatment(s):

ii. Will the proposed action use Integrated Pest Management Practices? Yes No

r. Will the proposed action (commercial or industrial projects only) involve or require the management or disposal of solid waste (excluding hazardous materials)? Yes No

If Yes:
i. Describe any solid waste(s) to be generated during construction or operation of the facility:
• Construction: _____ tons per _____ (unit of time)
• Operation : _____ tons per _____ (unit of time)

ii. Describe any proposals for on-site minimization, recycling or reuse of materials to avoid disposal as solid waste:
• Construction: _____
• Operation: _____

iii. Proposed disposal methods/facilities for solid waste generated on-site:
• Construction: _____
• Operation: _____

s. Does the proposed action include construction or modification of a solid waste management facility? Yes No

If Yes:

i. Type of management or handling of waste proposed for the site (e.g., recycling or transfer station, composting, landfill, or other disposal activities): _____

ii. Anticipated rate of disposal/processing:

- _____ Tons/month, if transfer or other non-combustion/thermal treatment, or
- _____ Tons/hour, if combustion or thermal treatment

iii. If landfill, anticipated site life: _____ years

t. Will proposed action at the site involve the commercial generation, treatment, storage, or disposal of hazardous waste? Yes No

If Yes:

i. Name(s) of all hazardous wastes or constituents to be generated, handled or managed at facility: _____

ii. Generally describe processes or activities involving hazardous wastes or constituents: _____

iii. Specify amount to be handled or generated _____ tons/month

iv. Describe any proposals for on-site minimization, recycling or reuse of hazardous constituents: _____

v. Will any hazardous wastes be disposed at an existing offsite hazardous waste facility? Yes No

If Yes: provide name and location of facility: _____

If No: describe proposed management of any hazardous wastes which will not be sent to a hazardous waste facility: _____

E. Site and Setting of Proposed Action

E.1. Land uses on and surrounding the project site

a. Existing land uses.

i. Check all uses that occur on, adjoining and near the project site.

Urban Industrial Commercial Residential (suburban) Rural (non-farm)

Forest Agriculture Aquatic Other (specify): _____

ii. If mix of uses, generally describe: _____

b. Land uses and covertypes on the project site.

Land use or Covertype	Current Acreage	Acreage After Project Completion	Change (Acres +/-)
• Roads, buildings, and other paved or impervious surfaces	0.1 ACRES	0.2 ACRES	+0.1 ACRES
• Forested	0.00	0.00	0.00
• Meadows, grasslands or brushlands (non-agricultural, including abandoned agricultural)	0.5	0.4	-0.1
• Agricultural (includes active orchards, field, greenhouse etc.)	0.00	0.00	0.00
• Surface water features (lakes, ponds, streams, rivers, etc.)	0.00	0.00	0.00
• Wetlands (freshwater or tidal)	0.00	0.00	0.00
• Non-vegetated (bare rock, earth or fill)	0.00	0.00	0.00
• Other Describe: _____			

c. Is the project site presently used by members of the community for public recreation? Yes No
 i. If Yes: explain: _____

d. Are there any facilities serving children, the elderly, people with disabilities (e.g., schools, hospitals, licensed day care centers, or group homes) within 1500 feet of the project site? Yes No
 If Yes,
 i. Identify Facilities: _____

e. Does the project site contain an existing dam? Yes No
 If Yes:
 i. Dimensions of the dam and impoundment:
 • Dam height: _____ feet
 • Dam length: _____ feet
 • Surface area: _____ acres
 • Volume impounded: _____ gallons OR acre-feet
 ii. Dam's existing hazard classification: _____
 iii. Provide date and summarize results of last inspection: _____

f. Has the project site ever been used as a municipal, commercial or industrial solid waste management facility, or does the project site adjoin property which is now, or was at one time, used as a solid waste management facility? Yes No
 If Yes: Yes No
 i. Has the facility been formally closed?
 • If yes, cite sources/documentation: _____
 ii. Describe the location of the project site relative to the boundaries of the solid waste management facility: _____

 iii. Describe any development constraints due to the prior solid waste activities: _____

g. Have hazardous wastes been generated, treated and/or disposed of at the site, or does the project site adjoin property which is now or was at one time used to commercially treat, store and/or dispose of hazardous waste? Yes No
 If Yes:
 i. Describe waste(s) handled and waste management activities, including approximate time when activities occurred: _____

h. Potential contamination history. Has there been a reported spill at the proposed project site, or have any remedial actions been conducted at or adjacent to the proposed site? Yes No
 If Yes: Yes No
 i. Is any portion of the site listed on the NYSDEC Spills Incidents database or Environmental Site Remediation database? Check all that apply:
 Yes - Spills Incidents database Provide DEC ID number(s): _____
 Yes - Environmental Site Remediation database Provide DEC ID number(s): _____
 Neither database
 ii. If site has been subject of RCRA corrective activities, describe control measures: _____

 iii. Is the project within 2000 feet of any site in the NYSDEC Environmental Site Remediation database? Yes No
 If yes, provide DEC ID number(s): _____
 iv. If yes to (i), (ii) or (iii) above, describe current status of site(s): _____

v. Is the project site subject to an institutional control limiting property uses? Yes No

- If yes, DEC site ID number: _____
- Describe the type of institutional control (e.g., deed restriction or easement): _____
- Describe any use limitations: _____
- Describe any engineering controls: _____
- Will the project affect the institutional or engineering controls in place? Yes No
- Explain: _____

E.2. Natural Resources On or Near Project Site

a. What is the average depth to bedrock on the project site? GREATER THAN 3 feet

b. Are there bedrock outcroppings on the project site? Yes No
 If Yes, what proportion of the site is comprised of bedrock outcroppings? _____ %

c. Predominant soil type(s) present on project site: LOAM 100% %
 _____ %
 _____ %

d. What is the average depth to the water table on the project site? Average: >6' feet

e. Drainage status of project site soils: Well Drained: _____ % of site
 Moderately Well Drained: 100 % of site
 Poorly Drained: _____ % of site

f. Approximate proportion of proposed action site with slopes: 0-10%: 60 % of site
 10-15%: _____ % of site
 15% or greater: 40 % of site

g. Are there any unique geologic features on the project site? Yes No
 If Yes, describe: _____

h. Surface water features.

i. Does any portion of the project site contain wetlands or other waterbodies (including streams, rivers, ponds or lakes)? Yes No

ii. Do any wetlands or other waterbodies adjoin the project site? Yes No

If Yes to either i or ii, continue. If No, skip to E.2.i.

iii. Are any of the wetlands or waterbodies within or adjoining the project site regulated by any federal, state or local agency? Yes No

iv. For each identified regulated wetland and waterbody on the project site, provide the following information:

- Streams: Name _____ Classification _____
- Lakes or Ponds: Name _____ Classification _____
- Wetlands: Name _____ Approximate Size _____
- Wetland No. (if regulated by DEC) _____

v. Are any of the above water bodies listed in the most recent compilation of NYS water quality-impaired waterbodies? Yes No

If yes, name of impaired water body/bodies and basis for listing as impaired: _____

i. Is the project site in a designated Floodway? Yes No

j. Is the project site in the 100 year Floodplain? Yes No

k. Is the project site in the 500 year Floodplain? Yes No

l. Is the project site located over, or immediately adjoining, a primary, principal or sole source aquifer? Yes No

If Yes:
 i. Name of aquifer: _____

m. Identify the predominant wildlife species that occupy or use the project site: N/A

n. Does the project site contain a designated significant natural community? Yes No
 If Yes:
 i. Describe the habitat/community (composition, function, and basis for designation): _____

 ii. Source(s) of description or evaluation: _____
 iii. Extent of community/habitat:
 • Currently: _____ acres
 • Following completion of project as proposed: _____ acres
 • Gain or loss (indicate + or -): _____ acres

o. Does project site contain any species of plant or animal that is listed by the federal government or NYS as endangered or threatened, or does it contain any areas identified as habitat for an endangered or threatened species? Yes No

p. Does the project site contain any species of plant or animal that is listed by NYS as rare, or as a species of special concern? Yes No

q. Is the project site or adjoining area currently used for hunting, trapping, fishing or shell fishing? Yes No
 If yes, give a brief description of how the proposed action may affect that use: _____

E.3. Designated Public Resources On or Near Project Site

a. Is the project site, or any portion of it, located in a designated agricultural district certified pursuant to Agriculture and Markets Law, Article 25-AA, Section 303 and 304? Yes No
 If Yes, provide county plus district name/number: _____

b. Are agricultural lands consisting of highly productive soils present? Yes No
 i. If Yes: acreage(s) on project site? _____
 ii. Source(s) of soil rating(s): _____

c. Does the project site contain all or part of, or is it substantially contiguous to, a registered National Natural Landmark? Yes No
 If Yes:
 i. Nature of the natural landmark: Biological Community Geological Feature
 ii. Provide brief description of landmark, including values behind designation and approximate size/extent: _____

d. Is the project site located in or does it adjoin a state listed Critical Environmental Area? Yes No
 If Yes:
 i. CEA name: _____
 ii. Basis for designation: _____
 iii. Designating agency and date: _____

e. Does the project site contain, or is it substantially contiguous to, a building, archaeological site, or district which is listed on, or has been nominated by the NYS Board of Historic Preservation for inclusion on, the State or National Register of Historic Places?	<input type="checkbox"/> Yes <input checked="" type="checkbox"/> No
If Yes:	
i. Nature of historic/archaeological resource: <input type="checkbox"/> Archaeological Site <input type="checkbox"/> Historic Building or District	
ii. Name: _____	
iii. Brief description of attributes on which listing is based: _____	
f. Is the project site, or any portion of it, located in or adjacent to an area designated as sensitive for archaeological sites on the NY State Historic Preservation Office (SHPO) archaeological site inventory?	<input type="checkbox"/> Yes <input checked="" type="checkbox"/> No
g. Have additional archaeological or historic site(s) or resources been identified on the project site?	<input type="checkbox"/> Yes <input checked="" type="checkbox"/> No
If Yes:	
i. Describe possible resource(s): _____	
ii. Basis for identification: _____	
h. Is the project site within five miles of any officially designated and publicly accessible federal, state, or local scenic or aesthetic resource?	<input type="checkbox"/> Yes <input checked="" type="checkbox"/> No
If Yes:	
i. Identify resource: _____	
ii. Nature of, or basis for, designation (e.g., established highway overlook, state or local park, state historic trail or scenic byway, etc.): _____	
iii. Distance between project and resource: _____ miles.	
i. Is the project site located within a designated river corridor under the Wild, Scenic and Recreational Rivers Program 6 NYCRR 666?	<input type="checkbox"/> Yes <input checked="" type="checkbox"/> No
If Yes:	
i. Identify the name of the river and its designation: _____	
ii. Is the activity consistent with development restrictions contained in 6NYCRR Part 666?	
	<input type="checkbox"/> Yes <input type="checkbox"/> No

F. Additional Information

Attach any additional information which may be needed to clarify your project.

If you have identified any adverse impacts which could be associated with your proposal, please describe those impacts plus any measures which you propose to avoid or minimize them.

G. Verification

I certify that the information provided is true to the best of my knowledge.

Applicant/Sponsor Name JONATHAN CELLA, P.E. Date MARCH 8, 2015

Signature  Title PROJECT ENGINEER

Full Environmental Assessment Form
Part 2 - Identification of Potential Project Impacts

Part 2 is to be completed by the lead agency. Part 2 is designed to help the lead agency inventory all potential resources that could be affected by a proposed project or action. We recognize that the lead agency's reviewer(s) will not necessarily be environmental professionals. So, the questions are designed to walk a reviewer through the assessment process by providing a series of questions that can be answered using the information found in Part 1. To further assist the lead agency in completing Part 2, the form identifies the most relevant questions in Part 1 that will provide the information needed to answer the Part 2 question. When Part 2 is completed, the lead agency will have identified the relevant environmental areas that may be impacted by the proposed activity.

If the lead agency is a state agency and the action is in any Coastal Area, complete the Coastal Assessment Form before proceeding with this assessment.

Tips for completing Part 2:

- Review all of the information provided in Part 1.
- Review any application, maps, supporting materials and the Full EAF Workbook.
- Answer each of the 18 questions in Part 2.
- If you answer "Yes" to a numbered question, please complete all the questions that follow in that section.
- If you answer "No" to a numbered question, move on to the next numbered question.
- Check appropriate column to indicate the anticipated size of the impact.
- Proposed projects that would exceed a numeric threshold contained in a question should result in the reviewing agency checking the box "Moderate to large impact may occur."
- The reviewer is not expected to be an expert in environmental analysis.
- If you are not sure or undecided about the size of an impact, it may help to review the sub-questions for the general question and consult the workbook.
- When answering a question consider all components of the proposed activity, that is, the "whole action".
- Consider the possibility for long-term and cumulative impacts as well as direct impacts.
- Answer the question in a reasonable manner considering the scale and context of the project.

1. Impact on Land Proposed action may involve construction on, or physical alteration of, the land surface of the proposed site. (See Part 1, D.1) <i>If "Yes", answer questions a - j. If "No", move on to Section 2.</i>			
		<input checked="" type="checkbox"/> NO	<input type="checkbox"/> YES
	Relevant Part I Question(s)	No, or small impact may occur	Moderate to large impact may occur
a. The proposed action may involve construction on land where depth to water table is less than 3 feet.	E2d	<input type="checkbox"/>	<input type="checkbox"/>
b. The proposed action may involve construction on slopes of 15% or greater.	E2f	<input type="checkbox"/>	<input type="checkbox"/>
c. The proposed action may involve construction on land where bedrock is exposed, or generally within 5 feet of existing ground surface.	E2a	<input type="checkbox"/>	<input type="checkbox"/>
d. The proposed action may involve the excavation and removal of more than 1,000 tons of natural material.	D2a	<input type="checkbox"/>	<input type="checkbox"/>
e. The proposed action may involve construction that continues for more than one year or in multiple phases.	D1e	<input type="checkbox"/>	<input type="checkbox"/>
f. The proposed action may result in increased erosion, whether from physical disturbance or vegetation removal (including from treatment by herbicides).	D2c, D2q	<input type="checkbox"/>	<input type="checkbox"/>
g. The proposed action is, or may be, located within a Coastal Erosion hazard area.	B1i	<input type="checkbox"/>	<input type="checkbox"/>
h. Other impacts: _____ _____		<input type="checkbox"/>	<input type="checkbox"/>

2. Impact on Geological Features

The proposed action may result in the modification or destruction of, or inhibit access to, any unique or unusual land forms on the site (e.g., cliffs, dunes, minerals, fossils, caves). (See Part 1. E.2.g)

NO

YES

If "Yes", answer questions a - c. If "No", move on to Section 3.

	Relevant Part I Question(s)	No, or small impact may occur	Moderate to large impact may occur
a. Identify the specific land form(s) attached: _____ _____	E2g	<input type="checkbox"/>	<input type="checkbox"/>
b. The proposed action may affect or is adjacent to a geological feature listed as a registered National Natural Landmark. Specific feature: _____	E3c	<input type="checkbox"/>	<input type="checkbox"/>
c. Other impacts: _____ _____		<input type="checkbox"/>	<input type="checkbox"/>

3. Impacts on Surface Water

The proposed action may affect one or more wetlands or other surface water bodies (e.g., streams, rivers, ponds or lakes). (See Part 1. D.2, E.2.h)

NO

YES

If "Yes", answer questions a - l. If "No", move on to Section 4.

	Relevant Part I Question(s)	No, or small impact may occur	Moderate to large impact may occur
a. The proposed action may create a new water body.	D2b, D1h	<input type="checkbox"/>	<input type="checkbox"/>
b. The proposed action may result in an increase or decrease of over 10% or more than a 10 acre increase or decrease in the surface area of any body of water.	D2b	<input type="checkbox"/>	<input type="checkbox"/>
c. The proposed action may involve dredging more than 100 cubic yards of material from a wetland or water body.	D2a	<input type="checkbox"/>	<input type="checkbox"/>
d. The proposed action may involve construction within or adjoining a freshwater or tidal wetland, or in the bed or banks of any other water body.	E2h	<input type="checkbox"/>	<input type="checkbox"/>
e. The proposed action may create turbidity in a waterbody, either from upland erosion, runoff or by disturbing bottom sediments.	D2a, D2h	<input type="checkbox"/>	<input type="checkbox"/>
f. The proposed action may include construction of one or more intake(s) for withdrawal of water from surface water.	D2c	<input type="checkbox"/>	<input type="checkbox"/>
g. The proposed action may include construction of one or more outfall(s) for discharge of wastewater to surface water(s).	D2d	<input type="checkbox"/>	<input type="checkbox"/>
h. The proposed action may cause soil erosion, or otherwise create a source of stormwater discharge that may lead to siltation or other degradation of receiving water bodies.	D2e	<input type="checkbox"/>	<input type="checkbox"/>
i. The proposed action may affect the water quality of any water bodies within or downstream of the site of the proposed action.	E2h	<input type="checkbox"/>	<input type="checkbox"/>
j. The proposed action may involve the application of pesticides or herbicides in or around any water body.	D2q, E2h	<input type="checkbox"/>	<input type="checkbox"/>
k. The proposed action may require the construction of new, or expansion of existing, wastewater treatment facilities.	D1a, D2d	<input type="checkbox"/>	<input type="checkbox"/>

I. Other impacts: _____ _____		<input type="checkbox"/>	<input type="checkbox"/>
----------------------------------	--	--------------------------	--------------------------

4. Impact on groundwater The proposed action may result in new or additional use of ground water, or may have the potential to introduce contaminants to ground water or an aquifer. (See Part 1. D.2.a, D.2.c, D.2.d, D.2.p, D.2.q, D.2.t) <i>If "Yes", answer questions a - h. If "No", move on to Section 5.</i>				<input checked="" type="checkbox"/> NO	<input type="checkbox"/> YES
	Relevant Part I Question(s)	No, or small impact may occur	Moderate to large impact may occur		
a. The proposed action may require new water supply wells, or create additional demand on supplies from existing water supply wells.	D2c	<input type="checkbox"/>	<input type="checkbox"/>		
b. Water supply demand from the proposed action may exceed safe and sustainable withdrawal capacity rate of the local supply or aquifer. Cite Source: _____	D2c	<input type="checkbox"/>	<input type="checkbox"/>		
c. The proposed action may allow or result in residential uses in areas without water and sewer services.	D1a, D2c	<input type="checkbox"/>	<input type="checkbox"/>		
d. The proposed action may include or require wastewater discharged to groundwater.	D2d, E2l	<input type="checkbox"/>	<input type="checkbox"/>		
e. The proposed action may result in the construction of water supply wells in locations where groundwater is, or is suspected to be, contaminated.	D2c, E1f, E1g, E1h	<input type="checkbox"/>	<input type="checkbox"/>		
f. The proposed action may require the bulk storage of petroleum or chemical products over ground water or an aquifer.	D2p, E2l	<input type="checkbox"/>	<input type="checkbox"/>		
g. The proposed action may involve the commercial application of pesticides within 100 feet of potable drinking water or irrigation sources.	E2h, D2q, E2l, D2c	<input type="checkbox"/>	<input type="checkbox"/>		
h. Other impacts: _____ _____		<input type="checkbox"/>	<input type="checkbox"/>		

5. Impact on Flooding The proposed action may result in development on lands subject to flooding. (See Part 1. E.2) <i>If "Yes", answer questions a - g. If "No", move on to Section 6.</i>				<input checked="" type="checkbox"/> NO	<input type="checkbox"/> YES
	Relevant Part I Question(s)	No, or small impact may occur	Moderate to large impact may occur		
a. The proposed action may result in development in a designated floodway.	E2i	<input type="checkbox"/>	<input type="checkbox"/>		
b. The proposed action may result in development within a 100 year floodplain.	E2j	<input type="checkbox"/>	<input type="checkbox"/>		
c. The proposed action may result in development within a 500 year floodplain.	E2k	<input type="checkbox"/>	<input type="checkbox"/>		
d. The proposed action may result in, or require, modification of existing drainage patterns.	D2b, D2e	<input type="checkbox"/>	<input type="checkbox"/>		
e. The proposed action may change flood water flows that contribute to flooding.	D2b, E2i, E2j, E2k	<input type="checkbox"/>	<input type="checkbox"/>		
f. If there is a dam located on the site of the proposed action, is the dam in need of repair, or upgrade?	E1e	<input type="checkbox"/>	<input type="checkbox"/>		

g. Other impacts: _____ _____		<input type="checkbox"/>	<input type="checkbox"/>
----------------------------------	--	--------------------------	--------------------------

6. Impacts on Air			
The proposed action may include a state regulated air emission source. (See Part 1. D.2.f., D.2.h, D.2.g) <i>If "Yes", answer questions a - f. If "No", move on to Section 7.</i>		<input checked="" type="checkbox"/> NO	<input type="checkbox"/> YES
	Relevant Part I Question(s)	No, or small impact may occur	Moderate to large impact may occur
a. If the proposed action requires federal or state air emission permits, the action may also emit one or more greenhouse gases at or above the following levels: i. More than 1000 tons/year of carbon dioxide (CO ₂) ii. More than 3.5 tons/year of nitrous oxide (N ₂ O) iii. More than 1000 tons/year of carbon equivalent of perfluorocarbons (PFCs) iv. More than .045 tons/year of sulfur hexafluoride (SF ₆) v. More than 1000 tons/year of carbon dioxide equivalent of hydrochloroflouorocarbons (HFCs) emissions vi. 43 tons/year or more of methane	D2g D2g D2g D2g D2g D2h	<input type="checkbox"/> <input type="checkbox"/> <input type="checkbox"/> <input type="checkbox"/> <input type="checkbox"/> <input type="checkbox"/>	<input type="checkbox"/> <input type="checkbox"/> <input type="checkbox"/> <input type="checkbox"/> <input type="checkbox"/> <input type="checkbox"/>
b. The proposed action may generate 10 tons/year or more of any one designated hazardous air pollutant, or 25 tons/year or more of any combination of such hazardous air pollutants.	D2g	<input type="checkbox"/>	<input type="checkbox"/>
c. The proposed action may require a state air registration, or may produce an emissions rate of total contaminants that may exceed 5 lbs. per hour, or may include a heat source capable of producing more than 10 million BTU's per hour.	D2f, D2g	<input type="checkbox"/>	<input type="checkbox"/>
d. The proposed action may reach 50% of any of the thresholds in "a" through "c", above.	D2g	<input type="checkbox"/>	<input type="checkbox"/>
e. The proposed action may result in the combustion or thermal treatment of more than 1 ton of refuse per hour.	D2s	<input type="checkbox"/>	<input type="checkbox"/>
f. Other impacts: _____ _____		<input type="checkbox"/>	<input type="checkbox"/>

7. Impact on Plants and Animals			
The proposed action may result in a loss of flora or fauna. (See Part 1. E.2. m.-q.) <i>If "Yes", answer questions a - j. If "No", move on to Section 8.</i>		<input checked="" type="checkbox"/> NO	<input type="checkbox"/> YES
	Relevant Part I Question(s)	No, or small impact may occur	Moderate to large impact may occur
a. The proposed action may cause reduction in population or loss of individuals of any threatened or endangered species, as listed by New York State or the Federal government, that use the site, or are found on, over, or near the site.	E2o	<input type="checkbox"/>	<input type="checkbox"/>
b. The proposed action may result in a reduction or degradation of any habitat used by any rare, threatened or endangered species, as listed by New York State or the federal government.	E2o	<input type="checkbox"/>	<input type="checkbox"/>
c. The proposed action may cause reduction in population, or loss of individuals, of any species of special concern or conservation need, as listed by New York State or the Federal government, that use the site, or are found on, over, or near the site.	E2p	<input type="checkbox"/>	<input type="checkbox"/>
d. The proposed action may result in a reduction or degradation of any habitat used by any species of special concern and conservation need, as listed by New York State or the Federal government.	E2p	<input type="checkbox"/>	<input type="checkbox"/>

e. The proposed action may diminish the capacity of a registered National Natural Landmark to support the biological community it was established to protect.	E3c	<input type="checkbox"/>	<input type="checkbox"/>
f. The proposed action may result in the removal of, or ground disturbance in, any portion of a designated significant natural community. Source: _____	E2n	<input type="checkbox"/>	<input type="checkbox"/>
g. The proposed action may substantially interfere with nesting/breeding, foraging, or over-wintering habitat for the predominant species that occupy or use the project site.	E2m	<input type="checkbox"/>	<input type="checkbox"/>
h. The proposed action requires the conversion of more than 10 acres of forest, grassland or any other regionally or locally important habitat. Habitat type & information source: _____	E1b	<input type="checkbox"/>	<input type="checkbox"/>
i. Proposed action (commercial, industrial or recreational projects, only) involves use of herbicides or pesticides.	D2q	<input type="checkbox"/>	<input type="checkbox"/>
j. Other impacts: _____		<input type="checkbox"/>	<input type="checkbox"/>

8. Impact on Agricultural Resources			
The proposed action may impact agricultural resources. (See Part 1. E.3.a. and b.)		<input checked="" type="checkbox"/> NO	<input type="checkbox"/> YES
<i>If "Yes", answer questions a - h. If "No", move on to Section 9.</i>			
	Relevant Part I Question(s)	No, or small impact may occur	Moderate to large impact may occur
a. The proposed action may impact soil classified within soil group 1 through 4 of the NYS Land Classification System.	E2c, E3b	<input type="checkbox"/>	<input type="checkbox"/>
b. The proposed action may sever, cross or otherwise limit access to agricultural land (includes cropland, hayfields, pasture, vineyard, orchard, etc).	E1a, E1b	<input type="checkbox"/>	<input type="checkbox"/>
c. The proposed action may result in the excavation or compaction of the soil profile of active agricultural land.	E3b	<input type="checkbox"/>	<input type="checkbox"/>
d. The proposed action may irreversibly convert agricultural land to non-agricultural uses, either more than 2.5 acres if located in an Agricultural District, or more than 10 acres if not within an Agricultural District.	E1b, E3a	<input type="checkbox"/>	<input type="checkbox"/>
e. The proposed action may disrupt or prevent installation of an agricultural land management system.	E1 a, E1b	<input type="checkbox"/>	<input type="checkbox"/>
f. The proposed action may result, directly or indirectly, in increased development potential or pressure on farmland.	C2c, C3, D2c, D2d	<input type="checkbox"/>	<input type="checkbox"/>
g. The proposed project is not consistent with the adopted municipal Farmland Protection Plan.	C2c	<input type="checkbox"/>	<input type="checkbox"/>
h. Other impacts: _____		<input type="checkbox"/>	<input type="checkbox"/>

9. Impact on Aesthetic Resources
 The land use of the proposed action are obviously different from, or are in sharp contrast to, current land use patterns between the proposed project and a scenic or aesthetic resource. (Part 1. E.1.a, E.1.b, E.3.h.)
If "Yes", answer questions a - g. If "No", go to Section 10.

NO YES

	Relevant Part I Question(s)	No, or small impact may occur	Moderate to large impact may occur
a. Proposed action may be visible from any officially designated federal, state, or local scenic or aesthetic resource.	E3h	<input type="checkbox"/>	<input type="checkbox"/>
b. The proposed action may result in the obstruction, elimination or significant screening of one or more officially designated scenic views.	E3h, C2b	<input type="checkbox"/>	<input type="checkbox"/>
c. The proposed action may be visible from publicly accessible vantage points: i. Seasonally (e.g., screened by summer foliage, but visible during other seasons) ii. Year round	E3h	<input type="checkbox"/> <input type="checkbox"/>	<input type="checkbox"/> <input type="checkbox"/>
d. The situation or activity in which viewers are engaged while viewing the proposed action is: i. Routine travel by residents, including travel to and from work ii. Recreational or tourism based activities	E3h E2q, E1c	<input type="checkbox"/> <input type="checkbox"/>	<input type="checkbox"/> <input type="checkbox"/>
e. The proposed action may cause a diminishment of the public enjoyment and appreciation of the designated aesthetic resource.	E3h	<input type="checkbox"/>	<input type="checkbox"/>
f. There are similar projects visible within the following distance of the proposed project: 0-1/2 mile 1/2-3 mile 3-5 mile 5+ mile	D1a, E1a, D1f, D1g	<input type="checkbox"/>	<input type="checkbox"/>
g. Other impacts: _____ _____		<input type="checkbox"/>	<input type="checkbox"/>

10. Impact on Historic and Archeological Resources
 The proposed action may occur in or adjacent to a historic or archaeological resource. (Part 1. E.3.e, f. and g.)
If "Yes", answer questions a - e. If "No", go to Section 11.

NO YES

	Relevant Part I Question(s)	No, or small impact may occur	Moderate to large impact may occur
a. The proposed action may occur wholly or partially within, or substantially contiguous to, any buildings, archaeological site or district which is listed on or has been nominated by the NYS Board of Historic Preservation for inclusion on the State or National Register of Historic Places.	E3e	<input type="checkbox"/>	<input type="checkbox"/>
b. The proposed action may occur wholly or partially within, or substantially contiguous to, an area designated as sensitive for archaeological sites on the NY State Historic Preservation Office (SHPO) archaeological site inventory.	E3f	<input type="checkbox"/>	<input type="checkbox"/>
c. The proposed action may occur wholly or partially within, or substantially contiguous to, an archaeological site not included on the NY SHPO inventory. Source: _____	E3g	<input type="checkbox"/>	<input type="checkbox"/>

d. Other impacts: _____ _____		<input type="checkbox"/>	<input type="checkbox"/>
e. If any of the above (a-d) are answered "Yes", continue with the following questions to help support conclusions in Part 3:			
i. The proposed action may result in the destruction or alteration of all or part of the site or property.	E3e, E3g, E3f	<input type="checkbox"/>	<input type="checkbox"/>
ii. The proposed action may result in the alteration of the property's setting or integrity.	E3e, E3f, E3g, E1a, E1b	<input type="checkbox"/>	<input type="checkbox"/>
iii. The proposed action may result in the introduction of visual elements which are out of character with the site or property, or may alter its setting.	E3e, E3f, E3g, E3h, C2, C3	<input type="checkbox"/>	<input type="checkbox"/>

11. Impact on Open Space and Recreation The proposed action may result in a loss of recreational opportunities or a reduction of an open space resource as designated in any adopted municipal open space plan. <input checked="" type="checkbox"/> NO <input type="checkbox"/> YES (See Part 1. C.2.c, E.1.c., E.2.q.) <i>If "Yes", answer questions a - e. If "No", go to Section 12.</i>			
	Relevant Part I Question(s)	No, or small impact may occur	Moderate to large impact may occur
a. The proposed action may result in an impairment of natural functions, or "ecosystem services", provided by an undeveloped area, including but not limited to stormwater storage, nutrient cycling, wildlife habitat.	D2e, E1b, E2h, E2m, E2o, E2n, E2p	<input type="checkbox"/>	<input type="checkbox"/>
b. The proposed action may result in the loss of a current or future recreational resource.	C2a, E1c, C2c, E2q	<input type="checkbox"/>	<input type="checkbox"/>
c. The proposed action may eliminate open space or recreational resource in an area with few such resources.	C2a, C2c, E1c, E2q	<input type="checkbox"/>	<input type="checkbox"/>
d. The proposed action may result in loss of an area now used informally by the community as an open space resource.	C2c, E1c	<input type="checkbox"/>	<input type="checkbox"/>
e. Other impacts: _____ _____		<input type="checkbox"/>	<input type="checkbox"/>

12. Impact on Critical Environmental Areas The proposed action may be located within or adjacent to a critical environmental area (CEA). (See Part 1. E.3.d) <input checked="" type="checkbox"/> NO <input type="checkbox"/> YES <i>If "Yes", answer questions a - c. If "No", go to Section 13.</i>			
	Relevant Part I Question(s)	No, or small impact may occur	Moderate to large impact may occur
a. The proposed action may result in a reduction in the quantity of the resource or characteristic which was the basis for designation of the CEA.	E3d	<input type="checkbox"/>	<input type="checkbox"/>
b. The proposed action may result in a reduction in the quality of the resource or characteristic which was the basis for designation of the CEA.	E3d	<input type="checkbox"/>	<input type="checkbox"/>
c. Other impacts: _____ _____		<input type="checkbox"/>	<input type="checkbox"/>

13. Impact on Transportation
 The proposed action may result in a change to existing transportation systems. NO YES
 (See Part I. D.2.j)
 If "Yes", answer questions a - g. If "No", go to Section 14.

	Relevant Part I Question(s)	No, or small impact may occur	Moderate to large impact may occur
a. Projected traffic increase may exceed capacity of existing road network.	D2j	<input type="checkbox"/>	<input type="checkbox"/>
b. The proposed action may result in the construction of paved parking area for 500 or more vehicles.	D2j	<input type="checkbox"/>	<input type="checkbox"/>
c. The proposed action will degrade existing transit access.	D2j	<input type="checkbox"/>	<input type="checkbox"/>
d. The proposed action will degrade existing pedestrian or bicycle accommodations.	D2j	<input type="checkbox"/>	<input type="checkbox"/>
e. The proposed action may alter the present pattern of movement of people or goods.	D2j	<input type="checkbox"/>	<input type="checkbox"/>
f. Other impacts: _____		<input type="checkbox"/>	<input type="checkbox"/>

14. Impact on Energy
 The proposed action may cause an increase in the use of any form of energy. NO YES
 (See Part I. D.2.k)
 If "Yes", answer questions a - e. If "No", go to Section 15.

	Relevant Part I Question(s)	No, or small impact may occur	Moderate to large impact may occur
a. The proposed action will require a new, or an upgrade to an existing, substation.	D2k	<input type="checkbox"/>	<input type="checkbox"/>
b. The proposed action will require the creation or extension of an energy transmission or supply system to serve more than 50 single or two-family residences or to serve a commercial or industrial use.	D1f, D1q, D2k	<input type="checkbox"/>	<input type="checkbox"/>
c. The proposed action may utilize more than 2,500 MWhrs per year of electricity.	D2k	<input type="checkbox"/>	<input type="checkbox"/>
d. The proposed action may involve heating and/or cooling of more than 100,000 square feet of building area when completed.	D1g	<input type="checkbox"/>	<input type="checkbox"/>
e. Other Impacts: _____		<input type="checkbox"/>	<input type="checkbox"/>

15. Impact on Noise, Odor, and Light
 The proposed action may result in an increase in noise, odors, or outdoor lighting. NO YES
 (See Part I. D.2.m., n., and o.)
 If "Yes", answer questions a - f. If "No", go to Section 16.

	Relevant Part I Question(s)	No, or small impact may occur	Moderate to large impact may occur
a. The proposed action may produce sound above noise levels established by local regulation.	D2m	<input type="checkbox"/>	<input type="checkbox"/>
b. The proposed action may result in blasting within 1,500 feet of any residence, hospital, school, licensed day care center, or nursing home.	D2m, E1d	<input type="checkbox"/>	<input type="checkbox"/>
c. The proposed action may result in routine odors for more than one hour per day.	D2o	<input type="checkbox"/>	<input type="checkbox"/>

d. The proposed action may result in light shining onto adjoining properties.	D2n	<input type="checkbox"/>	<input type="checkbox"/>
e. The proposed action may result in lighting creating sky-glow brighter than existing area conditions.	D2n, E1a	<input type="checkbox"/>	<input type="checkbox"/>
f. Other impacts: _____ _____		<input type="checkbox"/>	<input type="checkbox"/>

16. Impact on Human Health

The proposed action may have an impact on human health from exposure to new or existing sources of contaminants. (See Part 1.D.2.q., E.1. d, f, g, and h.)

NO

YES

If "Yes", answer questions a - m. If "No", go to Section 17.

	Relevant Part I Question(s)	No, or small impact may occur	Moderate to large impact may occur
a. The proposed action is located within 1500 feet of a school, hospital, licensed day care center, group home, nursing home or retirement community.	E1d	<input type="checkbox"/>	<input type="checkbox"/>
b. The site of the proposed action is currently undergoing remediation.	E1g, E1h	<input type="checkbox"/>	<input type="checkbox"/>
c. There is a completed emergency spill remediation, or a completed environmental site remediation on, or adjacent to, the site of the proposed action.	E1g, E1h	<input type="checkbox"/>	<input type="checkbox"/>
d. The site of the action is subject to an institutional control limiting the use of the property (e.g., easement or deed restriction).	E1g, E1h	<input type="checkbox"/>	<input type="checkbox"/>
e. The proposed action may affect institutional control measures that were put in place to ensure that the site remains protective of the environment and human health.	E1g, E1h	<input type="checkbox"/>	<input type="checkbox"/>
f. The proposed action has adequate control measures in place to ensure that future generation, treatment and/or disposal of hazardous wastes will be protective of the environment and human health.	D2t	<input type="checkbox"/>	<input type="checkbox"/>
g. The proposed action involves construction or modification of a solid waste management facility.	D2q, E1f	<input type="checkbox"/>	<input type="checkbox"/>
h. The proposed action may result in the unearthing of solid or hazardous waste.	D2q, E1f	<input type="checkbox"/>	<input type="checkbox"/>
i. The proposed action may result in an increase in the rate of disposal, or processing, of solid waste.	D2r, D2s	<input type="checkbox"/>	<input type="checkbox"/>
j. The proposed action may result in excavation or other disturbance within 2000 feet of a site used for the disposal of solid or hazardous waste.	E1f, E1g E1h	<input type="checkbox"/>	<input type="checkbox"/>
k. The proposed action may result in the migration of explosive gases from a landfill site to adjacent off site structures.	E1f, E1g	<input type="checkbox"/>	<input type="checkbox"/>
l. The proposed action may result in the release of contaminated leachate from the project site.	D2s, E1f, D2r	<input type="checkbox"/>	<input type="checkbox"/>
m. Other impacts: _____ _____		<input type="checkbox"/>	<input type="checkbox"/>

17. Consistency with Community Plans

The proposed action is not consistent with adopted land use plans.
(See Part 1. C.1, C.2. and C.3.)

NO

YES

If "Yes", answer questions a - h. If "No", go to Section 18.

	Relevant Part I Question(s)	No, or small impact may occur	Moderate to large impact may occur
a. The proposed action's land use components may be different from, or in sharp contrast to, current surrounding land use pattern(s).	C2, C3, D1a E1a, E1b	<input type="checkbox"/>	<input type="checkbox"/>
b. The proposed action will cause the permanent population of the city, town or village in which the project is located to grow by more than 5%.	C2	<input type="checkbox"/>	<input type="checkbox"/>
c. The proposed action is inconsistent with local land use plans or zoning regulations.	C2, C2, C3	<input type="checkbox"/>	<input type="checkbox"/>
d. The proposed action is inconsistent with any County plans, or other regional land use plans.	C2, C2	<input type="checkbox"/>	<input type="checkbox"/>
e. The proposed action may cause a change in the density of development that is not supported by existing infrastructure or is distant from existing infrastructure.	C3, D1c, D1d, D1f, D1d, E1b	<input type="checkbox"/>	<input type="checkbox"/>
f. The proposed action is located in an area characterized by low density development that will require new or expanded public infrastructure.	C4, D2c, D2d D2j	<input type="checkbox"/>	<input type="checkbox"/>
g. The proposed action may induce secondary development impacts (e.g., residential or commercial development not included in the proposed action)	C2a	<input type="checkbox"/>	<input type="checkbox"/>
h. Other: _____ _____		<input type="checkbox"/>	<input type="checkbox"/>

18. Consistency with Community Character

The proposed project is inconsistent with the existing community character.
(See Part 1. C.2, C.3, D.2, E.3)

NO

YES

If "Yes", answer questions a - g. If "No", proceed to Part 3.

	Relevant Part I Question(s)	No, or small impact may occur	Moderate to large impact may occur
a. The proposed action may replace or eliminate existing facilities, structures, or areas of historic importance to the community.	E3e, E3f, E3g	<input type="checkbox"/>	<input type="checkbox"/>
b. The proposed action may create a demand for additional community services (e.g. schools, police and fire)	C4	<input type="checkbox"/>	<input type="checkbox"/>
c. The proposed action may displace affordable or low-income housing in an area where there is a shortage of such housing.	C2, C3, D1f D1g, E1a	<input type="checkbox"/>	<input type="checkbox"/>
d. The proposed action may interfere with the use or enjoyment of officially recognized or designated public resources.	C2, E3	<input type="checkbox"/>	<input type="checkbox"/>
e. The proposed action is inconsistent with the predominant architectural scale and character.	C2, C3	<input type="checkbox"/>	<input type="checkbox"/>
f. Proposed action is inconsistent with the character of the existing natural landscape.	C2, C3 E1a, E1b E2g, E2h	<input type="checkbox"/>	<input type="checkbox"/>
g. Other impacts: _____ _____		<input type="checkbox"/>	<input type="checkbox"/>

PRINT FULL FORM

Full Environmental Assessment Form
Part 3 - Evaluation of the Magnitude and Importance of Project Impacts
and
Determination of Significance

Part 3 provides the reasons in support of the determination of significance. The lead agency must complete Part 3 for every question in Part 2 where the impact has been identified as potentially moderate to large or where there is a need to explain why a particular element of the proposed action will not, or may, result in a significant adverse environmental impact.

Based on the analysis in Part 3, the lead agency must decide whether to require an environmental impact statement to further assess the proposed action or whether available information is sufficient for the lead agency to conclude that the proposed action will not have a significant adverse environmental impact. By completing the certification on the next page, the lead agency can complete its determination of significance.

Reasons Supporting This Determination:

To complete this section:

- Identify the impact based on the Part 2 responses and describe its magnitude. Magnitude considers factors such as severity, size or extent of an impact.
- Assess the importance of the impact. Importance relates to the geographic scope, duration, probability of the impact occurring, number of people affected by the impact and any additional environmental consequences if the impact were to occur.
- The assessment should take into consideration any design element or project changes.
- Repeat this process for each Part 2 question where the impact has been identified as potentially moderate to large or where there is a need to explain why a particular element of the proposed action will not, or may, result in a significant adverse environmental impact.
- Provide the reason(s) why the impact may, or will not, result in a significant adverse environmental impact
- For Conditional Negative Declarations identify the specific condition(s) imposed that will modify the proposed action so that no significant adverse environmental impacts will result.
- Attach additional sheets, as needed.

Determination of Significance - Type 1 and Unlisted Actions

SEQR Status: Type 1 Unlisted

Identify portions of EAF completed for this Project: Part 1 Part 2 Part 3

Upon review of the information recorded on this EAF, as noted, plus this additional support information

and considering both the magnitude and importance of each identified potential impact, it is the conclusion of the _____ as lead agency that:

A. This project will result in no significant adverse impacts on the environment, and, therefore, an environmental impact statement need not be prepared. Accordingly, this negative declaration is issued.

B. Although this project could have a significant adverse impact on the environment, that impact will be avoided or substantially mitigated because of the following conditions which will be required by the lead agency:

There will, therefore, be no significant adverse impacts from the project as conditioned, and, therefore, this conditioned negative declaration is issued. A conditioned negative declaration may be used only for UNLISTED actions (see 6 NYCRR 617.d).

C. This Project may result in one or more significant adverse impacts on the environment, and an environmental impact statement must be prepared to further assess the impact(s) and possible mitigation and to explore alternatives to avoid or reduce those impacts. Accordingly, this positive declaration is issued.

Name of Action: PROPOSED TWO LOT RESIDENTIAL SUBDIVISION JORG UWE FRISCHKNECHT

Name of Lead Agency: TOWN OF NEWBURGH PLANNING BOARD

Name of Responsible Officer in Lead Agency: JOHN P. EWASUTYN

Title of Responsible Officer: CHAIRMAN

Signature of Responsible Officer in Lead Agency:

Date:

Signature of Preparer (if different from Responsible Officer)

Date: MARCH 8, 2015

For Further Information:

Contact Person:

Address:

Telephone Number:

E-mail:

For Type 1 Actions and Conditioned Negative Declarations, a copy of this Notice is sent to:

Chief Executive Officer of the political subdivision in which the action will be principally located (e.g., Town / City / Village of)
Other involved agencies (if any)

Applicant (if any)

Environmental Notice Bulletin: <http://www.dec.ny.gov/enb/enb.html>

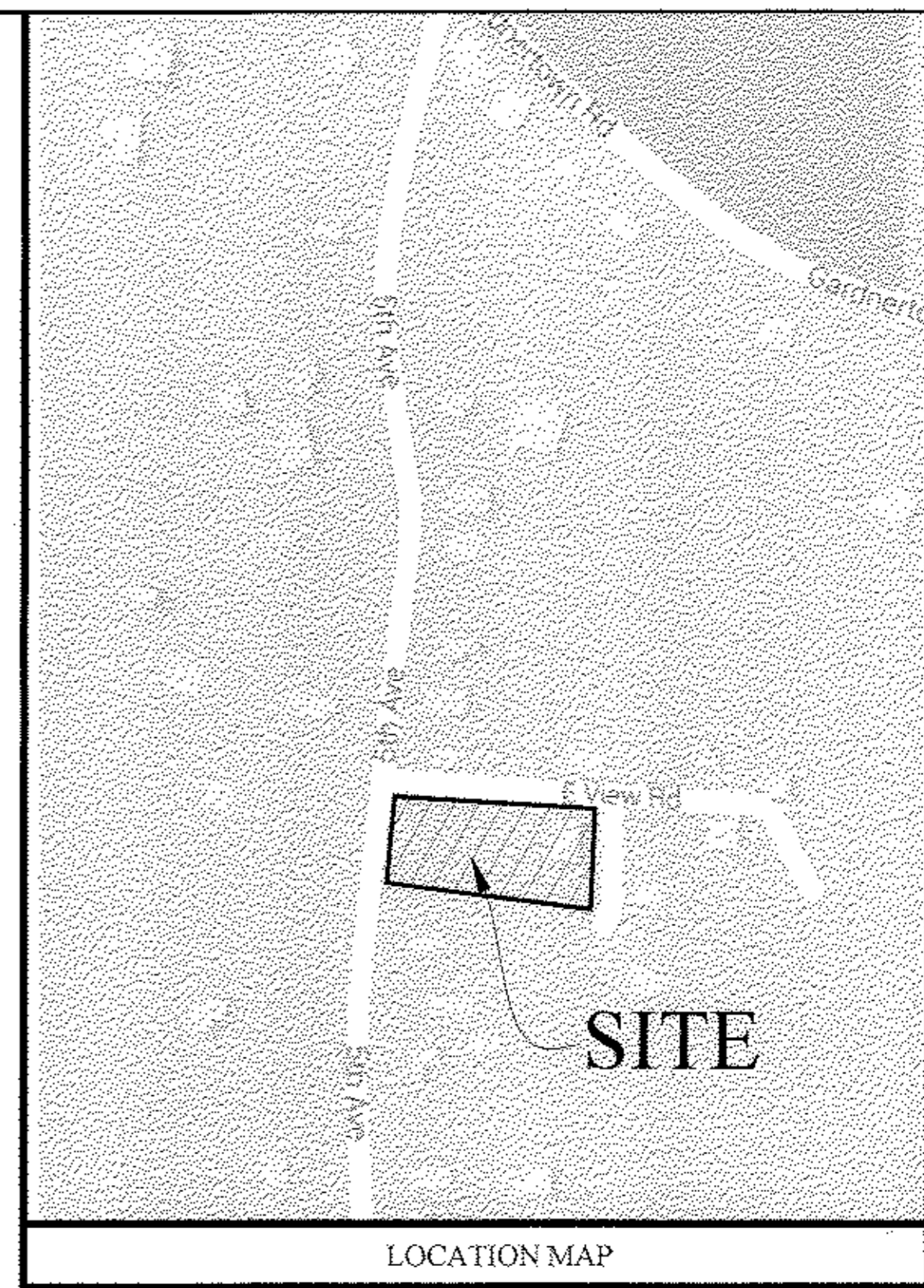
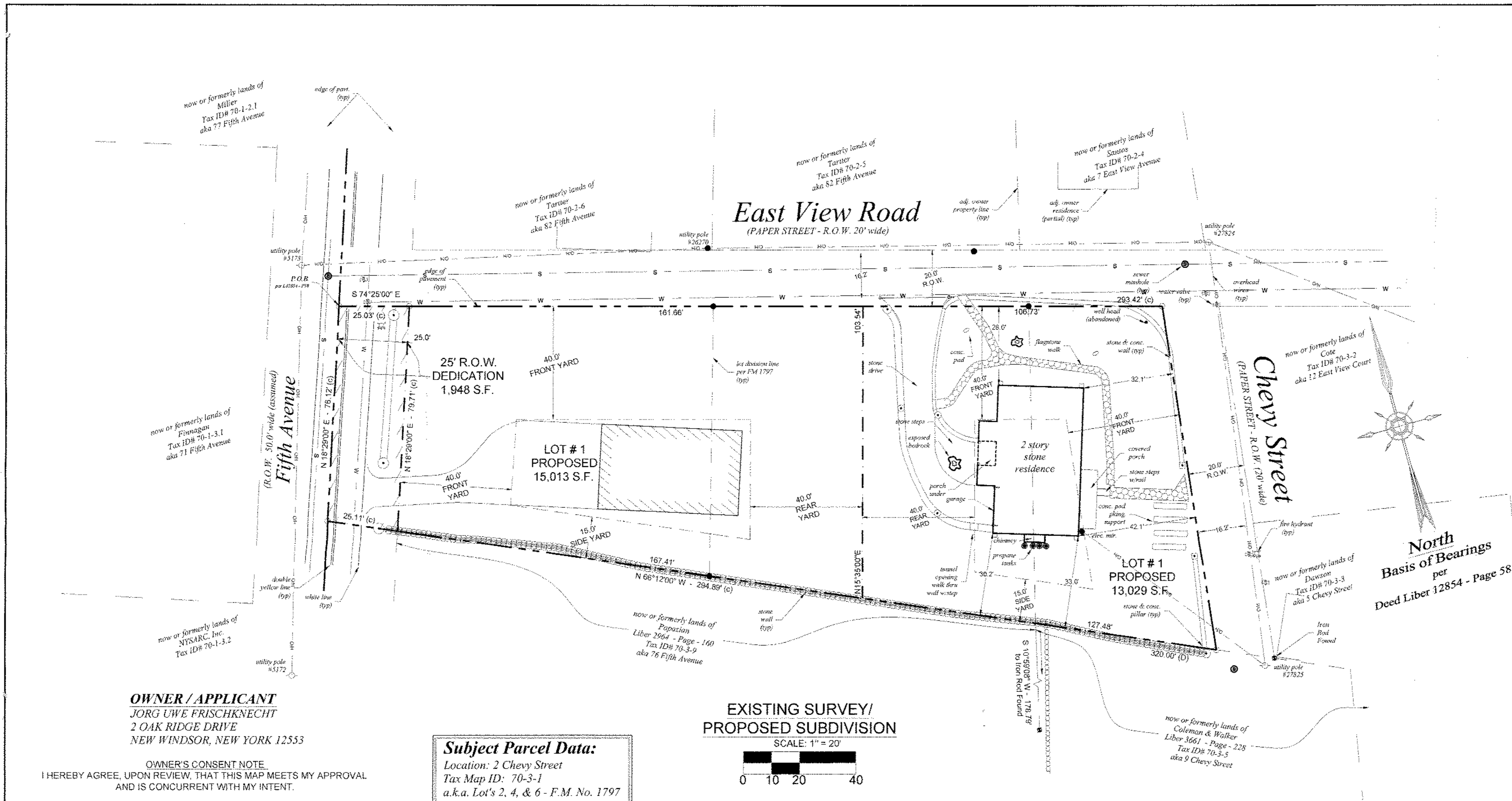

OWNER / APPLICANT
JORG UWE FRISCHKNECHT
 2 OAK RIDGE DRIVE
 NEW WINDSOR, NEW YORK 12553

Subject Parcel Data:
 Location: 2 Chevy Street
 Tax Map ID: 70-3-1
 a.k.a. Lot's 2, 4, & 6 - F.M. No. 1797
 Liber 12854 - Page 58
 Area: 0.643 Ac. (28,000.5 s.f.)

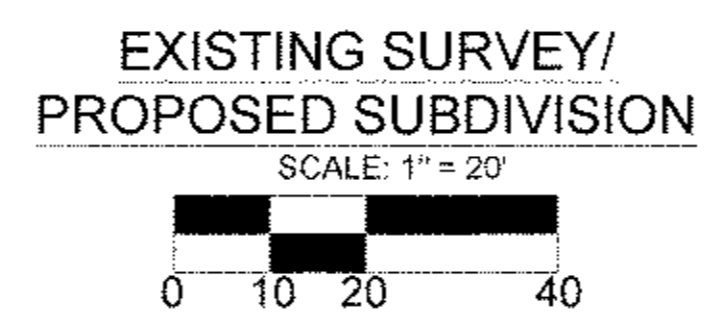

**TOWN OF NEWBURGH R-3 RESIDENTIAL
 LOT SERVICED BY BOTH PUBLIC SEWER AND PUBLIC TOWN WATER SYSTEMS**

	SINGLE FAMILY RESIDENTIAL	LOT # 1 PROVIDED	LOT # 2 PROVIDED
LOT AREA	12,500 S.F.	15,013 S.F.	13,029 S.F.
LOT WIDTH	85 FT.	85 FT.	110 FT. ±
LOT DEPTH	100 FT.	155 FT.	120 FT. ±
FRONT YARD	40 FT.	40 FT. MIN. FIFTH AVENUE 40 FT. MIN. EAST VIEW ROWD	28 FT. ± * EAST VIEW ROAD 32 FT. ± * CHEVY STREET
SIDE YARD (ONE)	15 FT.	15 FT. MIN.	30 FT. ±
(BOTH)	30 FT.	N/A	N/A
REAR YARD	40 FT.	40 FT. MIN.	51 FT. ±
HABITABLE FLOOR AREA	900 S.F.	900 S.F. MIN.	3,300 S.F. ±
LOT BUILDING COVERAGE	15%	15% MAX.	13% ±
BUILDING HEIGHT	35 FT.	35 FT. MAX.	< 35 FT.
LOT SURFACE COVERAGE	30%	30% MAX.	28% ±

* PRE-EXISTING NON-CONFORMING

- SURVEYOR'S NOTES:**
- Copyright © 2014. Jonathan N. Millen, L.L.S. All Rights Reserved. Reproduction or copying of this document may be a violation of copyright law unless permission of the author and/or copyright holder is obtained.
 - Unauthorized alteration of an item in any way, or addition to a survey map for any person, unless acting under the direction of a licensed land surveyor, is a violation of section 7209, subdivision 2, of the New York State Education Law.
 - Only boundary survey maps bearing the surveyor's embossed seal and signature are genuine true and correct copies of the surveyor's original work and opinion. Anything other than copies with an embossed-seal and signature may contain unauthorized and undetectable modifications, deletions, additions, and changes, and are not to be relied upon. A copy of this document without a proper application of the surveyor's embossed seal should be assumed to be an unauthorized copy.
 - Certifications on this boundary survey map signify that the map was prepared in accordance with the current existing Code of Practice for Land Surveys adopted by the New York State Association of Professional Land Surveyors, Inc. The certification is limited to persons for whom the boundary survey map is prepared, to the title company, to the governmental agency, and to the lending institution listed on this boundary survey map.
 - The certifications herein are not transferable.
 - The location of underground improvements or encroachments are not always known and often must be estimated. If any underground improvements or encroachments exist or are shown, the improvements or encroachments are not covered by this certificate.
 - This survey is subject to the findings of a title report and or title search.
 - Surveyed as per deeds, prior survey maps, filed maps, physical evidence and existing ironumentation found at the site.
 - Subject to any conditions, restrictions, covenants and/or right-of-ways/easements of record, if any.

CERTIFICATION NOTES:

This certification is made only to named parties for purchase and/or mortgage of herein delineated property by named purchaser. No responsibility or liability is assumed by surveyor for use of survey for any other purpose including, but not limited to, use of survey for survey affidavit, resale of property, or to any other person not listed in certification, either directly or indirectly, the setting of fences and/or any other structures in or near the property lines. This is a boundary location survey, property corners were not marked.

SURVEYOR'S CERTIFICATION:

I hereby certify to the hereon listed parties that this map represents the results of an actual on the ground field survey, per record description, of the land shown hereon, located at 2 Chevy Street in the Town of Newburgh, County of Orange, State of New York. Completed on 12-18-2014, performed in accordance with the current existing Code of Practice for Land Surveys adopted by the New York State Association of Professional Land Surveyors, Inc., and is to the best of my knowledge, belief and information, accurate and correct. Except as shown hereon: "there are no encroachments either way across property lines; title lines and lines of actual possession are the same".

Signature _____ Date _____
 Jonathan N. Millen, L.L.S.
 196 Sara Lane - Suite 102
 Newburgh, NY 12550

- REFERENCES:**
- Tax Maps for the Town of Newburgh, Orange County, New York. Section 70 Block 3.
 - Various Deeds of Record - Liber and Page as shown:
 - A map entitled, "Map Of Lots Owned By John Whitehead", filed in the Orange County Clerk's Office on April 24, 1959 as Filed Map No. 1797.

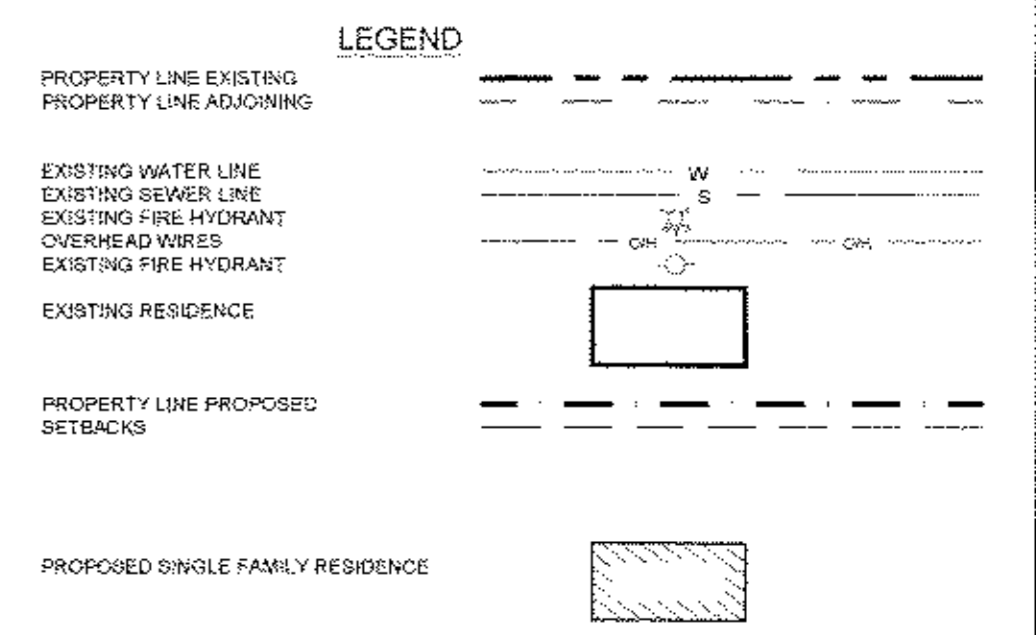
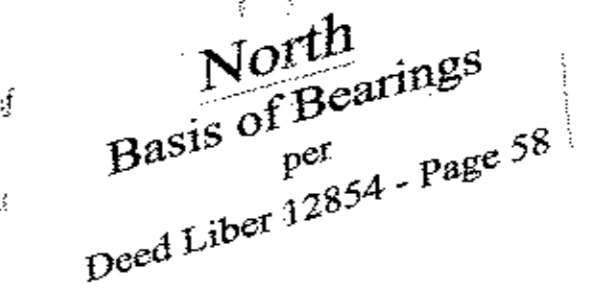

THIS SHEET IS INVALID AND VOID UNLESS ACCOMPANIED BY REMAINING SHEETS IN SET

SURVEY SHEET
 PROPOSED TWO LOT RESIDENTIAL SUBDIVISION
 FOR:
 JORG UWE FRISCHKNECHT
 2 CHEVY LANE (S/B/L: 70-3-1)
 TOWN OF NEWBURGH
 ORANGE COUNTY, NEW YORK

JONATHAN CELLA, P.E.
 51 HUNT ROAD
 WALLKILL, NEW YORK 12589
 (845) 741-0563
 jonathan@cella.com

DATE: 01/26/2015
 SCALE: AS NOTED

DRAWN BY: JIC
 SHEET NO.: 1 OF 3

02/04/2015: FOR SUBMISSION
 PLANNING BOARD

JONATHAN MILLEN, P.L.S.
 N.Y.S. P.E. LIC. NO. 050746

JONATHAN CELLA, P.E.
 N.Y.S. P.E. LIC. NO. 085069

East View Road
(PAPER STREET - R.O.W. 20' wide)

Chevy Street
(PAPER STREET - R.O.W. 20' wide)

Fifth Avenue
(R.O.W. 50.0' wide (assumed))

North
Basis of Bearings
per
Deed Liber 12854 - Page 58

LEGEND

PROPERTY LINE EXISTING	---
PROPERTY LINE ADJOINING	---
EXISTING CONTOURS 2'	---
EXISTING CONTOURS 10'	---
EXISTING WATER LINE	---
EXISTING SEWER LINE	---
EXISTING FIRE HYDRANT	---
EXISTING OVERHEAD WIRES	---
EXISTING FIRE HYDRANT	---
EXISTING RESIDENCE	---
PROPERTY LINE PROPOSED	---
SETBACKS	---
PROPOSED CONTOURS 2'	---
PROPOSED CONTOURS 10'	---
PROPOSED WATER SERVICE CONNECTION	---
PROPOSED SEWER SERVICE CONNECTION	---
PROPOSED SINGLE FAMILY RESIDENCE	---

PROPOSED UTILITY AND GRADING PLAN
SCALE: 1" = 20'

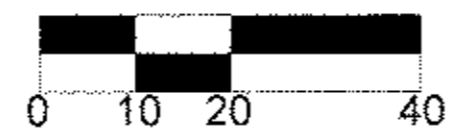

- NOTES**
1. ALL ADJOINING LOTS ON FIFTH AVENUE, EAST VIEW ROAD, AND CHEVY STREET ARE SERVICED BY TOWN WATER AND SEWER.
 2. THE PROPOSED DEVELOPMENT IS CONSTRUCTION OF SINGLE FAMILY RESIDENCES AND WILL ONLY DISTURB 15,000 S.F. ± AND THEREFORE AN EROSION AND SEDIMENTATION CONTROL PLAN SERVES AS THE STORMWATER POLLUTION PREVENTION PLAN (SWPPP) FOR THIS PROJECT.

LOT # 1 EROSION AND SEDIMENTATION CONTROL PLAN
SCALE: 1" = 20'



EROSION AND SEDIMENTATION CONTROL PLAN LEGEND

- SILT FENCE
- TOPSOIL STOCKPILE
- STABILIZED CONSTRUCTION ENTRANCE

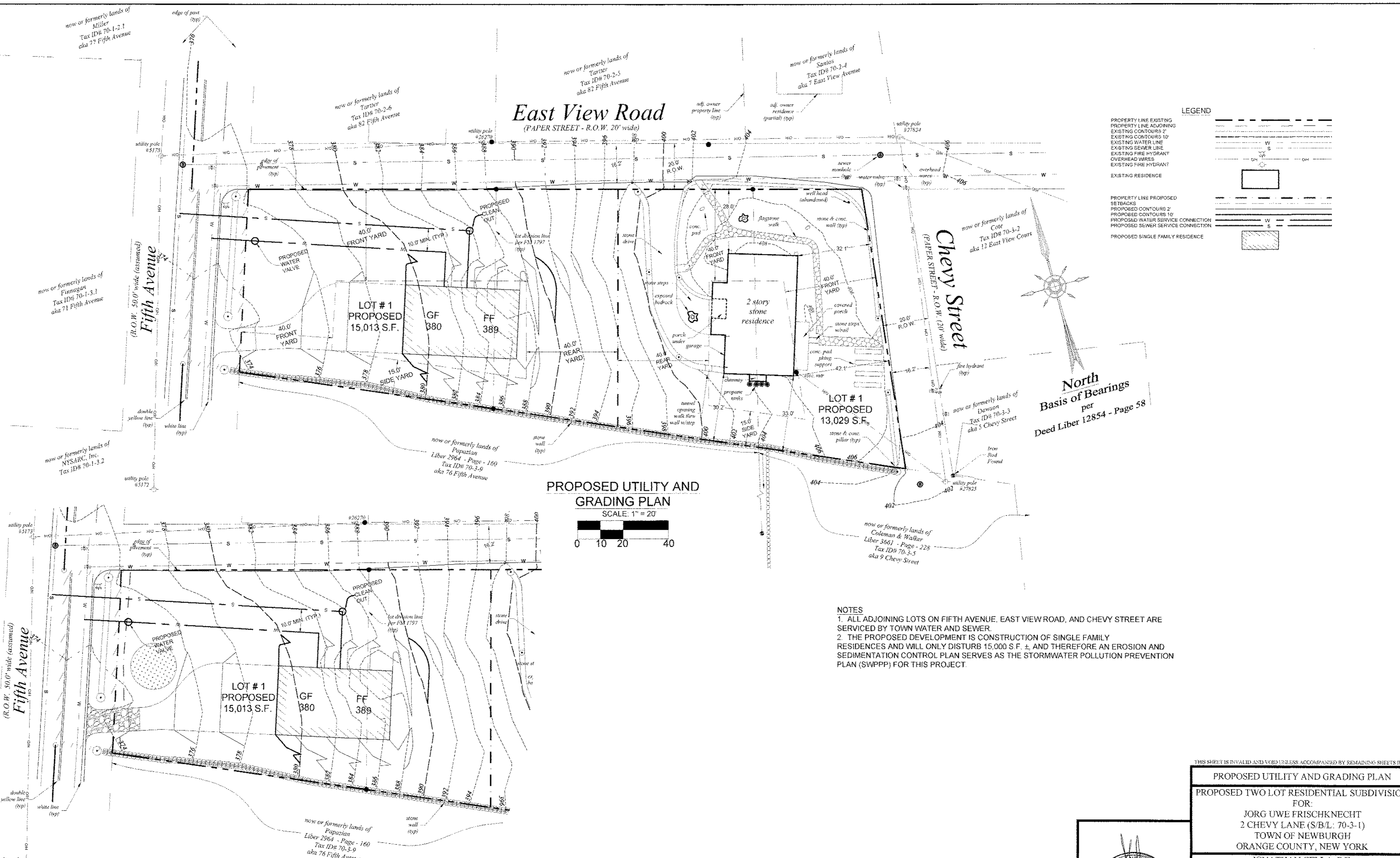
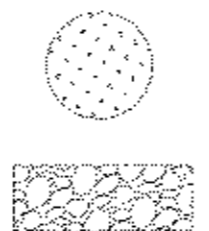

JONATHAN CELLA, P.E.
N.Y.S. P.E. LIC. NO. 085069

THIS SHEET IS INVALID AND VOID UNLESS ACCOMPANIED BY REMAINING SHEETS IN SET

PROPOSED UTILITY AND GRADING PLAN		
PROPOSED TWO LOT RESIDENTIAL SUBDIVISION FOR:		
JORG UWE FRISCHKNECHT 2 CHEVY LANE (S/B/L: 70-3-1) TOWN OF NEWBURGH ORANGE COUNTY, NEW YORK		
JONATHAN CELLA, P.E. 51 HUNT ROAD WALKKILL, NEW YORK 12589		
DATE: 01/26/2015	DRAWN BY: JKC	
SCALE: AS NOTED	SHEET NO.:	2 OF 3
03/09/2015: FOR ZONING BOARD SUBMISSION		

PLANNING BOARD

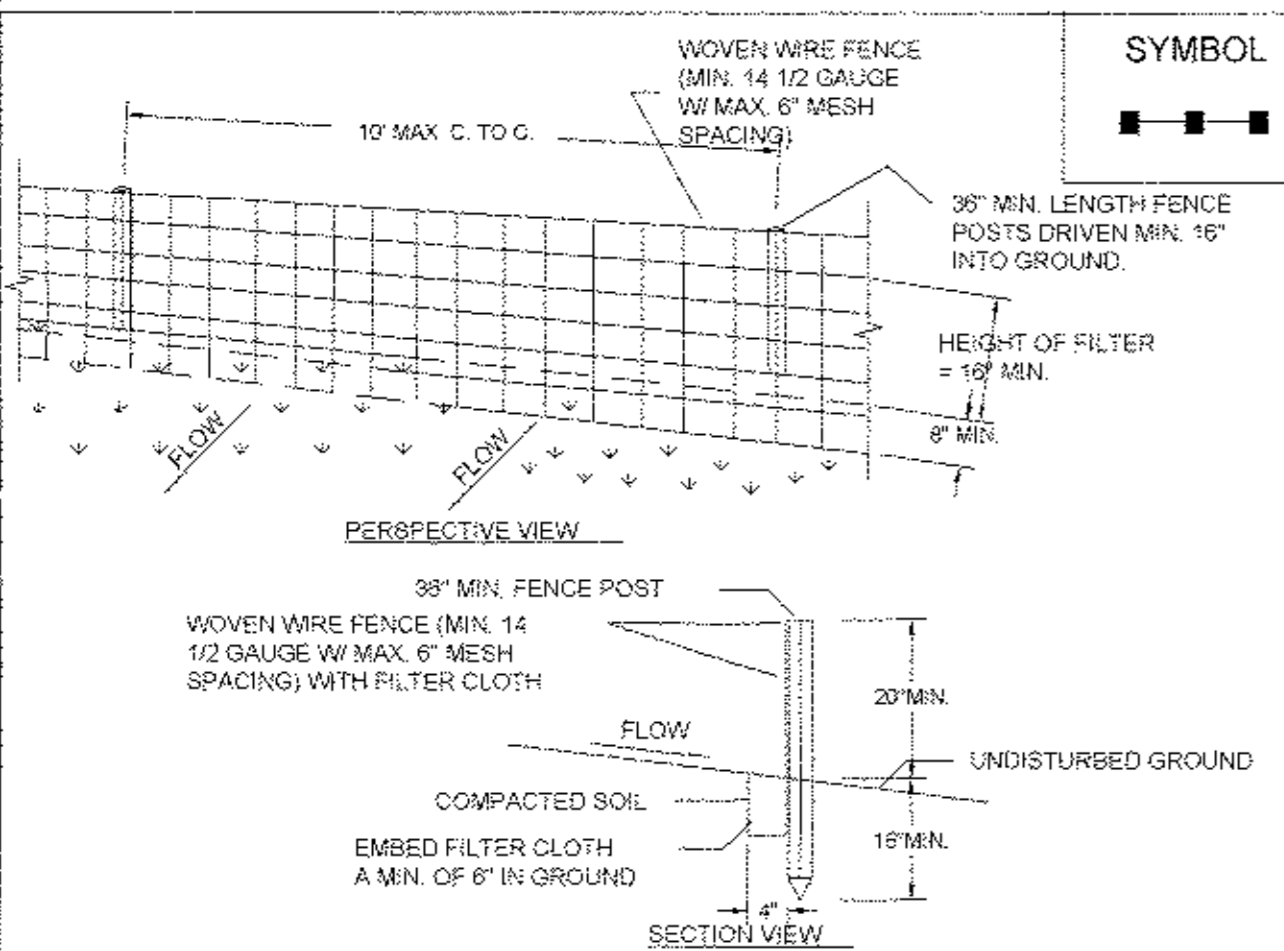
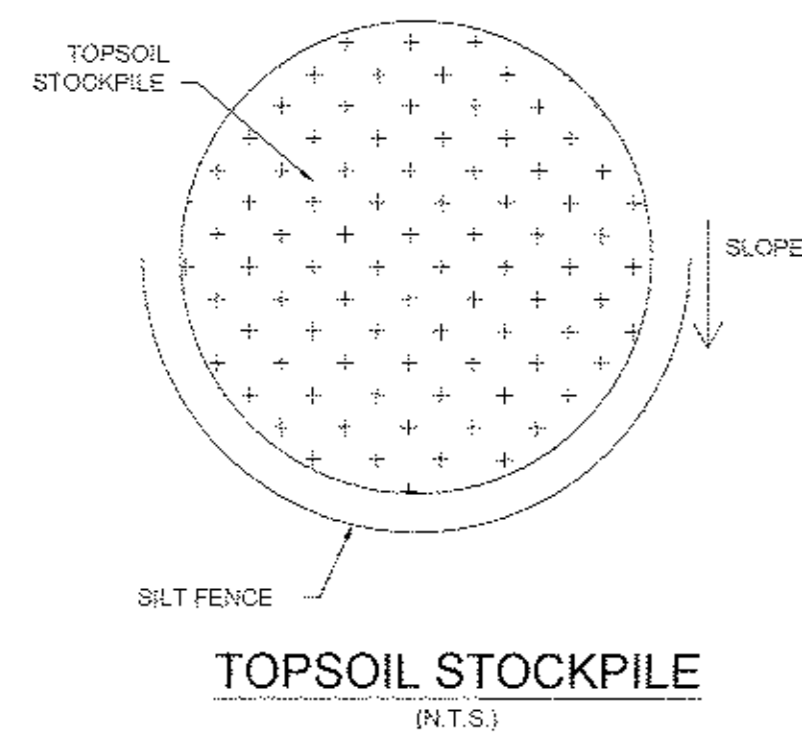

CONSTRUCTION SPECIFICATIONS

- WOVEN WIRE FENCE TO BE FASTENED SECURELY TO FENCE POSTS WITH WIRE TIES OR STAPLES. POSTS SHALL BE STEEL EITHER "T" OR "U" TYPE OR HARDWOOD.
- FILTER CLOTH TO BE TO BE FASTENED SECURELY TO WOVEN WIRE FENCE WITH TIES SPACED EVERY 24" AT TOP AND MID SECTION. FENCE SHALL BE WOVEN WIRE, 12 1/2 GAUGE, 6" MAXIMUM MESH OPENING.
- WHEN TWO SECTIONS OF FILTER CLOTH ADJOIN EACH OTHER THEY SHALL BE OVERLAPPED BY SIX INCHES AND FOLDED. FILTER CLOTH SHALL BE EITHER FILTER A, MIRAFI 100X, STABILINKA T140N, OR APPROVED EQUIVALENT.
- PREFABRICATED UNITS SHALL BE GEOTAB, ENVROFENCE, OR APPROVED EQUIVALENT.
- MAINTENANCE SHALL BE PERFORMED AS NEEDED AND MATERIAL REMOVED WHEN "BULGES" DEVELOP IN THE SILT FENCE.

U.S. DEPARTMENT OF AGRICULTURE
NATURAL RESOURCES CONSERVATION SERVICE
NEW YORK STATE DEPARTMENT OF ENVIRONMENTAL CONSERVATION
NEW YORK STATE SOIL & WATER CONSERVATION COMMITTEE

SILT FENCE

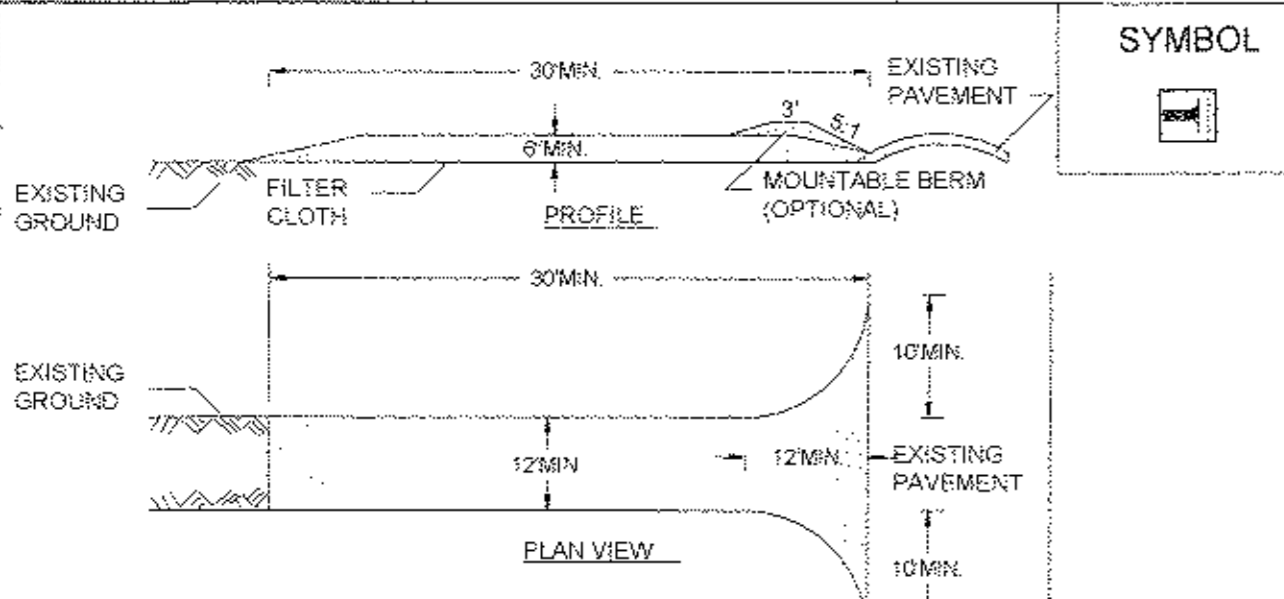

CONSTRUCTION SPECIFICATIONS

- STONE SIZE - USE 2" STONE, OR RECLAIMED OR RECYCLED CONCRETE EQUIVALENT.
- LENGTH - NOT LESS THAN 50 FEET (EXCEPT ON A SINGLE RESIDENCE LOT WHERE A 30 FOOT MINIMUM LENGTH WOULD APPLY).
- THICKNESS - NOT LESS THAN SIX (6) INCHES.
- WIDTH - TWELVE (12) FOOT MINIMUM, BUT NOT LESS THAN THE FULL WIDTH AT POINTS WHERE INGRESS OR EGRESS OCCURS. TWENTY-FOUR (24) FOOT IF SINGLE ENTRANCE TO SITE.
- FILTER CLOTH - WILL BE PLACED OVER THE ENTIRE AREA PRIOR TO PLACING OF STONE.
- SURFACE WATER - ALL SURFACE WATER FLOWING OR DIVERTED TOWARD CONSTRUCTION ENTRANCES SHALL BE PIPED ACROSS THE ENTRANCE. IF PIPING IS IMPRACTICAL, A MOUNTABLE BERM WITH 6:1 SLOPES WILL BE PERMITTED.
- MAINTENANCE - THE ENTRANCE SHALL BE MAINTAINED IN A CONDITION WHICH WILL PREVENT TRACKING OR FLOWING OF SEDIMENT ONTO PUBLIC RIGHTS-OF-WAY. ALL SEDIMENT SPILLED, DROPPED, WASHED OR TRACED ONTO PUBLIC RIGHTS-OF-WAY MUST BE REMOVED IMMEDIATELY.
- WHEN WASHING IS REQUIRED, IT SHALL BE DONE ON A AREA STABILIZED WITH STONE AND WHICH DRAINS INTO AN APPROVED SEDIMENT TRAPPING DEVICE.
- PERIODIC INSPECTION AND NEEDED MAINTENANCE SHALL BE PROVIDED AFTER EACH RAIN.

U.S. DEPARTMENT OF AGRICULTURE
NATURAL RESOURCES CONSERVATION SERVICE
NEW YORK STATE DEPARTMENT OF ENVIRONMENTAL CONSERVATION
NEW YORK STATE SOIL & WATER CONSERVATION COMMITTEE

STABILIZED CONSTRUCTION ENTRANCE

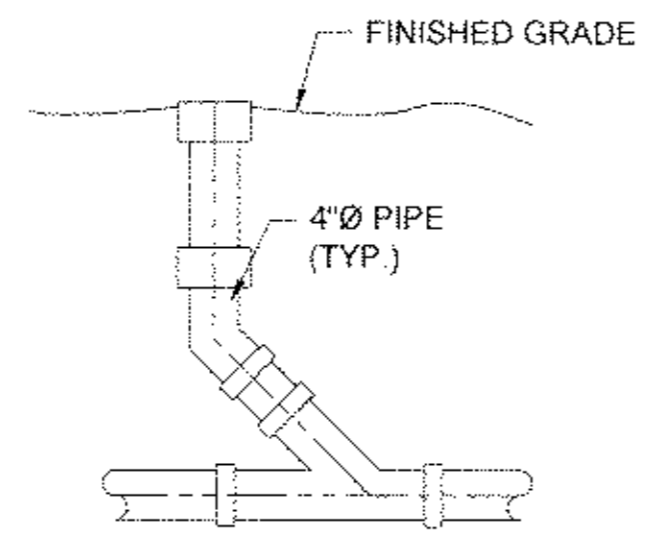

CLEANOUT DETAIL
(N.T.S.)

CLEANOUTS SHALL BE INSTALLED BEFORE ALL PIPE BENDS BETWEEN THE SEPTIC TANK AND DISTRIBUTION BOX AND OR AT EVERY 75' OF STRAIGHT PIPE. CLEANOUTS SHALL NOT BE USED WITH PUMP CHAMBERS.

TEMPORARY VEGETATION NOTES

- TEMPORARY VEGETATION SHALL BE USED TO PROTECT AREAS IN EXCESS OF 1/2 ACRE EXPOSED FOR PERIODS OF TWO (2) WEEKS BEFORE OR DURING DEVELOPMENT.
- FIFTY (50) LBS OF NITROGEN, 50 LBS OF APPROVED GRAIN SEED AND 2 TONS OF HAY MULCH PER ACRE OR
 - ON AREAS THAT WILL BE EXPOSED FOR SHORT PERIODS OF TIME AND WHERE WEATHER CONDITIONS ARE CONDUCIVE TO AIRBORNE SAND, TRAPS TO CONTROL SUCH SAND SHALL BE INSTALLED AS DIRECTED.
 - ON AREAS SUCH AS TEMPORARY ROADWAYS, WHEN DRY CONDITIONS PREVAIL, THE CONTRACTOR SHALL BE REQUIRED TO APPLY WATER OR CALCIUM CHLORIDE AS REQUIRED TO PREVENT DUST DURING CONSTRUCTION ACTIVITIES.

EROSION CONTROL STANDARD NOTES

- EXCAVATION, FILLING, GRADING, AND STRIPPING ACTIVITIES SHALL BE UNDERTAKEN IN SUCH A MANNER AS TO MINIMIZE THE POTENTIAL OF EROSION AND SEDIMENT AND THE THREAT TO THE HEALTH, SAFETY AND WELFARE OF NEIGHBORING PROPERTY OWNERS AND THE GENERAL PUBLIC.
- SITE PREPARATION AND CONSTRUCTION SHALL BE FITTED TO THE VEGETATION, TOPOGRAPHY, AND OTHER NATURAL FEATURES OF THE SITE AND SHALL PRESERVE AS MANY OF THESE FEATURES AS POSSIBLE.
- THE CONTROL OF EROSION AND SEDIMENT SHALL BE A CONTINUOUS PROCESS UNDERTAKEN AS NECESSARY PRIOR TO, DURING AND AFTER SITE PREPARATION AND CONSTRUCTION.
- THE SMALLEST PRACTICAL AREA OF LAND SHALL BE EXPOSED BY SITE PREPARATION AT ANY GIVEN TIME.
- THE EXPOSURE OF AREAS BY SITE PREPARATION SHALL BE KEPT TO THE SHORTEST PRACTICAL PERIOD OF TIME PRIOR TO THE CONSTRUCTION OF STRUCTURES OR IMPROVEMENTS OR THE RESTORATION OF THE EXPOSED AREAS TO AN ATTRACTIVE NATURAL CONDITION.
- MULCHING OR TEMPORARY VEGETATION SUITABLE TO THE SITE SHALL BE USED WHERE NECESSARY TO PROTECT AREAS EXPOSED BY SITE PREPARATION, AND PERMANENT VEGETATION WHICH IS WELL ADAPTED TO THE SITE SHALL BE INSTALLED AS SOON AS PRACTICAL.
- WHERE SLOPES ARE TO BE REVEGETATED IN AREAS EXPOSED BY SITE PREPARATION, THE SLOPES SHALL NOT BE OF SUCH STEEPNESS THAT VEGETATION CANNOT BE READILY ESTABLISHED OR THAT PROBLEMS OF EROSION OR SEDIMENT MAY RESULT.
- SITE PREPARATION AND CONSTRUCTION SHALL NOT ADVERSELY AFFECT THE FREE FLOW OF WATER BY ENCROACHING ON, BLOCKING OR RESTRICTING WATERCOURSES.
- ALL FILL MATERIAL SHALL BE OF COMPOSITION SUITABLE FOR THE ULTIMATE USE OF THE FILL, FREE OF RUBBISH, AND CAREFULLY RESTRICTED IN ITS CONTENT OF BRUSH, STUMPS, TREE DEBRIS, ROCKS, FROZEN MATERIAL, AND SOFT OR EASILY COMPRESSIBLE MATERIAL.
- FILL MATERIAL SHALL BE COMPACTED SUFFICIENTLY TO PREVENT PROBLEMS OF EROSION, AND WHERE THE MATERIAL IS TO SUPPORT STRUCTURES, IT SHALL BE COMPACTED TO A MINIMUM OF NINETY PERCENT (90%) OF STANDARD PROCTOR WITH PROPER MOISTURE CONTROL.
- ALL TOPSOIL WHICH IS EXCAVATED FROM A SITE SHALL BE STOCKPILED AND USED FOR THE RESTORATION OF THE SITE, AND SUCH STOCKPILES, WHERE NECESSARY, SHALL BE SEEDED OR OTHERWISE TREATED TO MINIMIZE THE EFFECTS OF EROSION.
- PRIOR TO, DURING AND AFTER SITE PREPARATION AND CONSTRUCTION, AN INTEGRATED DRAINAGE SYSTEM SHALL BE PROVIDED WHICH AT ALL TIMES MINIMIZES EROSION, SEDIMENT, HAZARDS OF SLOPE INSTABILITY, AND ADVERSE EFFECTS ON NEIGHBORING PROPERTY OWNERS.
- THE NATURAL DRAINAGE SYSTEM SHALL GENERALLY BE PRESERVED IN PREFERENCE TO MODIFICATIONS OF THIS SYSTEM, EXCEPTING WHERE SUCH MODIFICATIONS ARE NECESSARY TO REDUCE LEVELS OF EROSION AND SEDIMENT AND ADVERSE EFFECTS ON NEIGHBORING PROPERTY OWNERS.
- ALL DRAINAGE SYSTEMS SHALL BE DESIGNED TO HANDLE ADEQUATELY ANTICIPATED FLOWS, BOTH WITHIN THE SITE AND FROM UPSTREAM DRAINAGE BASIN.
- SUFFICIENT GRADES AND DRAINAGE FACILITIES SHALL BE PROVIDED TO PREVENT THE PONDING OF WATER, UNLESS SUCH PONDING IS PROPOSED WITHIN SITE PLANS, IN WHICH EVENT THERE SHALL BE SUFFICIENT WATER FLOW TO MAINTAIN PROPOSED WATER LEVELS AND TO AVOID STAGNATION.
- THERE SHALL BE PROVIDED WHERE NECESSARY TO MINIMIZE EROSION AND SEDIMENT SUCH MEASURES AS BENCHES, BERMS, TERRACES, DIVERSIONS AND SEDIMENT, DEBRIS AND RETENTION BASINS.
- DRAINAGE SYSTEMS, PLAN TINGS AND OTHER EROSION OR SEDIMENT CONTROL DEVICES SHALL BE MAINTAINED AS FREQUENTLY AS NECESSARY TO PROVIDE ADEQUATE PROTECTION AGAINST EROSION AND SEDIMENT AND TO ENSURE THAT THE FREE FLOW OF WATER IS NOT OBSTRUCTED BY THE ACCUMULATION OF SILT, DEBRIS OR OTHER MATERIAL OR BY STRUCTURAL DAMAGE.

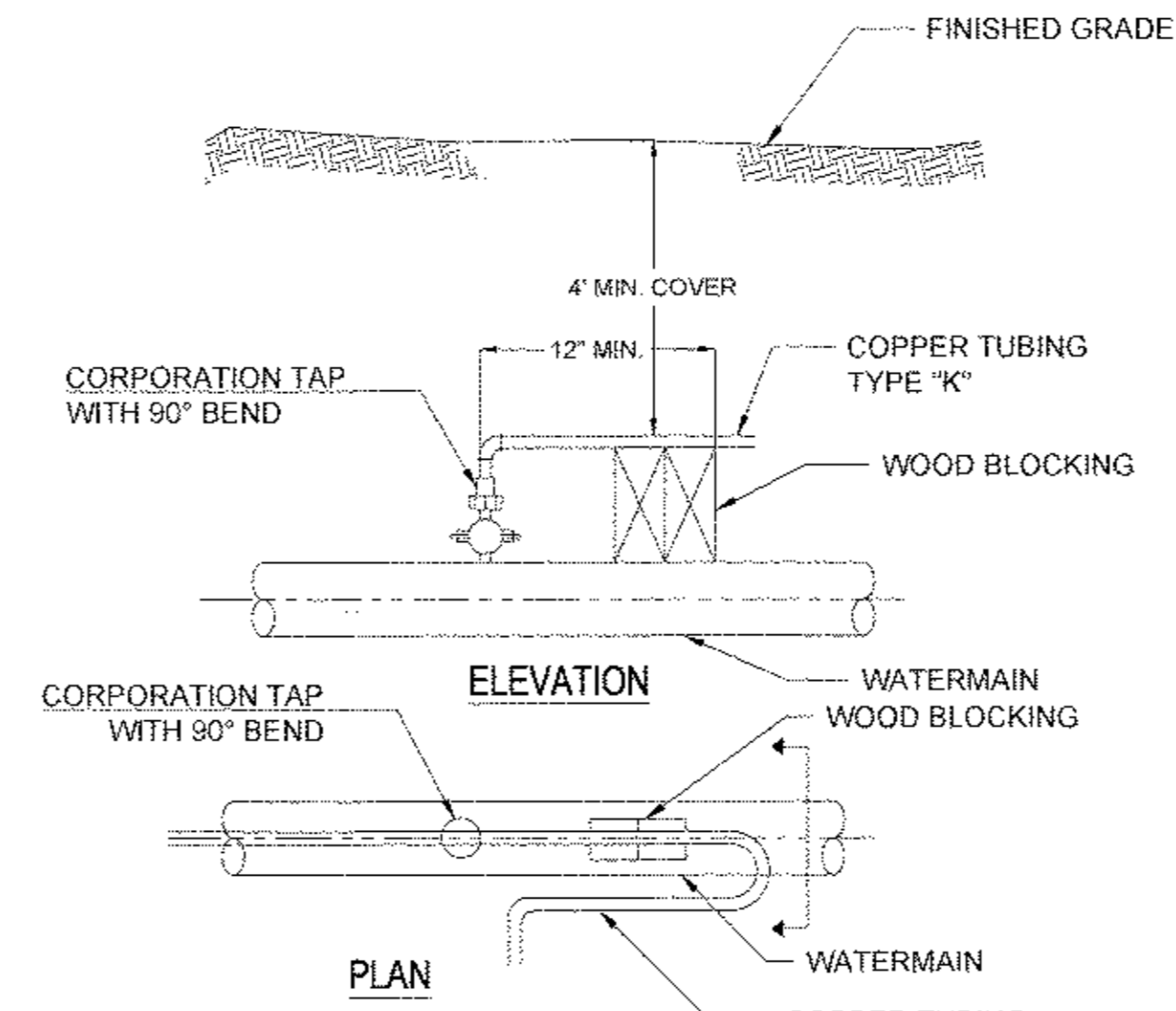

WATER SERVICE TAP
NOT TO SCALE

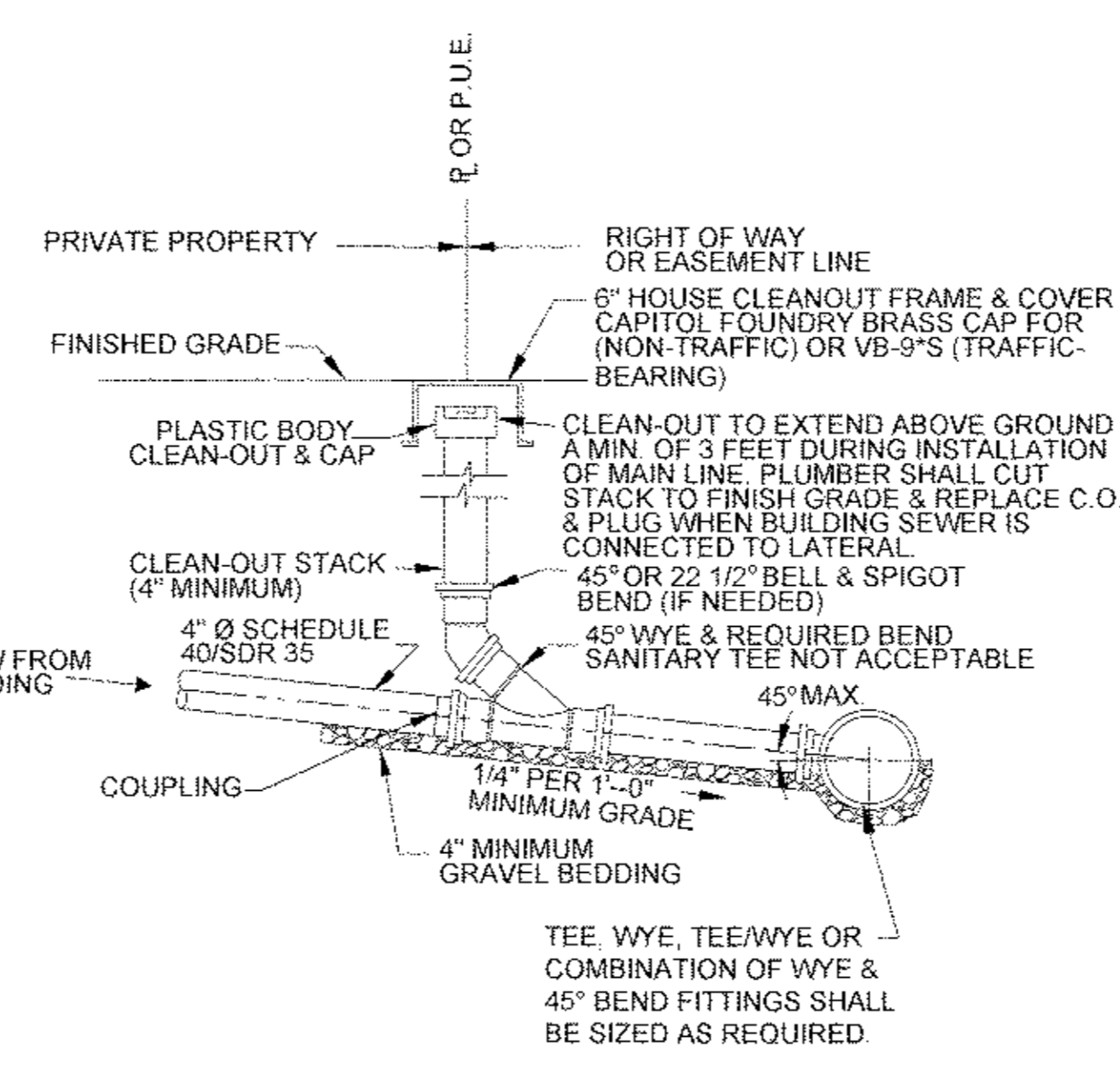
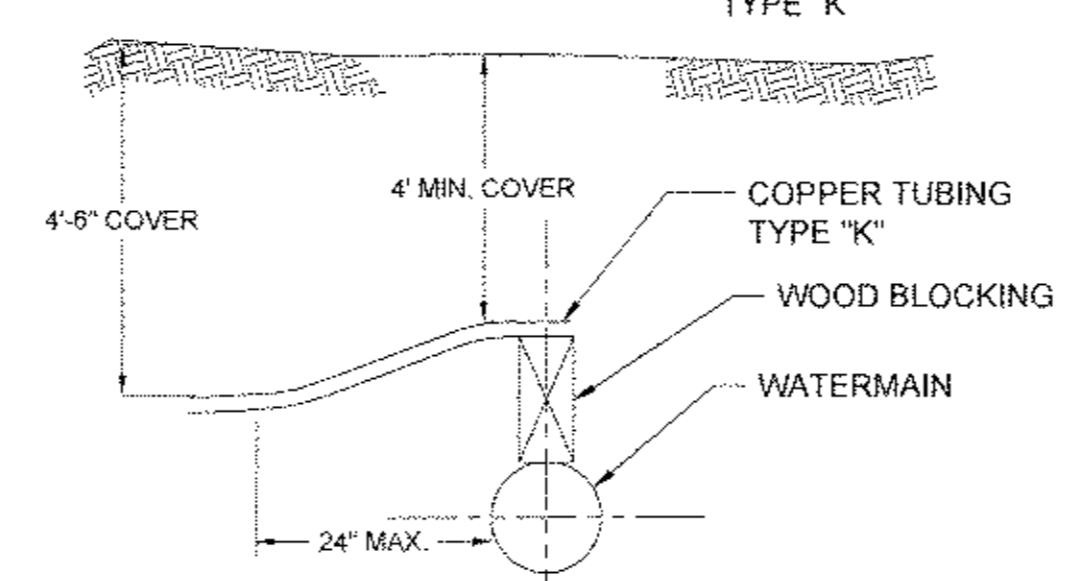

BUILDING SEWER SERVICE CONNECTION
NOT TO SCALE

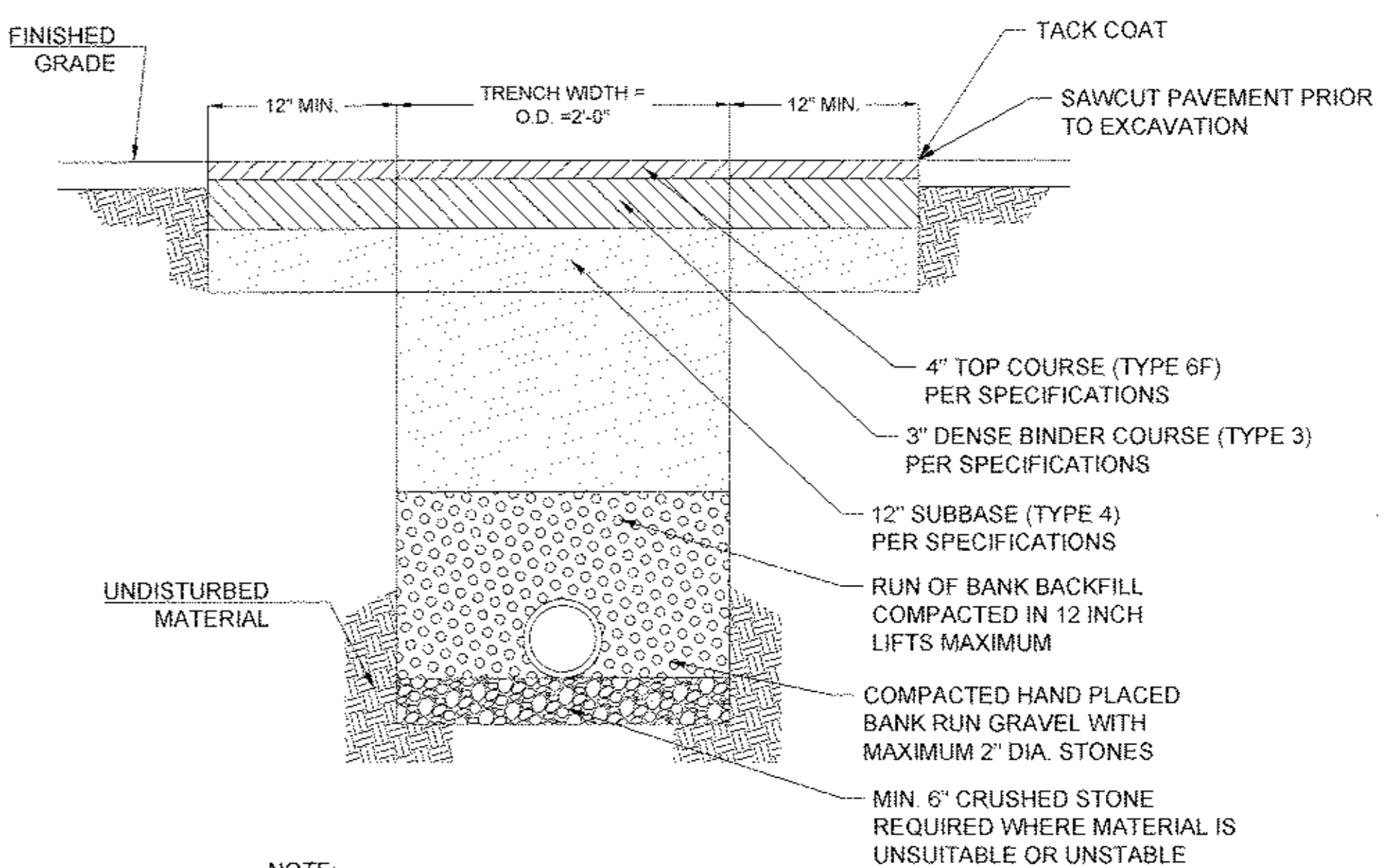

NOTE: MAXIMUM DEPTH OF COVER NOT TO EXCEED 6' WITHOUT APPROVAL OF THE TOWN WATER SUPERINTENDENT.

BACKFILL AND PAVEMENT RESTORATION
NOT TO SCALE

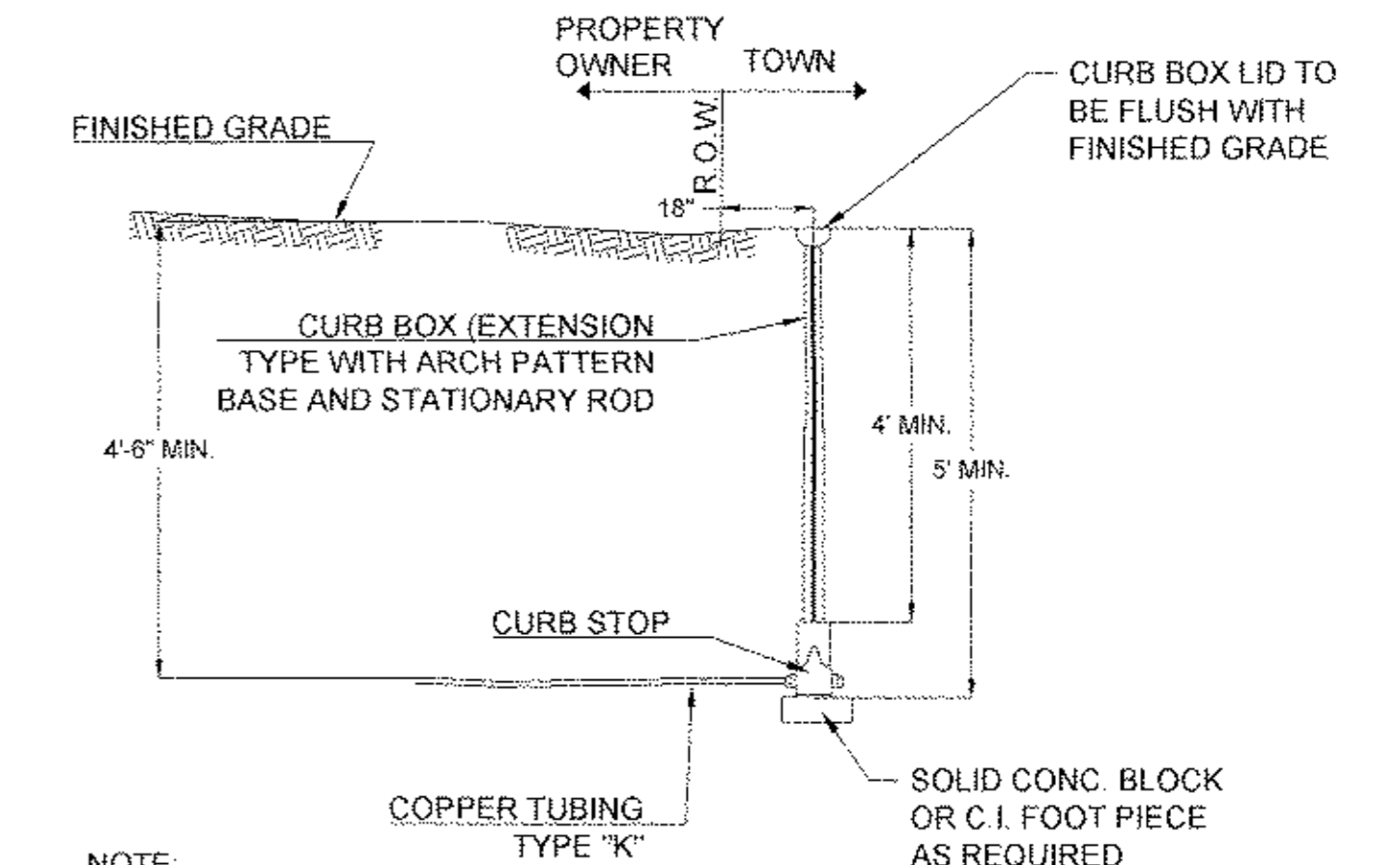

NOTE: PROPOSED LOCATION OF CURB BOXES TO BE FIELD LOCATED (STAKED) AND APPROVED BY WATER SUPERINTENDENT PRIOR TO INSTALLATION.

WATER SERVICE CURB BOX
NOT TO SCALE

THIS SHEET IS INVALID AND VOID UNLESS ACCOMPANIED BY REMAINING SHEETS IN SET.

DETAILS AND NOTES		
PROPOSED TWO LOT RESIDENTIAL SUBDIVISION FOR: JORG UWE FRISCHKNECHT 2 CHEVY LANE (S/B/L: 70-3-1) TOWN OF NEWBURGH ORANGE COUNTY, NEW YORK		
JONATHAN CELLA, P.E. 51 HUNT ROAD WALLKILL, NEWYORK 12589		
DATE: 01/26/2013	(845) 743-0963 jonathancella@wallkill.com	DRAWN BY: JIC
SCALE: AS NOTED		SHEET NO.: 3 OF 3
03/09/2015: FOR PLANNING BOARD SUBMISSION		

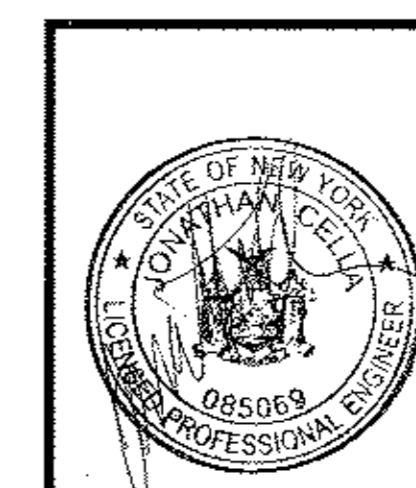

JONATHAN CELLA, P.E.
N.Y.S. P.E. LIC. NO. 085069